

Ride Regina. Be one of us!



PERFORMANCE IN MOTION

General Catalogue 2020

PC13D20EC

Our history is our future.

In 2019, Regina will celebrate its 100th anniversary. The company was founded in 1919, initially manufacturing chains and freewheels for bicycles. In those days, the “Milano-Sanremo” race was the annual happening; the “Giro d’Italia” was a show for everybody and the “Tour de France” was already a sensational event. Regina was always present, collecting victories and successes. Ninety percent of the racing teams used components and parts made by Regina.

“Since 1919.”

The production of motorcycle chains began in 1939: Regina was the first chains manufacturer in the world with a serious approach to the motorcycle field. After the Second World War, companies such as Guzzi and Gilera came out with an intuitive move to offer new affordable models, anticipating the scooter era and innovating the market with light bikes such as the “Guzzino”. Garelli was offering the “Mosquito” and many other companies produced small engines of 25-50cc to fit on bicycles. This was the birth of the “moped”, the first real integral motorisation for Italians.

Close behind followed Piaggio’s “Vespa” and

“100%
Made in Italy.”

Innocenti’s “Lambretta”. The original design of Lambretta did not have a transmission by chain, but after the problems experienced with the cardan transmission, the company asked for a solution from Regina which, with its skill, solved the problem and reached success with this new method of power transmission. As the motorcycle market was thriving, new companies approached the market: Benelli regained strength and MotoMorini, Ducati, the 4-cylinder Gilera and the Verghera of MV competed with the 8-cylinder from Mandello Guzzi. In the 80’s, Italy was a leader in motorcycle manufacturing. And Regina was part of this success: an Italian company proudly representing the Italian ability of providing technology for the world.

Hundreds of Italian and foreign champions such as Ruffo, Ubbiali, Nieto, Duke, Surtees, Hailwood, Agostini, Lucchinelli, Lowson, Capirossi, Stoner, Roberts,

Bayliss, Biaggi, Lorenzo, Rossi, Everts, Cairoli, Herlings, Eriksson, Prado, and Remes appreciated the high quality of the Regina products, as well as the “Regina Race

by combining innovation with an outstanding and consistently high quality level has allowed Regina to be a market leader, enabling it to serve leading motorcycle manufacturers such as Aprilia, BMW, Ducati, Harley-Davidson, Honda, KTM and Yamaha, just to name a few.

“The chain of
Champions”

Over
345 Times
World
Champion



Service Team” which is today, and has been ever since, present on all European and US race tracks and circuits, providing significant assistance to the achievement of world records and titles . Over the period of 100

years, many championships in each discipline and category have been won, both in the road and off-road segments, with nearly 350 World Championship titles so far.

Regina’s key to success is rooted in a close cooperation with the most prominent motorcycle manufacturers. Understanding the needs of OEMs and meeting their requirements

In addition, being a preferred partner in racing allowed Regina to use races as the test ground to develop the ultimate product characteristics and technology in manufacturing. Exclusive technical solutions such as the Z-Ring, the Chromized Pin and the Shaped Bushing are just some of the latest milestones in Regina’s portfolio...and more have to come. The application of these technologies to mass production and the premium quality level made the real

“Original equipment
on top bike
manufacturers.”

difference between Regina and other players, making Regina the undisputed world leader in research, development and production of chains for every type of application.

Regina Chain, performance in motion since 1919.

Index

5	What is a chain?	21
6	Regina chain range	22
9	Connecting links range	24
10	Z-RING	
	PROFESSIONAL ROAD	25
12	Sportbike	26
13	Touring Street	27
14	Urban Chain Kit	
16	SHAPED BUSHING	28
	PROFESSIONAL OFF-ROAD	
18	Cross Supermotard	
19	Enduro	
20	Adventure	

Black Dual

REGINA EXTRA

**SPECIALTIES
KART**

Regina Classic
CHAIN

TIMING

TOOLS

Merchandising

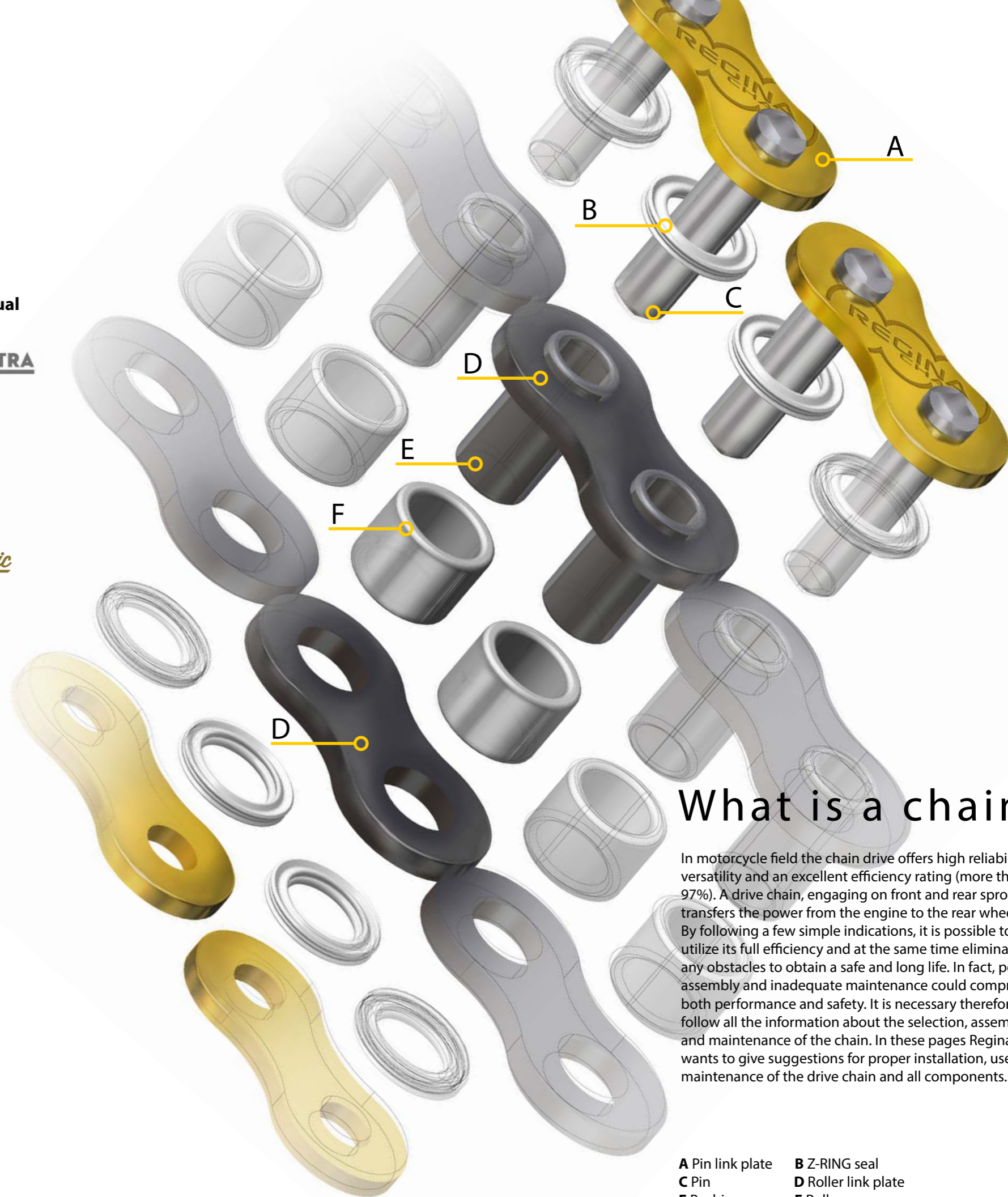

What is a chain?

In motorcycle field the chain drive offers high reliability, versatility and an excellent efficiency rating (more than 97%). A drive chain, engaging on front and rear sprockets, transfers the power from the engine to the rear wheel. By following a few simple indications, it is possible to utilize its full efficiency and at the same time eliminate any obstacles to obtain a safe and long life. In fact, poor assembly and inadequate maintenance could compromise both performance and safety. It is necessary therefore to follow all the information about the selection, assembly and maintenance of the chain. In these pages Regina wants to give suggestions for proper installation, use and maintenance of the drive chain and all components.

- A** Pin link plate
- B** Z-RING seal
- C** Pin
- D** Roller link plate
- E** Bushing
- F** Roller

ROAD

OFF-ROAD



PRODUCT RANGE

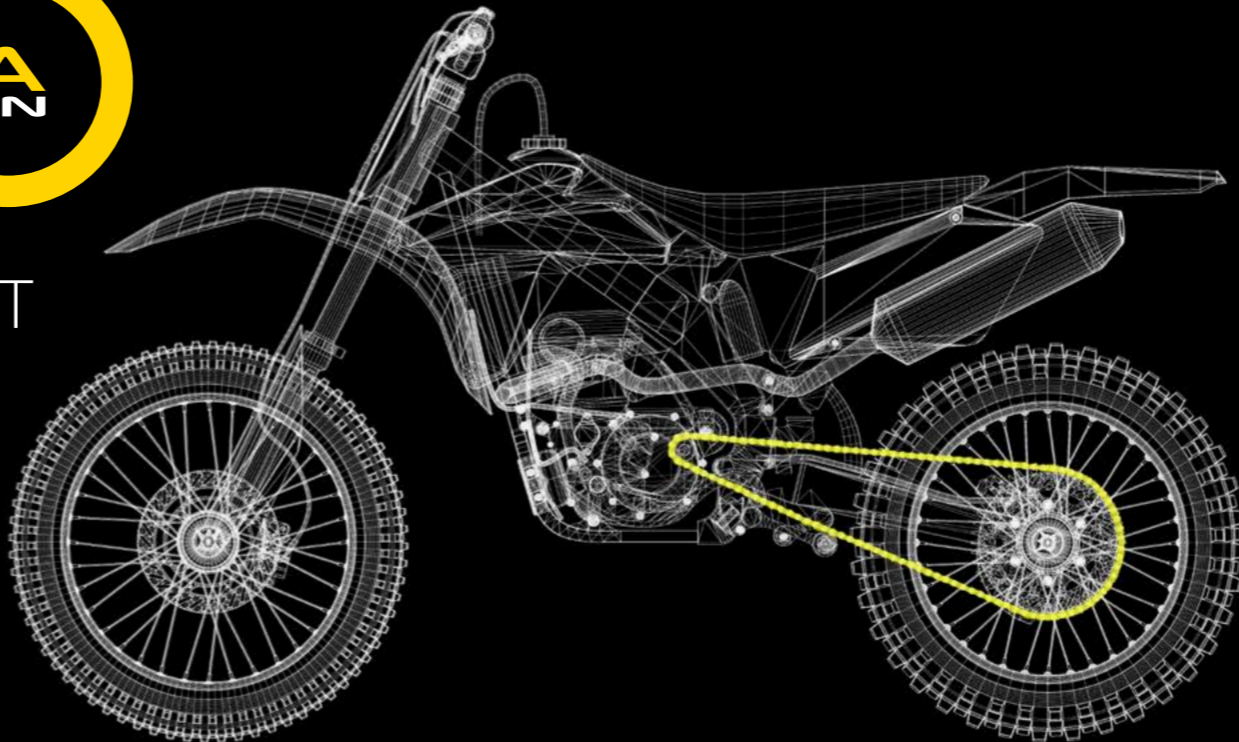
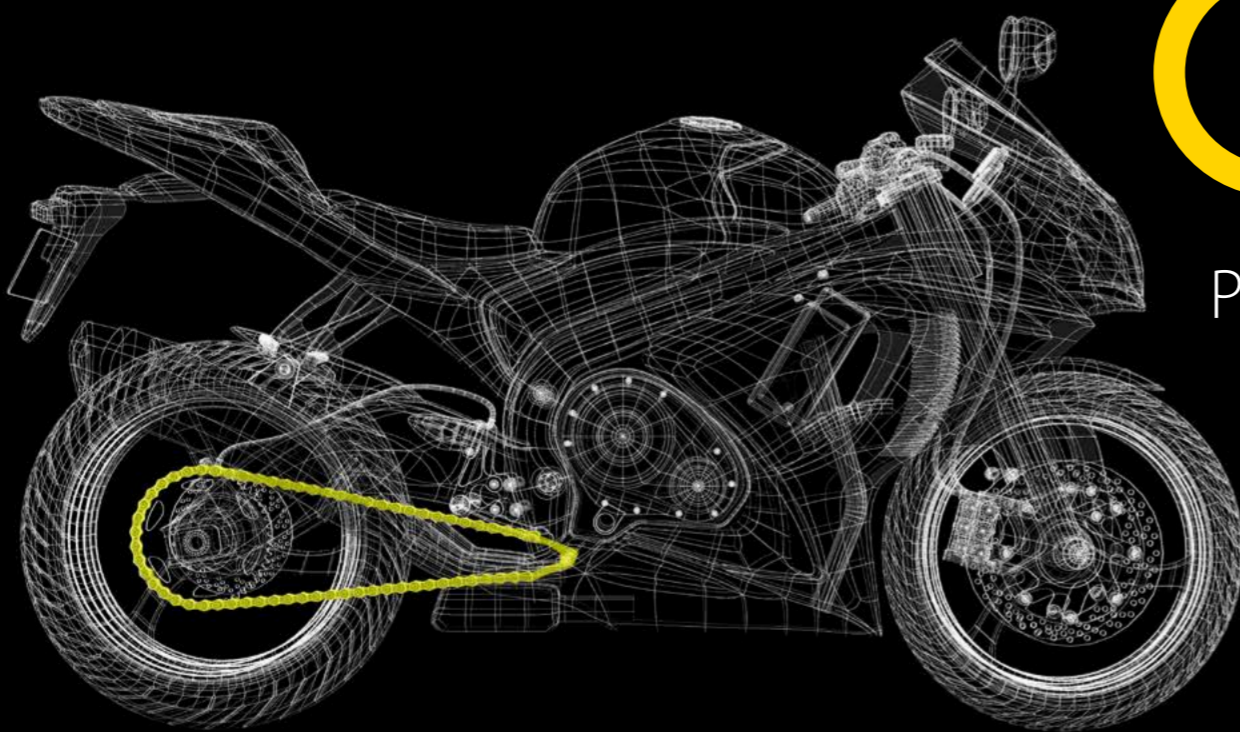

PROFESSIONAL Your chain. Any time.

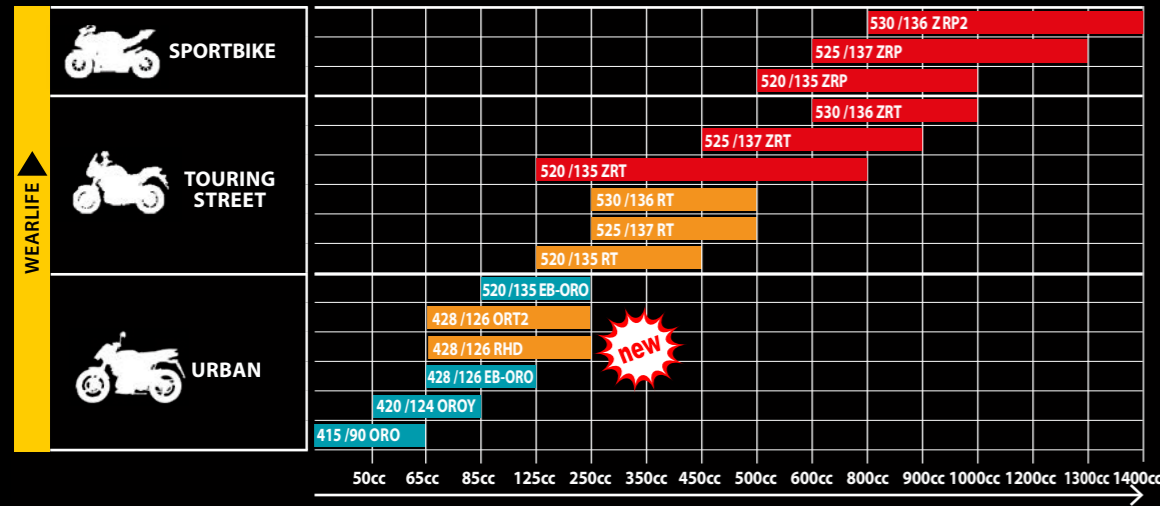

PROFESSIONAL Your chain. Any time.

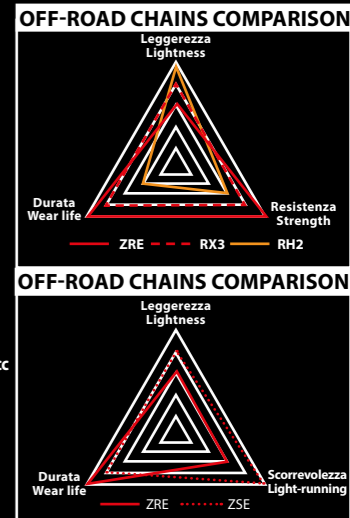
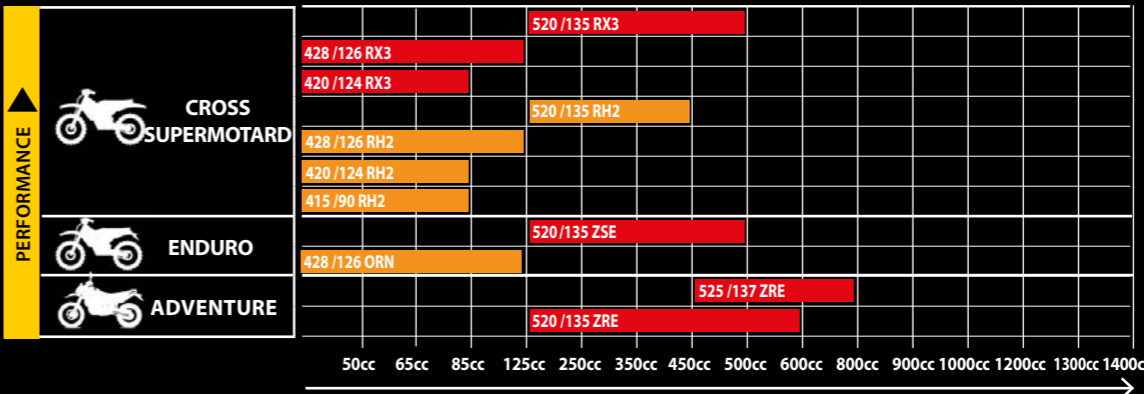

REGINA EXTRA The Chain of Champions.

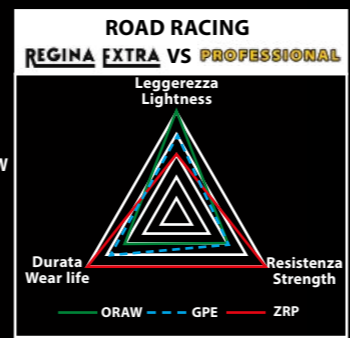
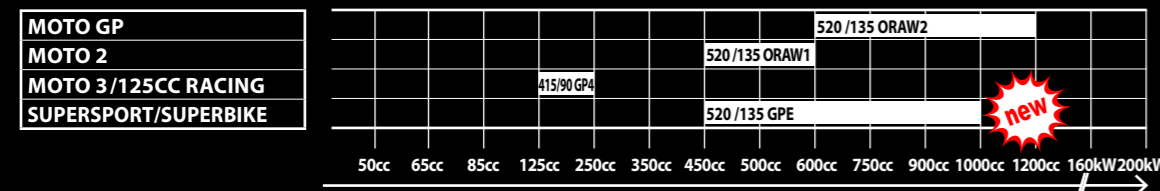

REGINA EXTRA The Chain of Champions.

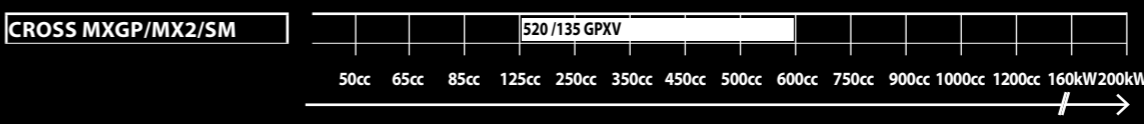

SPECIALTIES

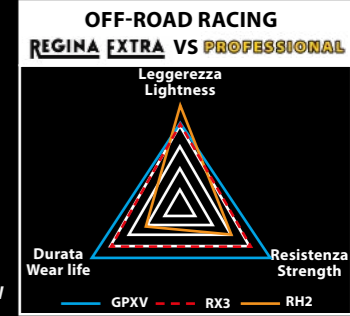

Black Dual

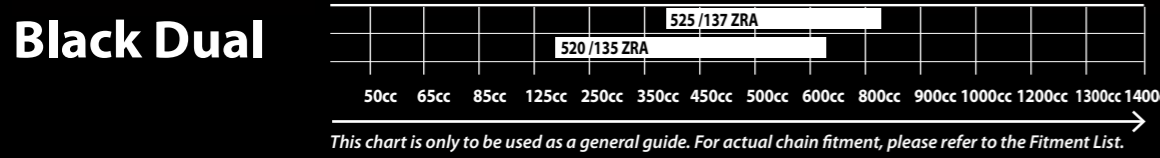

This chart is only to be used as a general guide. For actual chain fitment, please refer to the Fitment List.

Black Dual

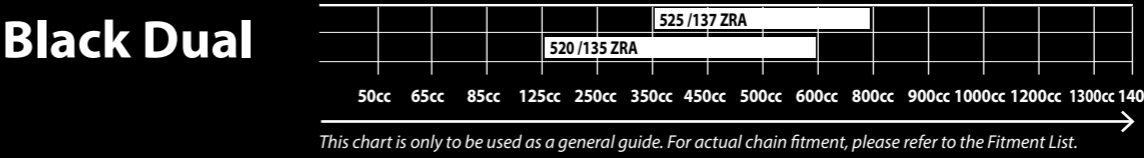

This chart is only to be used as a general guide. For actual chain fitment, please refer to the Fitment List.



Regina Classic
CHAIN
Once upon a time.

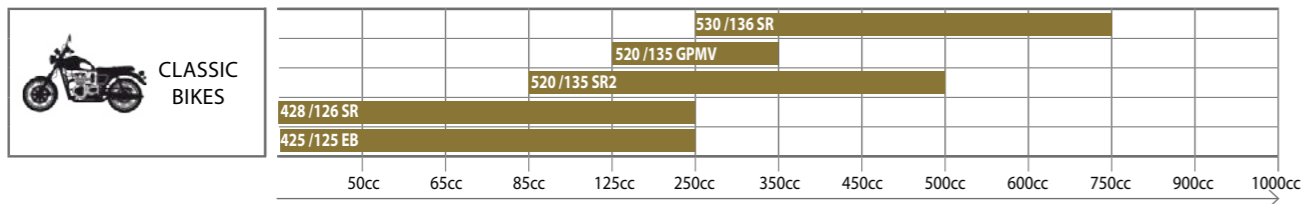

This chart is only to be used as a general guide. For actual chain fitment, please refer to the Fitment List.

TIMING

Invisible precision.

A wide range of bush / roller chains and inverted tooth chains for engine timing drives, available in various versions for motorcycle and automotive applications.

TOOLS

Maximize the Effectiveness.

A wide range of tools, including spare parts, to install and maintain your chains. All tools, designed and manufactured by Regina, were conceived to maximize the effectiveness and the safety of all operations.

Connecting links range

RIVET LINK TYPE 19

This is the rivet link traditionally proposed by Regina to close chains, used also in some motorcycle competition. It resists the mechanical stresses in the same way as the other links of the chain. Special tools are required to correctly install this link (see page 26).

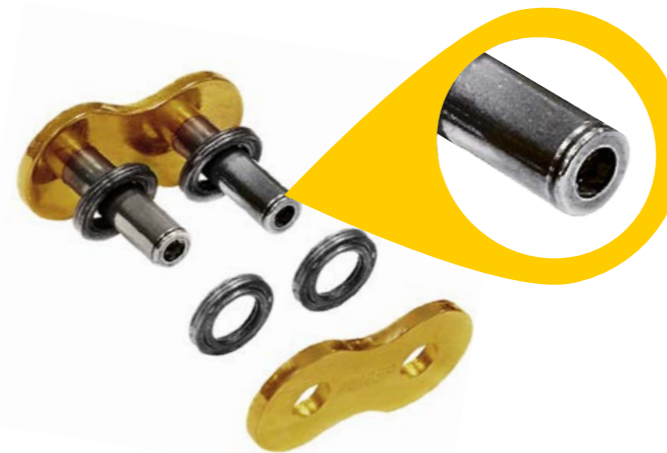

RIVET LINK TYPE 44

The rivet link type 44, which guarantees the same resistance as the link type 19, has special pins with holes that facilitate the pin head chamfering. A special tool is required to correctly install this link (see page 26).

SLIP FIT LINK TYPE 26

This connecting link is designed for installation on cross, enduro and supermotard bikes, as well as on mopeds. It is extremely easy to install and does not require dedicated tools. It should not be used on road motorcycles with more than 250 cc engine displacement and on off road motorcycles with more than 450 cc engine displacement.



PRESS FIT LINK TYPE 42

This connecting link is easy to install, requires a hammer for press fitting its external plate onto the pins, applying a second hammer on the back side, in contact with the pins' head (alternatively use a pliers with a straight plate on the back side in contact with the pins' head). It is designed mainly for installation on cross, enduro and supermotard bikes. It should not be used on motorcycles with more than 500 cc engine displacement.

Jack Miller



Photocredit: Alex Farnelli



Z-RING

Patented since 2003

The new generation Z-Ring seal, patented since 2003, featuring a special-designed conical shape on their inner side, represent the evolution of previous X-Ring and Z-Ring designs. The Z-Ring flexes when assembled, creating a spring effect that guarantees the seal will not decrease over time. The special Z-Ring section provides enhanced chain flexibility. The conical section enhances the assembling on the bushing. The lubricant trapped between the plates and the lobes of the Z-Ring keeps the ring lubricated and increases its life.



ZRP and ZRT are Original Equipments on:

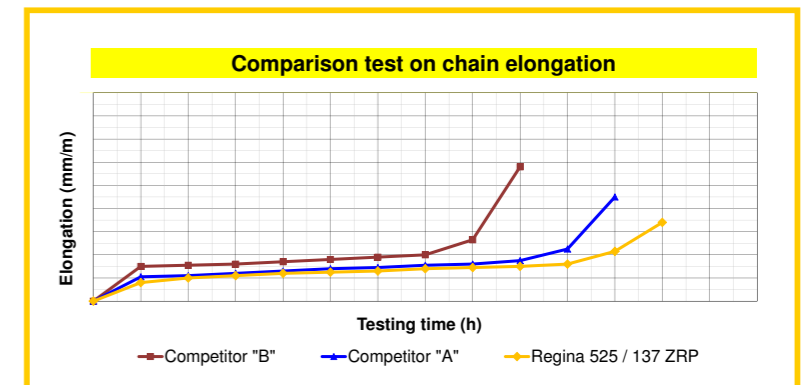
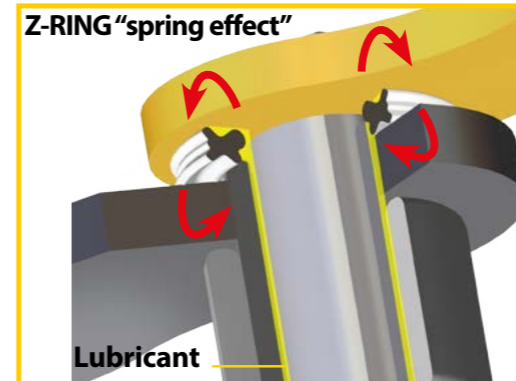

Alex Espargaró

PROFESSIONAL
Your chain. Any time.



Photocredit: Milagro

Sportbike

Specifically designed for application on high powered bikes, these chains are able to offer exceptional performance thanks to the patented Z-Ring. Assembled with high alloy steel pins and plates, solid bushings and rollers, shot-peening of plates, pins and rollers and pre-stressed for performance enhancement, assuring excellent resistance to mechanical stresses of the latest superbikes.

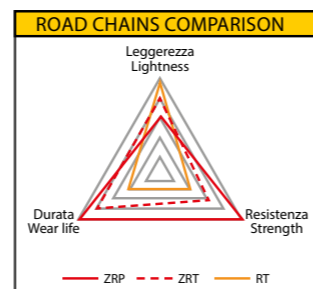

Touring Street

Intended for touring use, these chains ensure high mileage with reduced elongation thanks to the Z-Ring seal. Assembled with solid bushings and rollers, shotpeening of plates, pins and rollers to increase the fatigue resistance. Submitted to performance-enhancing pre-stretching, they are available in several quality levels to ensure the right type of chain for every application.

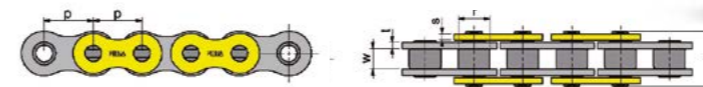

CHAIN	PITCH	INNER WIDTH		ROLLER Ø	PLATE THICKNESS		PIN LENGTH	WEIGHT			AVERAGE TENSILE STRENGTH		Seal	Color	Connecting link		
		mm	in.		mm	in.		kg/m	kg/100 links	Lbs/100 links	N	Lbs					
530	136 ZRP2*	15,875	5/8	9,53	3/8	10,23	2,6	2,4	25,4	1,43	2,27	5,01	42.000	9,442	ZR	G	19+44
525	137 ZRP	15,875	5/8	7,95	5/16	10,23	2,4	2,2	23,0	1,29	2,05	4,52	41.000	9,217	ZR	G	19+44
520	135 ZRP	15,875	5/8	6,35	1/4	10,23	2,2	2,2	21,3	1,11	1,76	3,89	36.000	8,093	ZR	G	19+44

G = Gold

* Connecting link NOT interchangeable with the 530/136 ZRP chain



CHAIN	PITCH	INNER WIDTH		ROLLER Ø	PLATE THICKNESS		PIN LENGTH	WEIGHT			AVERAGE TENSILE STRENGTH		Seal	Color	Connecting link		
		mm	in.		mm	in.		kg/m	kg/100 links	Lbs/100 links	N	Lbs					
530	136 RT	15,875	5/8	9,53	3/8	10,23	2,0	2,0	21,3	1,11	1,76	3,89	34.500	7,756	-	G	19+26
525	137 RT	15,875	5/8	7,95	5/16	10,23	2,0	2,0	19,5	1,03	1,63	3,61	34.000	7,643	-	G	19+26
520	135 RT	15,875	5/8	6,35	1/4	10,23	2,0	2,0	18,1	0,97	1,54	3,40	33.500	7,531	-	G	26

G = Gold



Aron Canet



Photocredit: GPRACINGPIX

Urban

Quality chains: performance, durability and style designed for urban vehicles. Special extended bushings, developed to increase the press-fit into the inner link plates of the chain, ensure a high resistance to chain kinking. All chains are pre-stretched to increase fatigue and made in gold color to increase wear resistance.

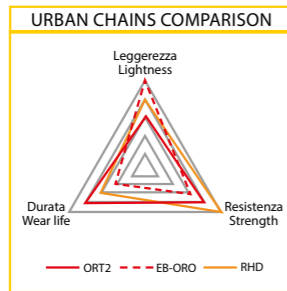
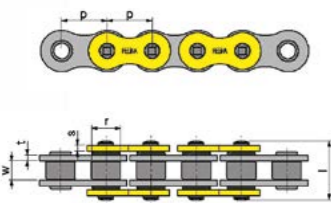

Chain Kit

Available for most of the popular motorcycles, Regina Chain Kits are the best choice to perfectly replace the secondary drive train of your bike. Each kit is provided with heat treated front sprocket, induction hardened rear sprocket and the right Regina chain for each motorcycle.

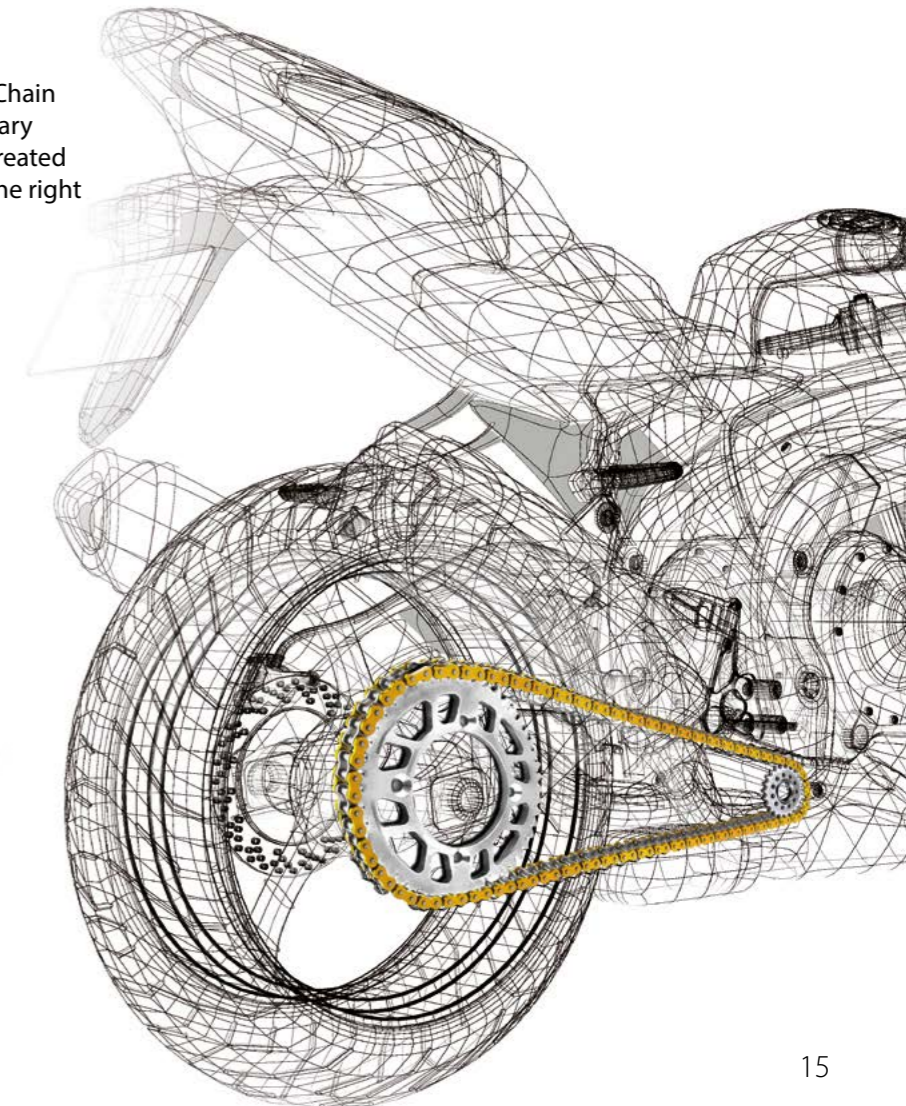

CHAIN	PITCH	INNER WIDTH	ROLLER Ø	PLATE THICKNESS	PIN LENGTH	WEIGHT			AVERAGE TENSILE STRENGTH		Seal	Color	Connecting link				
						kg/m	kg/100 links	Lbs/100 links	N	Lbs							
520	135 EB-ORO	15,875	5/8	6,35	1/4	10,16	1,8	1,8	17,3	0,86	1,37	3,01	28.500	6,407	-	G	26
428	126 ORT2	12,70	1/2	7,75	5/16	8,51	1,8	1,8	21,5	0,93	1,18	2,60	22.200	4,991	OR	G	26
428	126 RHD	12,70	1/2	7,75	5/16	8,51	2,0	1,8	19,0	0,84	1,06	2,35	23.500	4,722	-	G	26
428	126 EB-ORO	12,70	1/2	7,75	5/16	8,51	1,6	1,4	17,0	0,72	0,91	2,01	20.000	4,496	-	G	26
420	124 OROY	12,70	1/2	6,35	1/4	7,75	1,8	1,6	16,1	0,57	0,72	1,59	17.000	3,822	-	G	26
415	90 ORO	12,70	1/2	4,77	3/16	7,75	1,8	1,6	14,5	0,53	0,67	1,48	16.500	3,709	-	G	26

G = Gold



Tony Cairoli



RX3 chain is Original Equipment on:

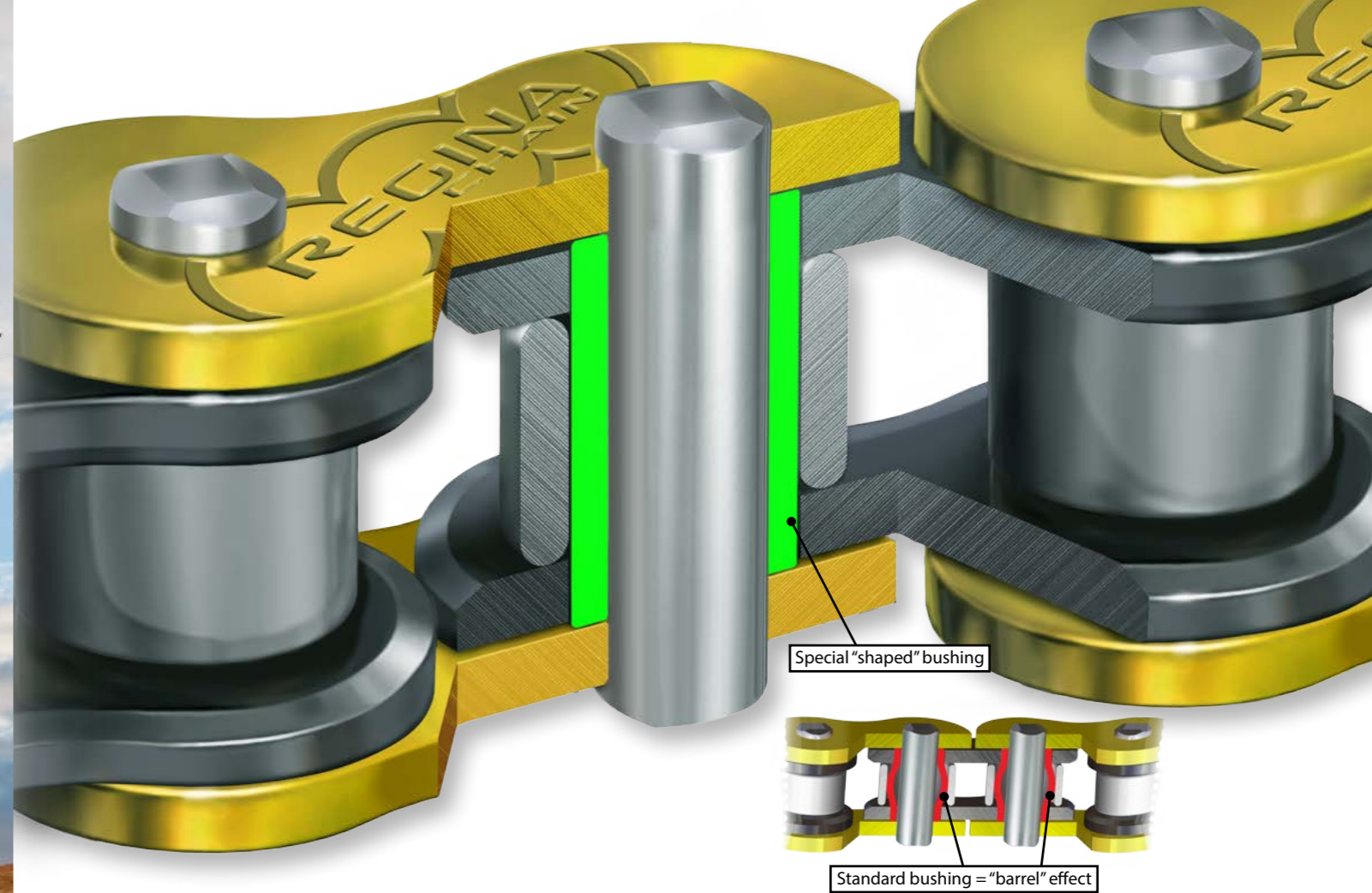

SHAPED BUSHING

Pioneer since 1985

RX3 chain features the special **Shaped Bushing** which eliminates the “barrel” effect that occurs when a standard bushing is assembled. The result is full contact between bushings and pins along the entire length, with a subsequent reduction in specific contact pressure and, hence, reduction wear.
RX3 chain features also **Chromized Pins**: exceptional pins surface hardness to maximize wear resistance and enhanced pin core strength to guarantee outstanding shock resistance.

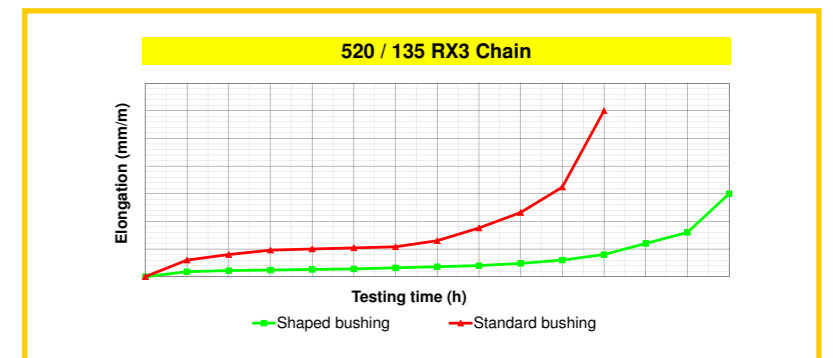
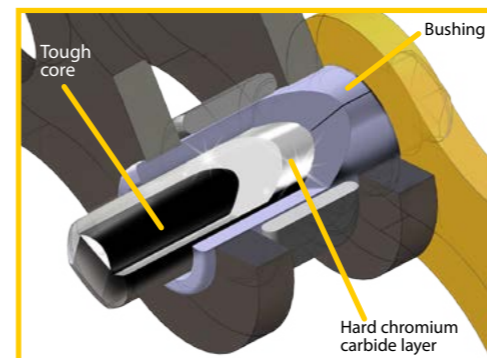

PROFESSIONAL

Your chain. Any time.

Jorge Prado



Danny Mc Canny



Cross Supermotard

Designed to ensure high resistance to elongation and to the severe impulsive stresses caused by Off-Road riding. Extended bushings and solid rollers, alloy carbon steel pins, shot-peened plates to offer increased tensile strength and fatigue resistance are some of the most important features. RX chains feature shaped bushings and special "X" chromized alloy carbon steel pins, together with special beveled plates to provide sure engagement in the most severe Off-Road applications.

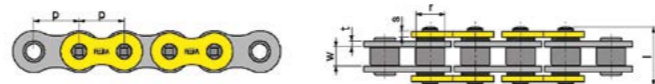

CHAIN	PITCH	INNER WIDTH		ROLLER Ø		PLATE THICKNESS		PIN LENGTH		WEIGHT			AVERAGE TENSILE STRENGTH		Seal	Color	Connecting link
		mm	in.	mm	in.	mm	mm	mm	mm	kg/m	kg/100 links	Lbs/100 links	N	Lbs			
520	135 RX3	15,875	5/8	6,35	1/4	10,16	2,0	2,0	18,1	0,98	1,56	3,43	34.000	7,643	-	G	26
428	126 RX3	12,70	1/2	7,75	5/16	8,51	1,8	1,8	18,5	0,79	1,00	2,21	23.000	5,170	-	G	26
420	124 RX3	12,70	1/2	6,35	1/4	7,75	1,6	1,6	16,3	0,65	0,82	1,82	21.000	4,721	-	G	26
520	135 RH2	15,875	5/8	6,35	1/4	10,23	2,0	2,0	18,1	0,97	1,54	3,40	33.400	7,508	-	G	26
428	126 RH2	12,70	1/2	7,75	5/16	8,51	2,0	1,8	18,9	0,79	1,00	2,21	22.500	5,058	-	G	26
420	124 RH2	12,70	1/2	6,35	1/4	7,75	1,6	1,6	16,3	0,65	0,82	1,82	20.000	4,496	-	G	26
415	90 RH2	12,70	1/2	4,77	3/16	7,75	1,6	1,6	14,7	0,60	0,76	1,68	19.500	4,384	-	G	26

G = Gold



Enduro

The new ZSE chains are the result of an intense development process made side by side with the best Enduro Racing Teams, with the aim to deliver the most efficient power transmission from engine to wheel, limiting friction while preserving durability. The result is the best light-running chain available on the market today. The new narrow Z-Ring, together with high carbon alloy steel shot-peened plates, offers a reliability proven by the fact many OEMs have chosen to fit ZSE chain as original equipment on their Enduro bike range. These features, added to light weight and narrow width, make ZSE the best choice in terms of performance for Enduro competitions.

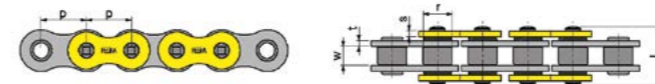

CHAIN	PITCH	INNER WIDTH		ROLLER Ø		PLATE THICKNESS		PIN LENGTH		WEIGHT			AVERAGE TENSILE STRENGTH		Seal	Color	Connecting link
		mm	in.	mm	in.	mm	mm	mm	mm	kg/m	kg/100 links	Lbs/100 links	N	Lbs			
520	135 ZSE	15,875	5/8	6,35	1/4	10,23	2,0	2,0	18,6	0,96	1,52	3,36	33.800	7,598	ZR	G	19+42+44
428	126 ORN	12,70	1/2	7,75	5/16	8,51	1,8	1,8	21,5	0,87	1,10	2,43	22.000	4,946	OR	G	26

G = Gold

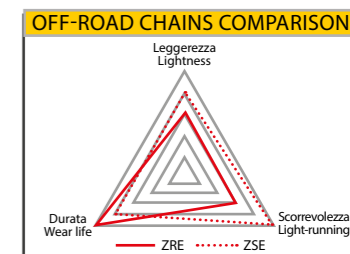



Taddy Blazusiak



Black Dual

BLACK DUAL chains have a natural steel color and are available in 520 and 525 dimensions only. Manufactured with high carbon alloy steel components, solid bushings and rollers, shot-peened plates, pins and rollers to reach high fatigue resistance. Laser marking on outer plates to identify dimension, model and origin.

Submitted to performance enhancing pre-stretching, also thanks to the Z-Ring seals, **BLACK DUAL** chains ensure high mileage, reduced elongation and extended lubrication intervals.



Adventure

Designed and developed to withstand the severe stresses caused by Off-Road riding, ZRE chains are intended for long distance Adventure use, thanks to the special Z-Ring which allows extended lubrication intervals while delivering incredible durability levels. ZRE chains are assembled with high carbon alloy steel, solid bushings and rollers, shot-peened plates, pins and rollers to reach high fatigue limits. ZRE is the chain you can trust, the best choice for Adventure riding.

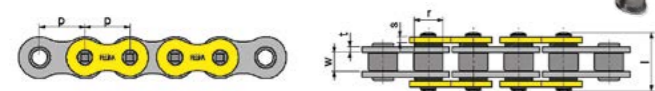
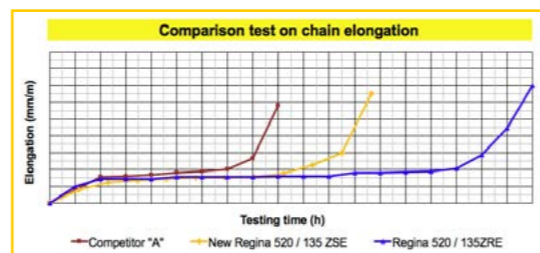

CHAIN	PITCH	INNER WIDTH		ROLLER Ø	PLATE THICKNESS	PIN LENGTH	WEIGHT			AVERAGE TENSILE STRENGTH		Seal	Color	Connecting link			
		mm	in.				kg/m	kg/100 links	Lbs/100 links	N	Lbs						
525	137 ZRE	15,875	5/8	7,95	5/16	10,23	2,2	2,2	23,0	1,23	1,95	4,31	36.000	8,093	ZR	G	19+44
520	135 ZRE	15,875	5/8	6,35	1/4	10,23	2,0	2,0	20,5	1,06	1,68	3,71	35.000	7,868	ZR	G	19+42+44

G = Gold

CHAIN	PITCH	INNER WIDTH		ROLLER Ø	PLATE THICKNESS	PIN LENGTH	WEIGHT			AVERAGE TENSILE STRENGTH		Seal	Color	Connecting link			
		mm	in.				kg/m	kg/100 links	Lbs/100 links	N	Lbs						
525	137ZRA	15,875	5/8	7,95	5/16	10,23	2,2	2,2	23,0	1,13	1,79	3,96	34.800	7823	ZR	B	19+44
520	135ZRA	15,875	5/8	6,35	1/4	10,23	2,0	2,0	20,5	1,00	1,59	3,50	33.800	7598	ZR	B	19+42+44

B = Black



REGINA EXTRA

The Chain of Champions.

Designed expressly for racing use, REGINA EXTRA series chains are the sum of Regina's experience collected in motorcycle competition. Available in several different models for every high performance application.



OFF ROAD RACING

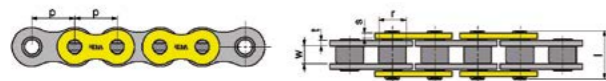
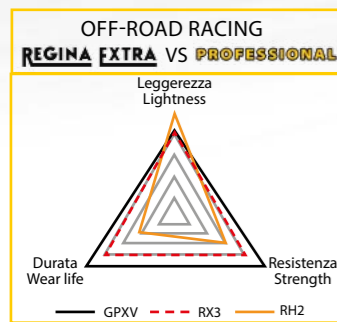

CHAIN		PITCH		INNER WIDTH		ROLLER Ø	PLATE THICKNESS	PIN LENGTH		WEIGHT			AVERAGE TENSILE STRENGTH		Seal	Color	Connecting link	
Application	International Reference	Regina Reference	mm	in.	mm	in.	mm	mm	mm	mm	kg/m	kg/100 links	Lbs/100 links	N	Lbs			
CROSS MXGP/MX2/SM	520	135 GPXV	15,875	5/8	6,35	1/4	10,16	2,0	2,0	18,1	0,98	1,56	3,43	35.000	7,868	-	G	19+26

G = Gold

ROAD RACING



CHAIN		PITCH		INNER WIDTH		ROLLER Ø	PLATE THICKNESS	PIN LENGTH		WEIGHT			AVERAGE TENSILE STRENGTH		Seal	Color	Connecting link	
Application	International Reference	Regina Reference	mm	in.	mm	in.	mm	mm	mm	mm	kg/m	kg/100 links	Lbs/100 links	N	Lbs			
MOTO GP	520	135 ORAW2	15,875	5/8	6,35	1/4	10,23	2,2	2,0	19,2	1,04	1,65	3,64	35.500	7,980	OR	B	19
MOTO2	520	135 ORAW1	15,875	5/8	6,35	1/4	10,23	2,0	2,0	18,6	1,00	1,59	3,50	35.000	7,868	OR	B	19
RACING 125CC MOTO3	415	90 GP4*	12,70	1/2	4,77	3/16	7,75	1,6	1,6	14,7	0,60	0,76	1,68	21.000	4,721	-	G	19+26
SUPERBIKE SUPERSPORT	520	135 GPE	15,875	5/8	6,35	1/4	9,23	2,2	2,0	20,7	1,07	1,70	3,75	36.000	8,093	ZR	G	19+44

* Connecting link interchangeable with the 415/90GP3 chain
B = Black G = Gold





Photocredit: Niklas Breu Photography

Paco Castagna

SPECIALTIES

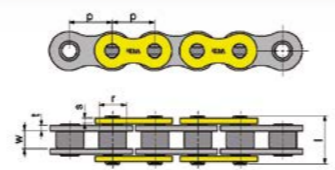

Application	CHAIN		PITCH		INNER WIDTH		ROLLER Ø	PLATE THICKNESS	PIN LENGTH	WEIGHT			AVERAGE TENSILE STRENGTH		Seal	Color	Connecting link	
	International Reference	Regina Reference	mm	in.	mm	in.	mm	mm	mm	kg/m	kg/100 links	Lbs/100 links	N	Lbs				
SPEEDWAY	520	135 EBSORO	15,875	5/8	6,35	1/4	10,16	1,8	1,8	17,3	0,89	1,41	3,12	29.000	6519	-	G	26
	428	126 SP5	12,70	1/2	7,75	5/16	8,51	2,0	1,8	18,9	0,83	1,05	2,32	21.500	4833	-	G	(19)*
ATV / QUAD	520	135 QUAD	15,875	5/8	6,35	1/4	10,23	2,2	2,2	21,3	1,11	1,76	3,89	36.500	8205	ZR	G	42
TRIAL	520	135 EBXL	15,875	5/8	6,35	1/4	10,16	1,6	1,6	16,6	0,80	1,27	2,80	27.000	6,070	-	B	26
KART	428	126 HK	12,70	1/2	7,75	5/16	8,51	2,0	1,8	18,9	0,83	1,05	2,32	23.500	5283	-	G	26
	A35	115 HK	9,525	3/8	4,77	3/16	5,08	1,6	1,5	13,9	0,42	0,40	0,88	11.500	2585	-	G	19
DRAG RACE	530	136 DR	15,875	5/8	9,53	3/8	10,23	2,4	2,6	23,0	1,37	2,17	4,80	47.000	10566	-	G	19+42
	520	135 DR	15,875	5/8	6,53	1/4	10,23	2,2	2,2	18,8	1,05	1,67	3,68	38.000	8542	-	G	19+42

*Endless connecting link if required

B = Black G = Gold



Regina Classic

CHAIN

Once upon a time.

In keeping with the history and tradition of Regina, we offer a range of original style natural coloured chains to suit Classic Motorcycles. The strength and integrity of this range is a

continuation of our dedication to quality and durability. Offset links are available for this range, in line with original chain fitment requirements.

CHAIN	PITCH	INNER WIDTH		ROLLER Ø	PLATE THICKNESS		PIN LENGTH	WEIGHT			AVERAGE TENSILE STRENGTH		Seal	Colors	Connecting link		
		mm	in.	mm	mm	mm	mm	kg/m	kg/100 links	Lbs/100 links	N	Lbs					
530	136 SR	15,875	5/8	9,53	3/8	10,16	1,6	1,5	19,0	0,88	1,40	3,08	22.800	5,125	-	B	26
520	135 GPMV	15,875	5/8	6,35	1/4	10,16	2,0	2,0	18,1	0,86	1,37	3,01	28.000	6,294	-	B	19+26
520	135 SR2	15,875	5/8	6,35	1/4	10,16	1,6	1,6	16,6	0,80	1,27	2,80	23.000	5,170	-	B	26
428	126 SR	12,70	1/2	7,75	5/16	8,51	1,6	1,4	16,4	0,71	0,90	1,98	18.500	4,159	-	B	26
425	125 EB	12,70	1/2	5,21	3/16	8,51	1,6	1,4	14,5	0,64	0,81	1,79	19.000	4,271	-	B	26

B = Black



TIMING

Invisible precision.



Bushing or roller chains for engine timing drives (cam drive, oil pump, water pump). Available in different types to fit motorcycle and automotive applications.

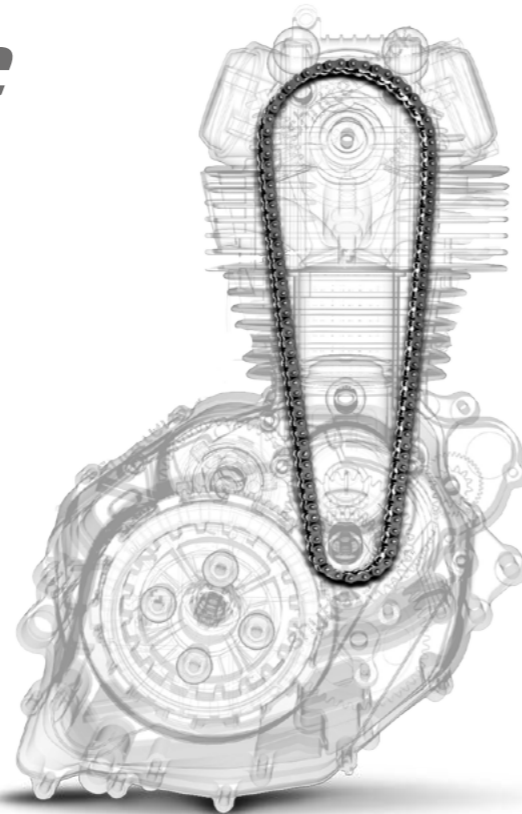
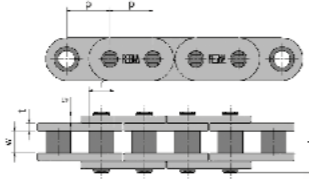

CHAIN	p		w		r	t	s	l	WEIGHT			AVERAGE TENSILE STRENGTH		Colors
	PITCH	INNER WIDTH	ROLLER Ø	PLATE THICKNESS	PIN LENGTH	kg/m	kg/100 links	Lbs/100 links	N	Lbs				
Regina Reference	mm	in.	mm	in.	mm	mm	mm	mm	kg/m	kg/100 links	Lbs/100 links	N	Lbs	Colors
C121 HCS	9,525	3/8	5,72	7/32	6,35	1,5	1,3	13,9	0,47	0,45	0,99	13.000	2,922	B
C221 CSSR	9,525	3/8	5,72	7/32	6,35	1,3	1,0	23,1	0,76	0,73	1,61	17.500	3,934	B
C226 T3	12,70	1/2	7,70	5/16	8,51	1,6	1,4	31,0	1,45	1,38	3,05	40.000	8,992	B
CA35-3S2N	9,525	3/8	4,77	3/16	5,08	1,3	1,3	32,7	1,15	1,10	2,42	35.000	7,868	B

B = Black



A range of patented inverted tooth chains for engine timing drives (cam drive, oil pump, water pump). Several types of chains, improved by the special "M" anti-wear pin treatment, are available to meet any requirement.

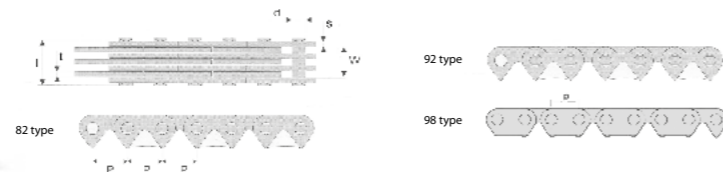

CHAIN	p		w		d	t	s	l	WEIGHT			AVERAGE TENSILE STRENGTH		Colors		
	PITCH	INNER WIDTH	N° PLATE	INT. WIDTH	PIN Ø	PLATE THICKNESS	PIN LENGTH	kg/m	kg/100 links	Lbs/100 links	N	Lbs				
Regina Reference	mm	in.	mm	in.	mm	mm	mm	mm	kg/m	kg/100 links	Lbs/100 links	N	Lbs	Colors		
82RH2005M	6,35	1/4	3,17	1/8	2X3	3,05	2,7	1,0	0,7	6,1	0,17	0,11	0,24	4.800	1,079	B
82RH2010M	6,35	1/4	6,35	1/4	3X4	5,10	2,7	1,0	0,7	8,2	0,25	0,16	0,35	6.850	1,540	B
82RH2015M	6,35	1/4	9,525	3/8	4X5	7,15	2,7	1,0	1,0	10,9	0,34	0,22	0,48	9.300	2,091	B
92RH2005M	6,35	1/4	3,17	1/8	2X3	3,05	2,4	1,0	0,7	6,1	0,17	0,11	0,24	5.100	1,146	B
92RH2010M	6,35	1/4	6,35	1/4	3X4	5,10	2,4	1,0	0,7	8,2	0,24	0,15	0,34	7.650	1,720	B
92RH2015M	6,35	1/4	9,525	3/8	4X5	7,15	2,4	1,0	0,7	10,3	0,32	0,20	0,44	10.200	2,293	B

The rivet links have flat shape (as 98 type).

B = Black

TOOLS

Maximize the Effectiveness.

CHAIN TOOLS

N.	DESCRIPTION	REGINA P/N
1	Chain breaker type 1 for 3/8"-1/2"-5/8"-3/4" chains	
2	Chain breaker type 7 for 3/8"-1/2"-5/8"-3/4" chains	805330
3	Pliers for O-Ring spring clip connecting link	805203
4	Professional tool for 1/2" chains assembling	805181
	Professional tool for 5/8" chains assembling	805187
	Professional tool for 3/4" chains assembling	805183
5	Professional tool for 1/2" chains riveting	805184
	Professional tool for 5/8" chains riveting	805185
	Professional tool for 3/4" chains riveting	805186
6	Cutting, assembling and riveting tool for 5/8" chains suitable for type19 & type44 connecting links	805199
7	Cutting, assembling and riveting tool for Silent chain	805191
8	Tools set for 5/8" chains: 805330 + 805187 + 805185	606015

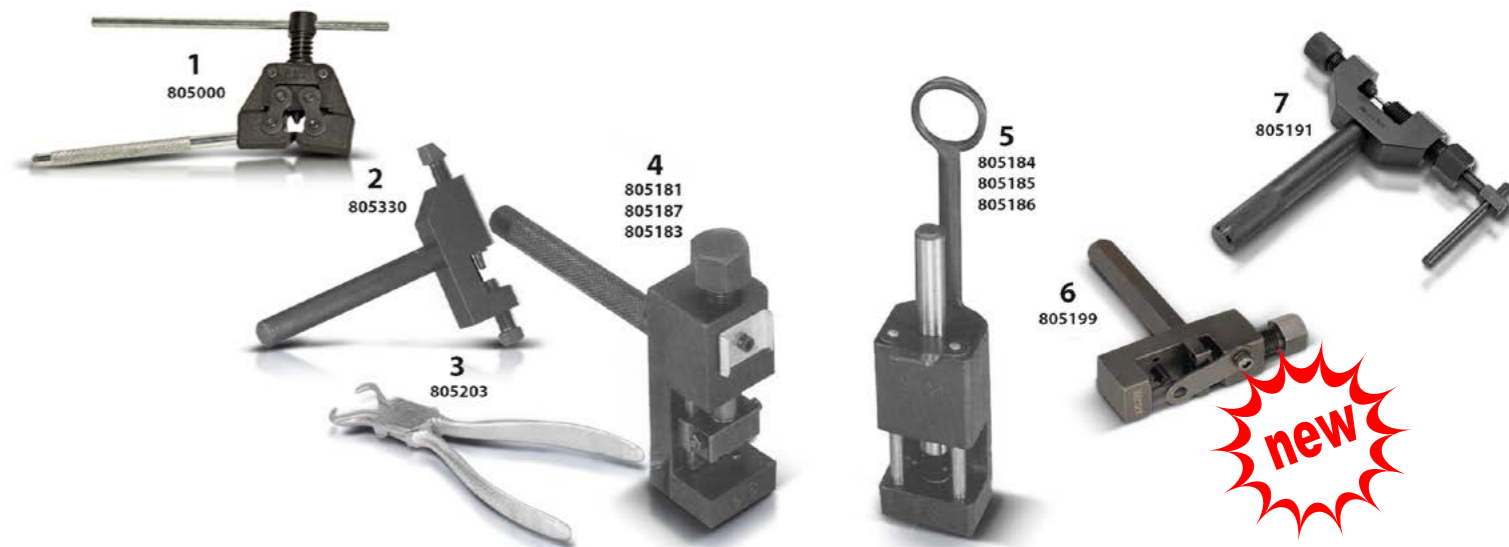

SPARE PARTS FOR TOOLS

Suitable for:	DESCRIPTION	REGINA P/N
805000	Pusher for chain breaker type 1	805001
805330	Pusher 5/8" and 3/4" for chain breaker type 7 - 8	805173
	Pusher 3/8" - 1/2" for chain breaker type 7	805174
805187	Link plate carrier for assembling tools 5/8" chain	805190
	Press fit link plate carrier for assembling tools 5/8" chains	805187/4B
	Holding blades for link plate carrier assembling tools (n.2 pieces)	805175B
805187 - 805185	Centering pin for 5/8" assembling and riveting tools	805176
805199	Link plate carrier for rivet link Type 44	805199/12
805184	Punch for 1/2" riveting tools	805178A
805185	Punch for 5/8" riveting tools	805178A
805186	Punch for 3/4" riveting tools	805178B
805191	Pusher for Silent chains breaker	805191/D





Carpet
200x80 cm
8ZP002



Banner TNT
5000X80 cm
8ZP005



Gloves
L
8ZA097
Pack 20 Pair

XL
8ZA098
Pack 20 Pair

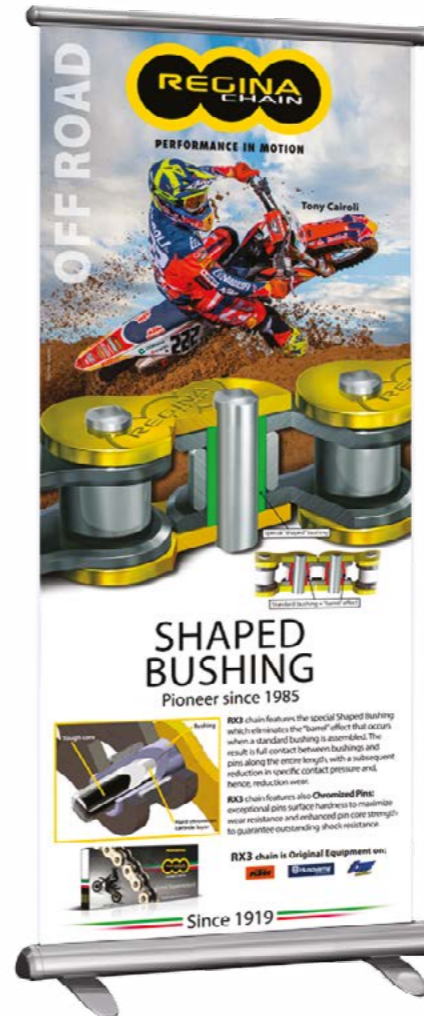

Roll up display OFF-ROAD SHAPED BUSHING
200x80 cm
I: 8ZP003
E: 8ZP006
DE: 8ZP007
ES: 8ZP008
FR: 8ZP009



Roll up display ROAD Z-RING
200x80 cm
I: 8ZP004
E: 8ZP010
DE: 8ZP011
ES: 8ZP012
FR: 8ZP013

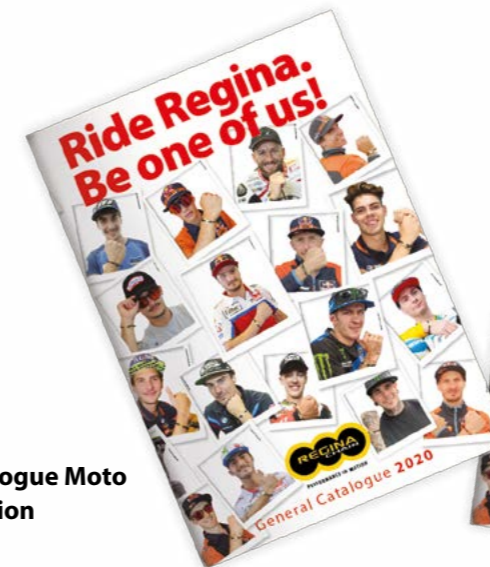

General Catalogue Moto Reduced version
21x29,7 cm
P.C13D20EC
Pack 25 PCS



General Catalogue Moto Complete version
21x29,7 cm
P.C13A20EC
Pack 10 PCS

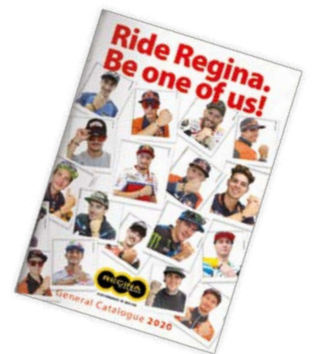

Leaflet Moto
10,5x14,8 cm
P.D20A20C
Pack 250 PCS



A global network

REGINA CHAIN is a world leading manufacturer of premium power transmission chains. We are focused on development and production since 1919, 100% made in Italy. We work in close partnership with the top international motorcycle manufacturers taking challenges at global level and achieving new goals every year. Evident result of our commitment are the World Championships we constantly conquer in the core racing categories at international level.



Window stickers
400x240 cm
8ZC260
Pack 25 PCS

Stickers
40 x18 cm
8ZC259
Pack 25 PCS

Stickers
11x4,7 cm
8ZC258
Pack 200 PCS

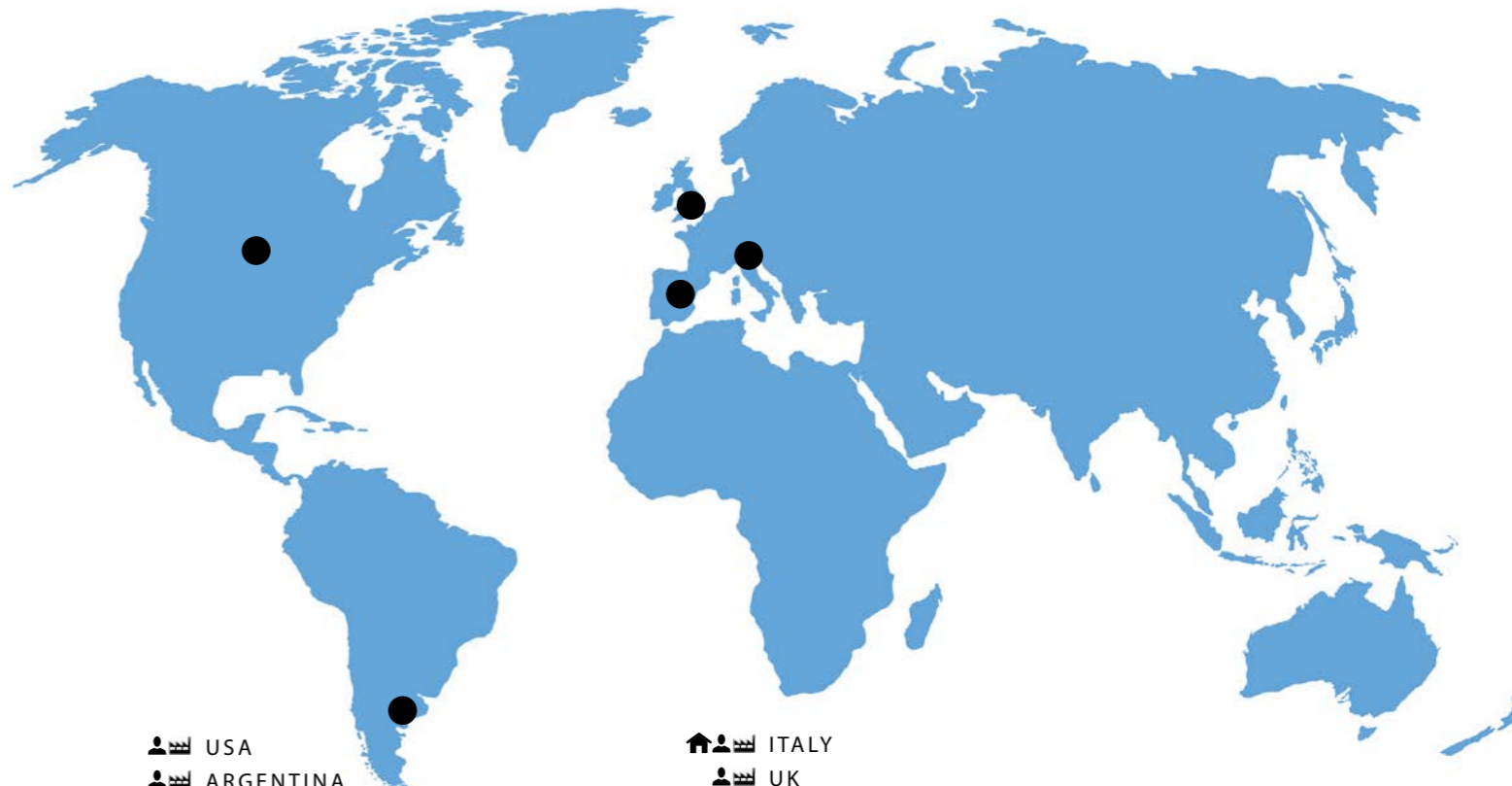

USA
ARGENTINA

ITALY
UK
SPAIN

HEADQUARTER SALES & SERVICE OFFICE WAREHOUSE/MANUFACTURING



REGINA CATENE CALIBRATE SPA: Via Monza 90 -23870 Cernusco Lombardone (LC) Italy
Tel. +39 039 99801 - Fax +39 039 9905229 - sales@reginachain.net