

**BORN  
TO BE  
MOTO**

2 0 2 1



**BORN  
TO BE  
MOTO**

**2 0 2 1**

CATALOGO - CATALOGUE

**PEDANE** REAR SETS

---

- A 16 regolabili - adjustable
- A 56 componenti ricambio - spare parts
- A 64 poggiapiedi - footpegs

**TENDITORI CATENA** CHAIN ADJUSTERS

---

- A 68 tenditori catena - chain adjusters
- B 72 supporti cavalletto - swing arm spools

**LEVE** LEVERS

---

- B 76 kit leve - levers kit
- B 79 leve freno / frizione - brake / clutch levers
- B 86 ricambi leve - levers spare parts

**BRACCIALI MANUBRIO** CLIP-ONS

---

- A 88 bracciali manubrio e tubi - clip-ons and handlebar tubes

**PROTEZIONI LEVE** LEVERS PROTECTIONS

---

- B 92 protezioni leve - levers protections

**ACCESSORI MANUBRIO** HANDLEBAR ACCESSORIES

---

- B 98 contrappesi manubrio - handle bar balancers

**SPECCHI** MIRRORS

---

- A 106 in alluminio - aluminium mirrors

**TAPPI SPECCHIO** MIRROR BLOCK-OFF PLATES

---

- B 110 tappi specchio colorati / coloured mirror block-off plates

**PORTA TARGA** LICENSE PLATE HOLDERS

---

- B 114 regolabili - adjustable

**LUCI** LIGHTS

---

- A 128 luci - lights

**PROTEZIONI IN ALLUMINIO** ALUMINIUM PROTECTIONS

---

- B 140 protezioni in alluminio - aluminium protections

**PROTEZIONI** PROTECTIONS

---

- B 146 protezioni telaio - frame sliders
- B 149 ricambi protezioni telaio - frame slider spare parts

## PROTEZIONI PERNI RUOTA WHEEL AXLE SLIDERS

- B 152 protezioni perni ruota - wheel axle sliders

## VITERIA BOLTS

- B 156 ergal 7075  
 C 158 titanio - titanium  
 B 160 special ergal 7075 - 7075 ergal special  
 B 162 forate - drilled  
 B 162 autofilettanti ergal 7075 - ergal7075 self tapping bolts  
 B 163 ganci rapidi e ricettacoli - quick fairing and receptacles  
 B 164 dadi e rondelle - nuts and washers  
 C 166 viti dischi freno in titanio - bolts for brake disk in titanium

## KIT VITI BOLTS KIT

- B 168 kit viti - bolts kit

## DADI SPECIAL SPECIAL NUTS

- B 172 dadi special - special nuts

## TAPPI CAPS

- A 176 tappi serbatoio - fuel tank caps  
 B 183 serbatoio olio freno e frizione - fluid tank for brake and clutch  
 B 184 tappi olio - oil filler caps  
 B 186 coperchi pompe freno e frizione - clutch/brake pump reservoir covers

## COMPONENTI IN CARBONIO CARBON PARTS

- C 192 componenti in carbonio - carbons parts

## CAVALLETTI STANDS RACING & BOX

- D 204 cavalletti - stands  
 A 210 accessori box - box accessories  
 A 212 serbatoio rifornimento rapido - fast fuel canister  
 B 213 saponette - knee sliders

## ADESIVI STICKERS

- B 216 adesivi / stickers

## COMMUNICAZIONE E MERCHANDISING COMMUNICATION AND MERCHANDISING

- 222 comunicazione e merchandising / communication and merchandising

|   |   |   |   |   |
|---|---|---|---|---|
| A | B | C | D | E |
|---|---|---|---|---|

# LIGHTTECH

## italianracingcomponents

Nel 1997, Fabrizio Furlan crea Lighttech per portare le competenze produttive della sua famiglia e della sua professione di pilota nell'eccitante mondo delle moto da corsa. Collaborare con prestigiosi team nel Campionato Mondiale Superbike, Moto GP, Moto 2GP e 125 GP ha permesso a Lighttech di sviluppare e diventare leader nel campo degli accessori per moto. Oggi, Lighttech si sviluppa su una superficie di 2.500 metri quadrati, così suddivisi: 1.400 dedicati alla produzione con sofisticati torni e frese a controllo numerico (CNC), 600 all'area magazzino e stoccaggio, 50 al dipartimento Ricerca e Sviluppo in cui gli ingegneri utilizzano programmi di disegno tecnico (CAD) e produzione (CAM) assistiti da computer per progettare. Oltre alla sede principale, Lighttech dispone di un altro stabilimento di 1.600 metri quadrati dotato di impianti per la produzione di pedane, leve freno-frizione e portatarga.

In 1997, Fabrizio Furlan created LighTech to bring his family's manufacturing expertise to the exciting world of motorcycle racing. Working closely with elite teams in the World Superbike Championship, Moto GP, 125 GP and Moto 2GP has allowed LighTech to become a leader of technologically advanced motorcycle performance parts and accessories. Today, the LighTech factory houses 2,500 square meters of which 1,400 dedicated to production with sophisticated computer-numeric-control (CNC) machines, 600 to storage area and 50 to research and development department where engineers use state-of-the-art computer-assisted design (CAD) and computer-assisted manufacturing (CAM) programs. In addition to the main factory, LighTech has a subsidiary with a 1,600 square meter facility for producing rearsets, brake and clutch levers and license plate holders.

### EFFICIENTAMENTO ENERGETICO DELL'IMPRESA LIGHTECH SRL

#### Descrizione degli interventi realizzati:

- Diagnosi energetica della struttura produttiva edificio-impianto;
- Installazione impianto solare fotovoltaico di potenza 123,69kWp;
- Relamping parziale con installazione di corpi illuminanti sostitutivi a LED;
- Installazione centro di lavoro CNC sostitutivo ad elevata efficienza energetica.

Intervento realizzato avvalendosi del finanziamento

POR - Obiettivo "Investimenti a favore della crescita e dell'occupazione"  
Parte FESR fondo europeo di sviluppo regionale 2014-2020

ASSE  
4  
AZIONE  
4.2.1



Un moltiplicatore di opportunità.  
Da non lasciarsi sfuggire.



BORN  
TO BE  
MOTO

[www.lightech.it](http://www.lightech.it)

 **LightTech**  
italian racing components



Il catalogo LighTech contiene più di 7.000 prodotti in Ergal che sono realizzati in diverse colorazioni, 400 prodotti in titanio ed una serie di numerosi altri accessori. LighTech può contare su di una rete vendita strutturata attualmente in oltre 1.500 rivenditori autorizzati in Italia e distributori in 50 altri paesi. Tale rete è in continuo ampliamento.

The scope of LighTech is enormous. The LighTech catalog contains over 7,000 ergal products that are manufactured in seven different colours, over 400 titanium products and a host of other accessories. LighTech has more than 1,500 authorized dealers in Italy and distributors in 50 countries.





# BORN TO BE MOTO

[www.lightech.it](http://www.lightech.it)

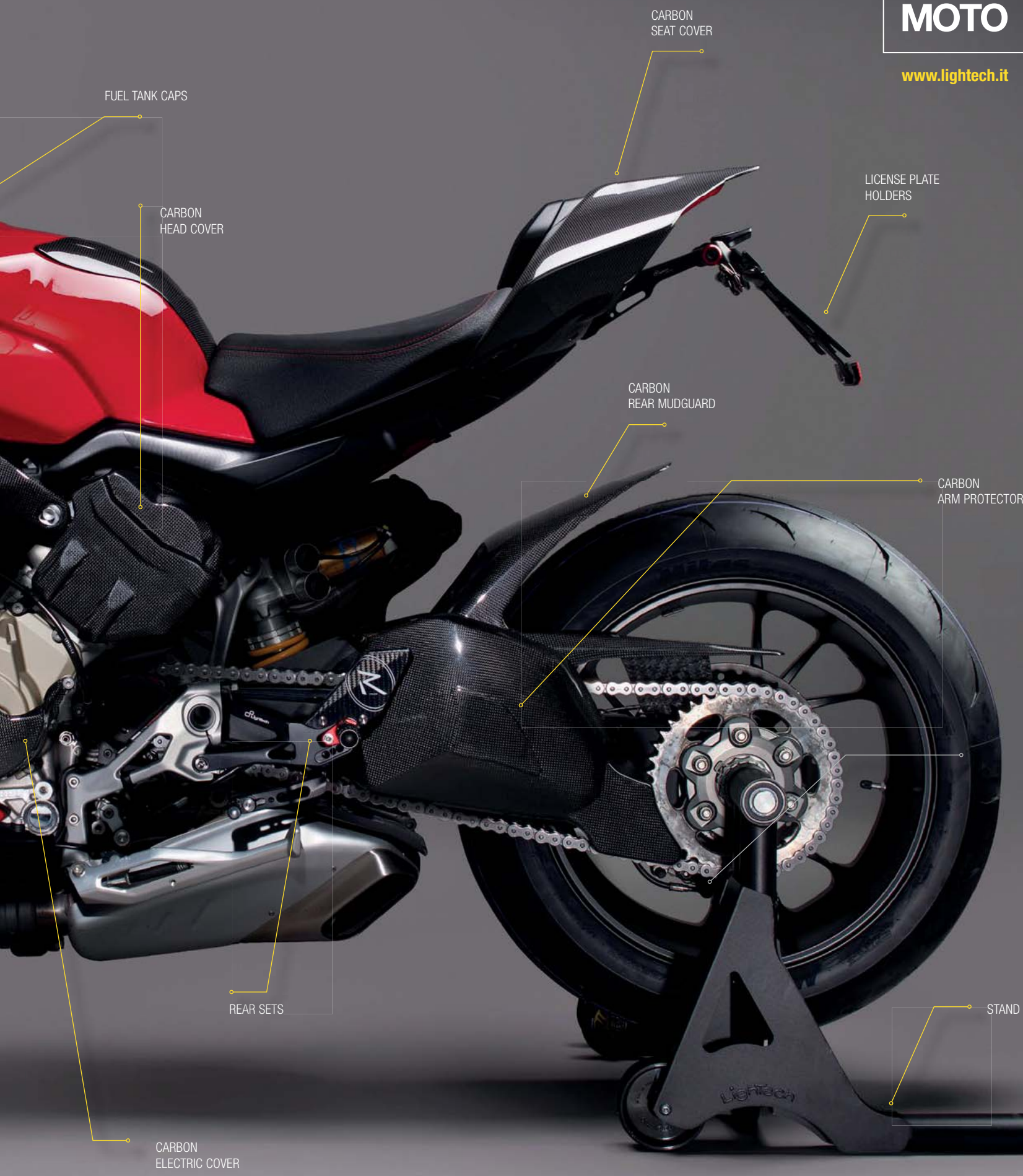

FUEL TANK CAPS

CARBON  
HEAD COVER

CARBON  
SEAT COVER

LICENSE PLATE  
HOLDERS

CARBON  
REAR MUDGUARD

CARBON  
ARM PROTECTOR

REAR SETS

CARBON  
ELECTRIC COVER

STAND

Lightech

Anni di sponsorizzazioni tecniche, l'utilizzo di un design e metodi di produzione all'avanguardia e la passione per la moto da corsa, sono le ragioni per cui si trovano qualità e innovazione in ogni prodotto Lightech.

Years of technical sponsorship, the use of cutting edge design and production methods and a passion for motorcycle racing are the reasons why you will find quality and innovation in every Lightech product. You can definitely believe that.

# SPEEDUP

*Racing*



## 2020 / 2021 · TECHNICAL SPONSOR



# UP

*ing Spirit*

**BORN  
TO BE  
MOTO**

[www.lightech.it](http://www.lightech.it)



# NEW COLLECTION

LIGHTECH 2021



#### TAGLIE DISPONIBILI / AVAILABLE SIZES

|             | Codice / Code |
|-------------|---------------|
| <b>XXS</b>  | TSH001        |
| <b>XS</b>   | TSH002        |
| <b>S</b>    | TSH003        |
| <b>M</b>    | TSH004        |
| <b>L</b>    | TSH005        |
| <b>XL</b>   | TSH006        |
| <b>XXL</b>  | TSH007        |
| <b>XXXL</b> | TSH008        |

T-Shirt

€ 30,00





TAGLIE DISPONIBILI / AVAILABLE SIZES

|             | Codice / Code |
|-------------|---------------|
| <b>XXS</b>  | HDS001        |
| <b>XS</b>   | HDS002        |
| <b>S</b>    | HDS003        |
| <b>M</b>    | HDS004        |
| <b>L</b>    | HDS005        |
| <b>XL</b>   | HDS006        |
| <b>XXL</b>  | HDS007        |
| <b>XXXL</b> | HDS008        |

Felpa con cappuccio / Hoodie

€ 60,00

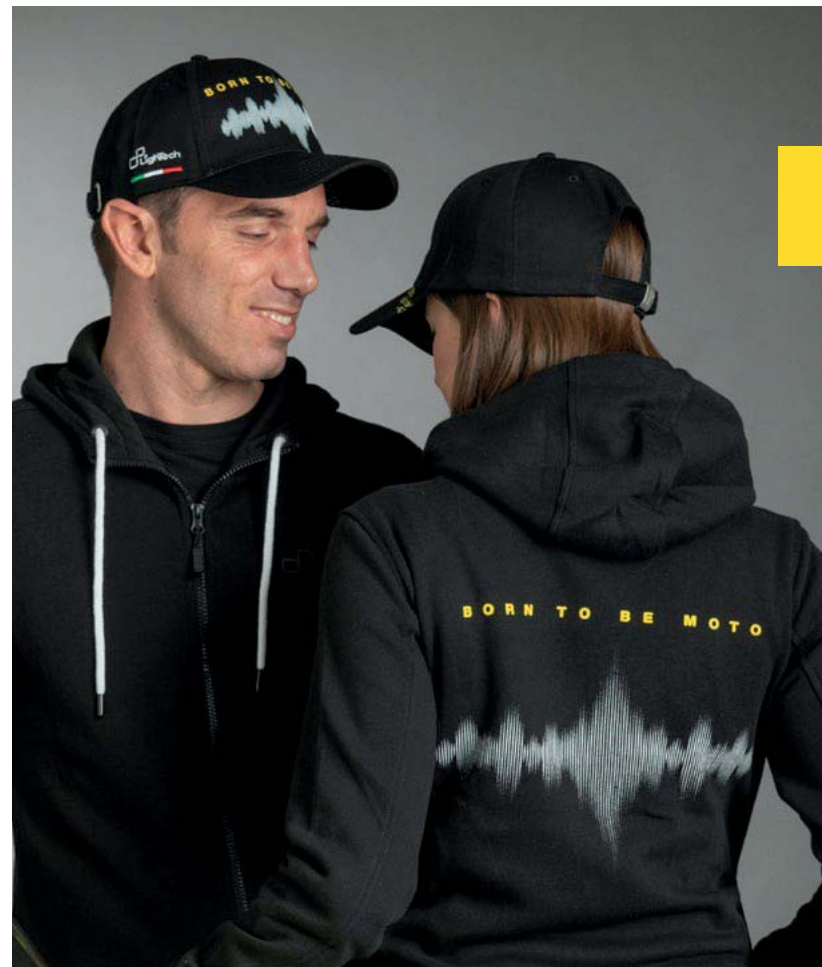
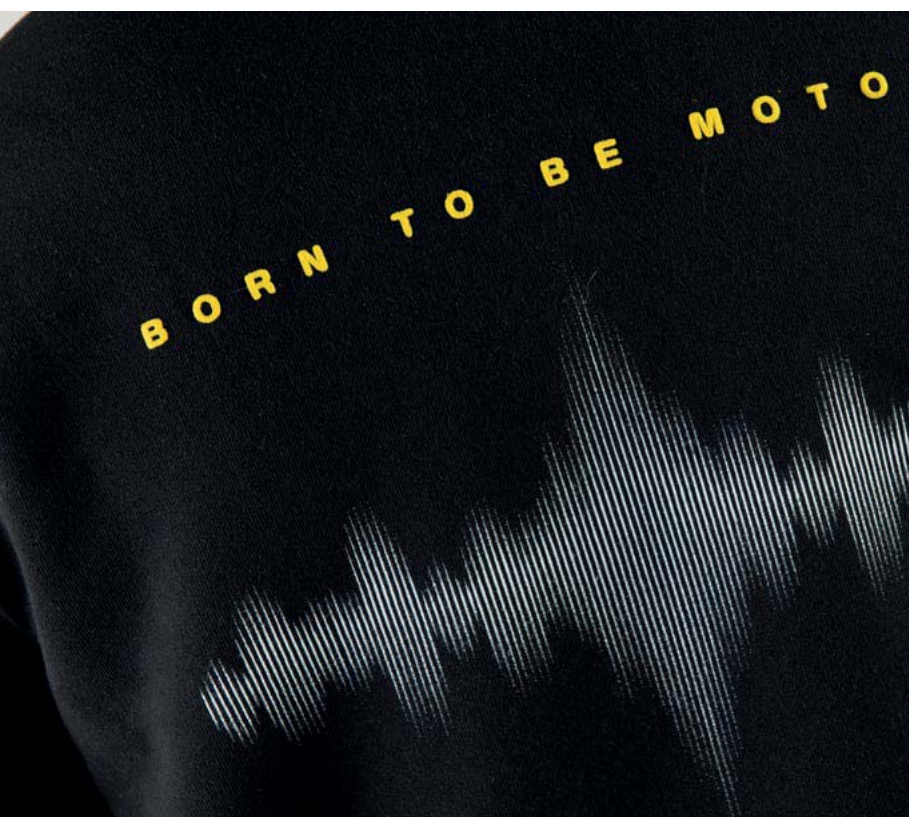

# HOODIE



Capellino da paddock / Paddock cap

BSC001

€ 28,00

BORN  
TO BE  
MOTO







**PEDANE**  
REAR SETS

**POGGIA PIEDE FISSO  
FIXED FOOTPEG**



silver  
silver

nero  
black

**POGGIA PIEDE SNODATO  
FOLDING FOOTPEG**



silver  
silver

cobalto  
cobalt

nero  
black

rosso  
red

oro  
gold

**SUPPORTO POGGIPIEDE  
FOOTPEG HOLDER**



Colori disponibili  
Available colours:



Supporto poggia piede lato freno  
Footpeg holder brake side



Supporto poggia piede lato cambio  
Footpeg holder shift side



Kit supporti poggia piedi "UP&DOWN"  
Supports kit for footpegs "UP&DOWN"



Supporto puntalino  
Toe peg holder

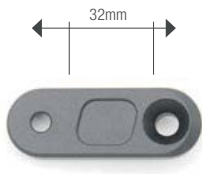

Supporto puntalino  
Toe peg holder

Tutte le pedane LighTech sono progettate e realizzate al **100%** nel nostro stabilimento.

All LighTech rear sets are designed and manufactured **100%** in our factory.



Uniball  
Mas M6 dx  
Mas M6 sx

VAR1036  
VAR1077



Uniball  
Fem M6 dx  
Fem M6 sx

VAR1095  
VAR1076



Paratacco in carbonio "White R"  
Carbon heel guard "White R"



Paratacco in alluminio  
Aluminium heel guard



Paratacco in carbonio  
Carbon heel guard



Paratacco in magnesio  
Magnesium heel guard



**TÜV homologated**

**FTR\_ \_ \_KBA90967**

**PUNTALINO SNODATO**  
**FOLDING FRONT TOE PEG**

rivestiti in gomma / rubber coated



Aluminium



Aluminium



Millerighe  
Gear shift arm



Millerighe  
Gear shift arm

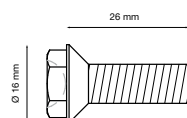

Vite per FTR507 / FTR508  
Bolt for FTR507 / FTR508



Vite per FTR507 / FTR508  
Bolt for FTR507 / FTR508

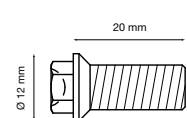

Vite per FTR704 / RFTR244  
Bolt for FTR704 / RFTR244



**RS 660**

TRACK SYSTEM

TÜV HOMOLOGATED

Anno / Year: 20-21

Cambio / Shifting: standard - reverse

|                                    |          |          |
|------------------------------------|----------|----------|
| Poggiapiede fisso<br>Fixed footpeg | FTRAP007 | € 560,00 |
|------------------------------------|----------|----------|

|  |           |          |
|--|-----------|----------|
| Poggiapiede snodato<br>Fold up footpeg | FTRAP007W | € 612,00 |
|--|-----------|----------|



**RS 660**

TRACK SYSTEM

TÜV HOMOLOGATED

Anno / Year: 20-21

Cambio / Shifting: standard - reverse

|             |           |          |
|-------------|-----------|----------|
| "R" version | FTRAP007R | € 773,00 |
|-------------|-----------|----------|

**RSV4 RF / RR / 1100 FACTORY**  
**TUONO V4 / 1100 FACTORY**

TÜV HOMOLOGATED

Anno / Year: 18-20

Cambio / Shifting: standard

|                                    |          |          |
|------------------------------------|----------|----------|
| Poggiapiede fisso<br>Fixed footpeg | FTRAP005 | € 400,00 |
|------------------------------------|----------|----------|

|  |           |          |
|--|-----------|----------|
| Poggiapiede snodato<br>Fold up footpeg | FTRAP005W | € 452,00 |
|--|-----------|----------|

Cambio / Shifting: reverse

|                                    |          |          |
|------------------------------------|----------|----------|
| Poggiapiede fisso<br>Fixed footpeg | FTRAP006 | € 415,00 |
|------------------------------------|----------|----------|

|  |           |          |
|--|-----------|----------|
| Poggiapiede snodato<br>Fold up footpeg | FTRAP006W | € 465,00 |
|--|-----------|----------|

**RSV4 RF / RR / 1100 FACTORY**  
**TUONO V4 / 1100 FACTORY**

TÜV HOMOLOGATED

Anno / Year: 18-20

Cambio / Shifting: standard

|             |           |          |
|-------------|-----------|----------|
| "R" version | FTRAP005R | € 614,00 |
|-------------|-----------|----------|

Cambio / Shifting: reverse

|             |           |          |
|-------------|-----------|----------|
| "R" version | FTRAP006R | € 625,00 |
|-------------|-----------|----------|



**RSV4  
TUONO V4**

TRACK  
SYSTEM

TÜV HOMOLOGATED

(tutte le versioni / all versions)

Anno / Year RSV4: 09-17  
Anno / Year TUONO V4: 11-17  
Cambio / Shifting: standard

PoggiapiEDE fisso  
Fixed footpeg FTRAP004 € 385,00

PoggiapiEDE snodato  
Fold up footpeg FTRAP004W € 437,00



**RSV4  
TUONO V4**

TRACK  
SYSTEM

TÜV HOMOLOGATED

(tutte le versioni / all versions)

Anno / Year RSV4: 09-17  
Anno / Year TUONO V4: 11-17  
Cambio / Shifting: standard

"R" version FTRAP004R € 598,00

KIT conversione cambio da standard a rovesciato per modello FTRAP004-W-R  
Conversion kit standard to reverse shift for p/n FTRAP004-W-R



RFTR236 € 125,00

**S1000RR**TRACK  
SYSTEM

TÜV HOMOLOGATED

Anno / Year: 19-21

Cambio / Shifting: standard - reverse

Poggiapiede fisso

Fixed footpeg

FTRBM007

€ 465,00

Poggiapiede snodato

Fold up footpeg

FTRBM007W

€ 515,00

**S1000RR**TRACK  
SYSTEM

TÜV HOMOLOGATED

Anno / Year: 19-21

Cambio / Shifting: standard - reverse

"R" version

FTRBM007R

€ 675,00

Supporto leva cambio per uso racing (senza cavalletto laterale)  
 Gear lever support for race use (without side stand)

Anno / Year: 19-21



FTR840NER

€ 46,00

## PEDANE REGOLABILI

22 ADJUSTABLE REAR SETS

KBA 90967

BMW



### S1000R S1000RR / HP4

TRACK  
SYSTEM

TÜV HOMOLOGATED

Anno / Year S1000R: 17-20  
Anno / Year S1000RR / HP4: 15-18  
Cambio / Shifting: standard - reverse

PoggiapiEDE fisso  
Fixed footpeg FTRBM004 € 437,00

PoggiapiEDE snodato  
Fold up footpeg FTRBM004W € 489,00



### S1000R S1000RR / HP4

TRACK  
SYSTEM

TÜV HOMOLOGATED

Anno / Year S1000R: 17-20  
Anno / Year S1000RR / HP4: 15-18  
Cambio / Shifting: standard - reverse

"R" version FTRBM004R € 650,00





**S1000R**  
**S1000RR / HP4**

TÜV HOMOLOGATED

Anno / Year S1000R: 14-16  
 Anno / Year S1000RR / HP4: 09-14  
 Cambio / Shifting: standard

PoggiapiEDE fisso  
 Fixed footpeg FTRBM001 € 414,00

PoggiapiEDE snodato  
 Fold up footpeg FTRBM001W € 466,00

**S1000R**  
**S1000RR / HP4**

TÜV HOMOLOGATED

Anno / Year S1000R: 14-16  
 Anno / Year S1000RR / HP4: 09-14  
 Cambio / Shifting: standard

"R" version FTRBM001R € 627,00

KIT conversione cambio da standard a rovesciato per modello FTRBM001-W-R  
 Conversion kit standard to reverse shift for p/n FTRBM001-W-R



RFTR164 € 172,00



**S1000R  
S1000RR / HP4**

TRACK  
SYSTEM

TÜV HOMOLOGATED

Anno / Year S1000R: 14-16  
Anno / Year S1000RR / HP4: 09-14  
Cambio / Shifting: reverse

PoggiapiEDE fisso  
Fixed footpeg FTRBM002 € 437,00

PoggiapiEDE snodato  
Fold up footpeg FTRBM002W € 489,00

BMW



**S1000R  
S1000RR / HP4**

TRACK  
SYSTEM

TÜV HOMOLOGATED

Anno / Year S1000R: 14-16  
Anno / Year S1000RR / HP4: 09-14  
Cambio / Shifting: reverse

"R" version FTRBM002R € 650,00

KIT conversione cambio da rovesciato a standard per modello FTRBM002-W-R  
Conversion kit reverse to standard shift for p/n FTRBM002-W-R



RFTR207 € 68,00



### R1200 GS

NOT TÜV HOMOLOGATED

Anno / Year: 13-18

Cambio / Shifting: standard

PoggiapiEDE snodato  
Fold up footpeg

FTRBM006NERW

€ 230,00

! FINE SERIE - END STOCK



Cambio / Shifting: standard

PoggiapiEDE snodato  
Fold up footpeg

FTRBM006COBW

€ 230,00

! FINE SERIE - END STOCK



Cambio / Shifting: standard

PoggiapiEDE snodato  
Fold up footpeg

FTRBM006ROSW

€ 230,00

! FINE SERIE - END STOCK

### FOR RACING USE ONLY

Non omologata TÜV  
No TÜV approved

BMW





**PANIGALE V4 / V4 S / V4 R / SPECIALE**



TÜV HOMOLOGATED

Anno / Year: 18-20

Cambio / Shifting: standard - reverse

Poggiapiede fisso  
Fixed footpeg FTRDU012 € 619,00

Poggiapiede snodato  
Fold up footpeg FTRDU012W € 671,00



**PANIGALE V4 / V4 S / V4 R / SPECIALE**



TÜV HOMOLOGATED

Anno / Year: 18-20

Cambio / Shifting: standard - reverse

"R" version FTRDU012R € 832,00

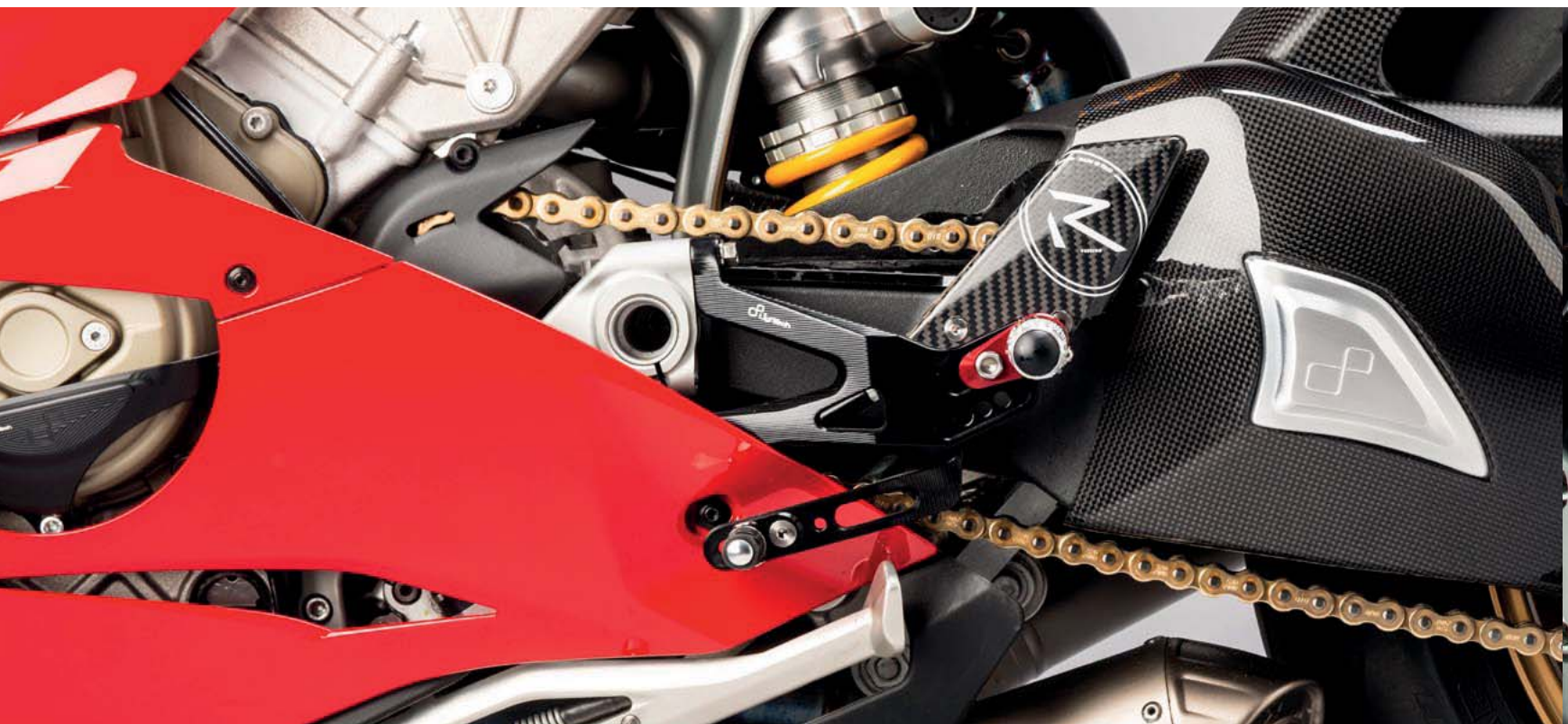



**STREETFIGHTER V4 / V4 S**

TRACK SYSTEM

TÜV HOMOLOGATED

Anno / Year: 20-20

Cambio / Shifting: standard - reverse

PoggiapiEDE fisso  
Fixed footpeg FTRDU012 € 619,00

PoggiapiEDE snodato  
Fold up footpeg FTRDU012W € 671,00

DUCATI



**STREETFIGHTER V4 / V4 S**

TRACK SYSTEM

TÜV HOMOLOGATED

Anno / Year: 20-20

Cambio / Shifting: standard - reverse

"R" version FTRDU012R € 832,00

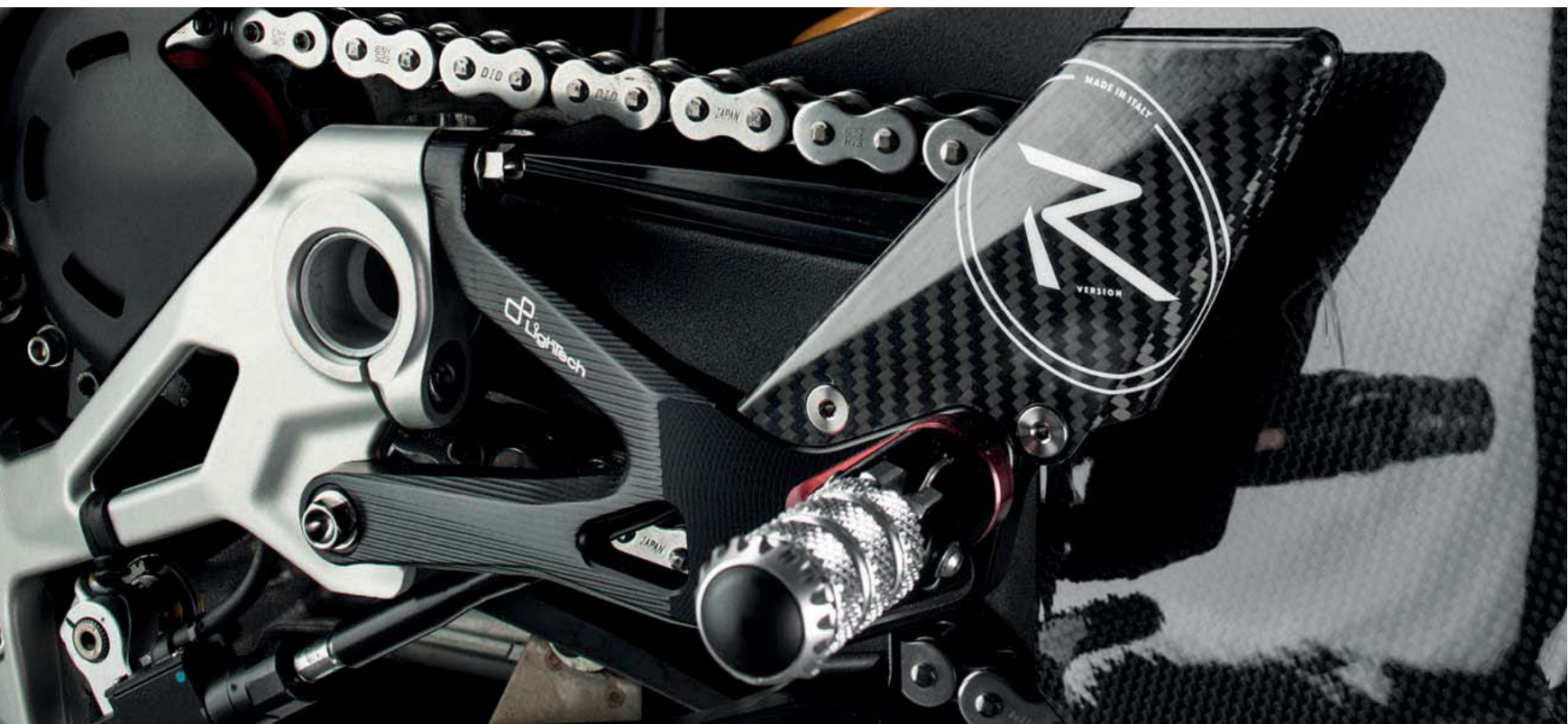



**PANIGALE 899 / 959 /  
1199 / 1299  
PANIGALE V2**

TRACK  
SYSTEM

TÜV HOMOLOGATED

Anno / Year PANIGALE 899 / 1199 / 1299: 12-17  
Anno / Year PANIGALE 959: 16-20  
Anno / Year PANIGALE V2: 20-20  
Cambio / Shifting: standard

Poggiapiede fisso  
Fixed footpeg FTRDU010 € 619,00

Poggiapiede snodato  
Fold up footpeg FTRDU010W € 671,00

Anno / Year PANIGALE 899 / 1199 / 1299: 12-17  
Anno / Year PANIGALE 959: 16-20  
Anno / Year PANIGALE V2: 20-20  
Cambio / Shifting: reverse

Poggiapiede fisso  
Fixed footpeg FTRDU011 € 619,00

Poggiapiede snodato  
Fold up footpeg FTRDU011W € 671,00

DUCATI



**PANIGALE 899 / 959 /  
1199 / 1299  
PANIGALE V2**

TRACK  
SYSTEM

TÜV HOMOLOGATED

Anno / Year PANIGALE 899 / 1199 / 1299: 12-17  
Anno / Year PANIGALE 959: 16-20  
Anno / Year PANIGALE V2: 20-20  
Cambio / Shifting: standard

"R" version FTRDU010R € 832,00

Anno / Year PANIGALE 899 / 1199 / 1299: 12-17  
Anno / Year PANIGALE 959: 16-20  
Anno / Year PANIGALE V2: 20-20  
Cambio / Shifting: reverse

"R" version FTRDU011R € 832,00

KIT conversione cambio da standard a rovesciato per mod. FTRDU010-W-R  
Conversion kit standard to reverse shift for p/n FTRDU010-W-R



RFTR192 € 62,50

KIT conversione cambio da rovesciato a standard per mod. FTRDU011-W-R  
Conversion kit reverse to standard shift for p/n FTRDU011-W-R



RFTR191 € 68,00

**CB1000R**

TÜV HOMOLOGATED

Anno / Year: 18-20

Cambio / Shifting: standard - reverse

 PoggiapiEDE fisso  
 Fixed footpeg

FTRH0008

€ 400,00

 PoggiapiEDE snodato  
 Fold up footpeg

FTRH0008W

€ 452,00

**CB1000R**

TÜV HOMOLOGATED

Anno / Year: 18-20

Cambio / Shifting: standard - reverse

"R" version

FTRH0008R

€ 614,00

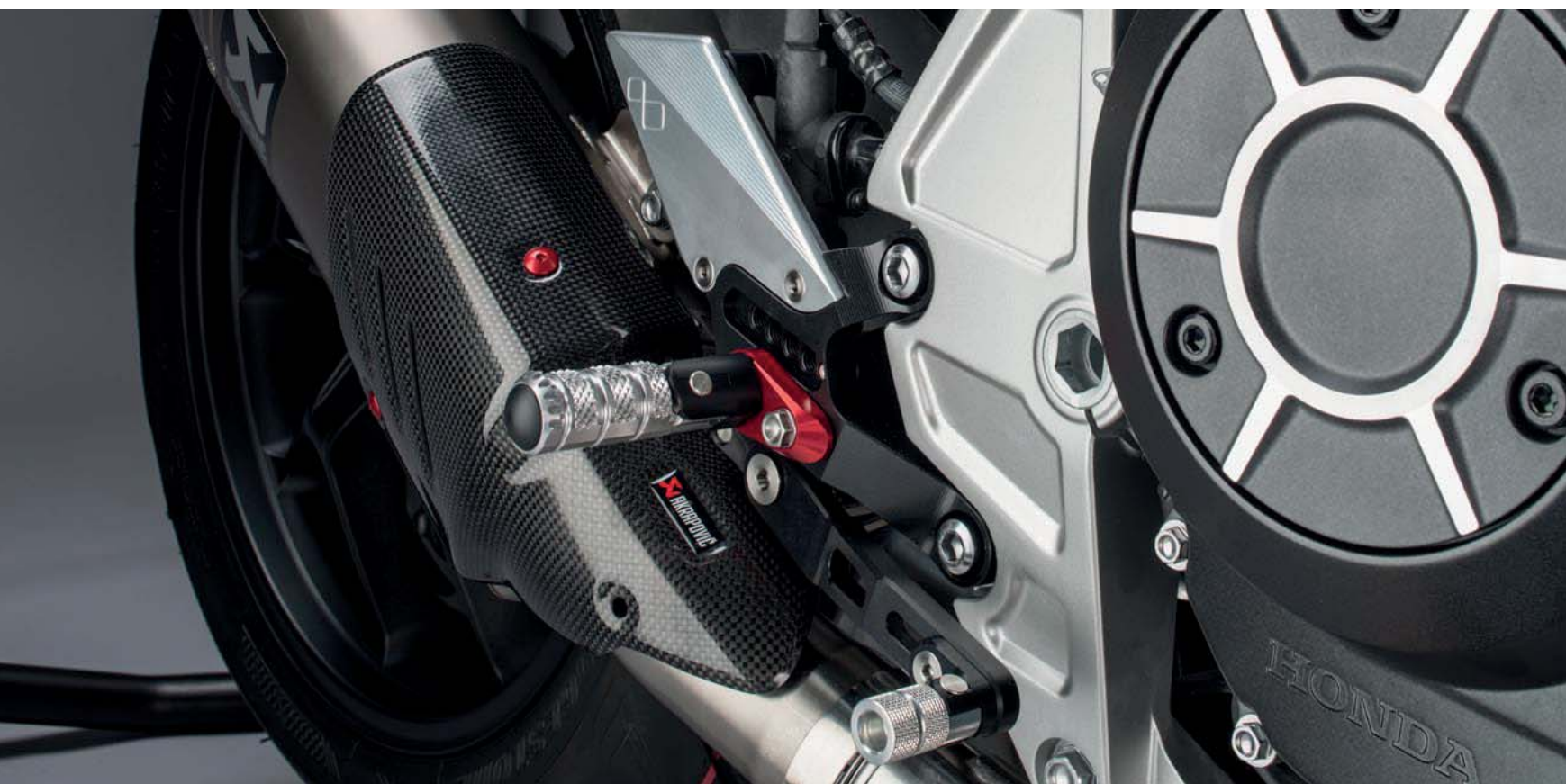



**CBR 600 RR**

TRACK SYSTEM

TÜV HOMOLOGATED

Anno / Year: 07-16

Cambio / Shifting: standard - reverse

Poggiapiede fisso

Fixed footpeg

FTRH0005

€ 400,00

Poggiapiede snodato

Fold up footpeg

FTRH0005W

€ 452,00

HONDA



**CBR 600 RR**

TRACK SYSTEM

TÜV HOMOLOGATED

Anno / Year: 07-16

Cambio / Shifting: standard - reverse

"R" version

FTRH0005R

€ 614,00



**CBR1000 RR-R / SP**

TÜV HOMOLOGATED

Anno / Year: 20-21

Cambio / Shifting: standard - reverse

 Poggiapiede fisso  
 Fixed footpeg

FTRH0011

€ 415,00

 Poggiapiede snodato  
 Fold up footpeg

FTRH0011W

€ 465,00

**CBR1000 RR-R / SP**

TÜV HOMOLOGATED

Anno / Year: 20-21

Cambio / Shifting: standard - reverse

"R" version

FTRH0011R

€ 625,00



Supporto leva cambio per uso racing (senza cavalletto laterale)  
 Gear lever support for race use (without side stand)  
 Anno / Year: 20-21

FTR883NER

€ 52,00



**CBR 1000 RR**

TRACK SYSTEM

TÜV HOMOLOGATED

Anno / Year: 08 19

Cambio / Shifting: standard - reverse

Poggiapiede fisso  
Fixed footpeg

FTRH0006 € 411,00

Poggiapiede snodato  
Fold up footpeg

FTRH0006W € 463,00

HONDA



**CBR 1000 RR**

TRACK SYSTEM

TÜV HOMOLOGATED

Anno / Year: 08 19

Cambio / Shifting: standard - reverse

"R" version

FTRH0006R € 623,00



**X-ADV**

NOT TÜV HOMOLOGATED

Anno / Year: 21-21

PoggiapiEDE snodato  
Fold up footpeg FTRH0012NER € 290,00



PoggiapiEDE snodato  
Fold up footpeg FTRH0012COB € 290,00



PoggiapiEDE snodato  
Fold up footpeg FTRH0012ROS € 290,00

**FOR RACING USE ONLY**

Non omologata TÜV  
No TÜV approved

HONDA



Max Bianconcini  
ph: Matteo Cannizzaro

## PEDANE REGOLABILI

34 ADJUSTABLE REAR SETS



### X-ADV

NOT TÜV HOMOLOGATED

Anno / Year: 17-20

Poggiapiede snodato  
Fold up footpeg

FTRH0009NER € 315,00



Poggiapiede snodato  
Fold up footpeg

FTRH0009COB € 315,00



Poggiapiede snodato  
Fold up footpeg

FTRH0009ROS € 315,00

### FOR RACING USE ONLY

Non omologata TÜV  
No TÜV approved

HONDA



**Z 900**

TRACK SYSTEM

TÜV HOMOLOGATED

Anno / Year: 17-21

Cambio / Shifting: standard - reverse

 Poggiapiede fisso  
 Fixed footpeg

FTRKA010 € 385,00

 Poggiapiede snodato  
 Fold up footpeg

FTRKA010W € 437,00

**Z 900**

TRACK SYSTEM

TÜV HOMOLOGATED

Anno / Year: 17-21

Cambio / Shifting: standard - reverse

"R" version

FTRKA010R € 598,00

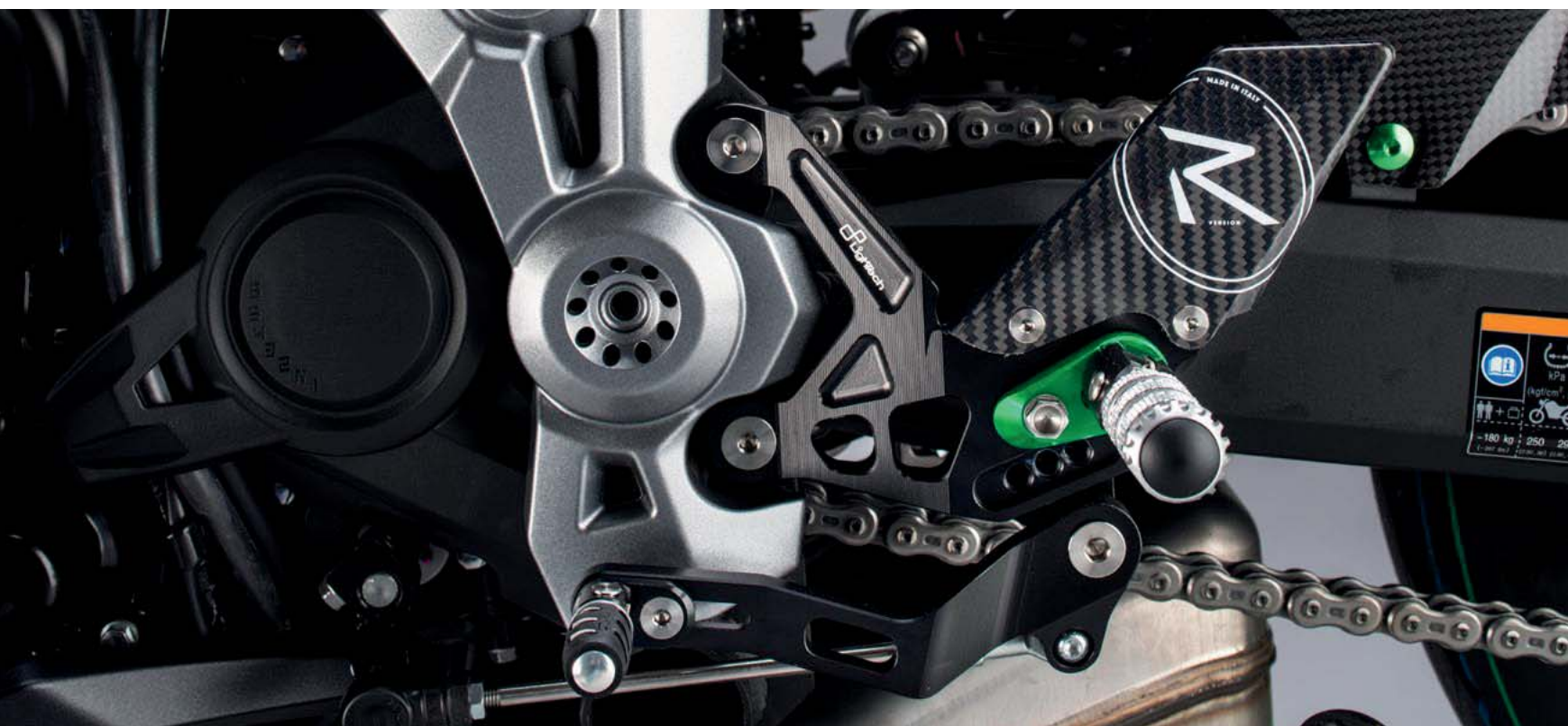

## PEDANE REGOLABILI

36 ADJUSTABLE REAR SETS

KBA 90967

KAWASAKI



### NINJA 400

TRACK SYSTEM

TÜV HOMOLOGATED

Anno / Year: 18-21

Cambio / Shifting: standard - reverse

Poggiapiède fisso  
Fixed footpeg

FTRKA007

€ 330,00

Poggiapiède snodato  
Fold up footpeg

FTRKA007W

€ 380,00



### NINJA 400

TRACK SYSTEM

TÜV HOMOLOGATED

Anno / Year: 18-21

Cambio / Shifting: standard - reverse

"R" version

FTRKA007R

€ 535,00



**ZX6R- 636**TRACK  
SYSTEM

TÜV HOMOLOGATED

Anno / Year: 05-21

Cambio / Shifting: standard

|                                    |          |          |
|------------------------------------|----------|----------|
| Poggiapiede fisso<br>Fixed footpeg | FTRKA008 | € 385,00 |
|------------------------------------|----------|----------|

|  |           |          |
|--|-----------|----------|
| Poggiapiede snodato<br>Fold up footpeg | FTRKA008W | € 437,00 |
|--|-----------|----------|

Cambio / Shifting: reverse

|                                    |          |          |
|------------------------------------|----------|----------|
| Poggiapiede fisso<br>Fixed footpeg | FTRKA009 | € 400,00 |
|------------------------------------|----------|----------|

|  |           |          |
|--|-----------|----------|
| Poggiapiede snodato<br>Fold up footpeg | FTRKA009W | € 452,00 |
|--|-----------|----------|

**ZX6R- 636**TRACK  
SYSTEM

TÜV HOMOLOGATED

Anno / Year: 05-21

Cambio / Shifting: standard

|             |           |          |
|-------------|-----------|----------|
| "R" version | FTRKA008R | € 598,00 |
|-------------|-----------|----------|

Cambio / Shifting: reverse

|             |           |          |
|-------------|-----------|----------|
| "R" version | FTRKA009R | € 614,00 |
|-------------|-----------|----------|



**ZX10R**

TRACK SYSTEM

TÜV HOMOLOGATED

Anno / Year: 16-20

Cambio / Shifting: standard

Poggiapiede fisso  
Fixed footpeg

FTRKA006

€ 400,00

Poggiapiede snodato  
Fold up footpeg

FTRKA006W

€ 452,00

KAWASAKI



**ZX10R**

TRACK SYSTEM

TÜV HOMOLOGATED

Anno / Year: 16-20

Cambio / Shifting: standard

"R" version

FTRKA006R

€ 614,00

KIT conversione cambio da standard a rovesciato per modello FTRKA006-W-R  
Conversion kit standard to reverse shift for p/n FTRKA006-W-R  
Anno / Year: 16-20



RFTR232

€ 125,00



**ZX10R**TRACK  
SYSTEM

TÜV HOMOLOGATED

Anno / Year: 11-15

Cambio / Shifting: standard - reverse

Poggiapiede fisso

Fixed footpeg

FTRKA003

€ 385,00

Poggiapiede snodato

Fold up footpeg

FTRKA003W

€ 437,00

**ZX10R**TRACK  
SYSTEM

TÜV HOMOLOGATED

Anno / Year: 11-15

Cambio / Shifting: standard - reverse

"R" version

FTRKA003R

€ 598,00



**DUKE 790  
DUKE 890**

TRACK  
SYSTEM

TÜV HOMOLOGATED

Anno / Year DUKE 790: 18-21  
Anno / Year DUKE 890: 20-21  
Cambio / Shifting: standard - reverse

Poggiapiede fisso  
Fixed footpeg FTRKT002 € 411,00

Poggiapiede snodato  
Fold up footpeg FTRKT002W € 463,00



**DUKE 790  
DUKE 890**

TRACK  
SYSTEM

TÜV HOMOLOGATED

Anno / Year DUKE 790: 18-21  
Anno / Year DUKE 890: 20-21  
Cambio / Shifting: standard - reverse

"R" version FTRKT002R € 623,00



**RC 125 /  
RC 200 / RC 390**

TRACK  
SYSTEM

NOT TÜV HOMOLOGATED

Anno / Year: 17-20

Cambio / Shifting: standard - reverse

PoggiapiEDE fisso  
Fixed footpeg FTRKT001 € 590,00

PoggiapiEDE snodato  
Fold up footpeg FTRKT001W € 642,00

**FOR RACING USE ONLY**

Non omologata TÜV  
No TÜV approved

KTM





**F3 675**

**F3 800**

TRACK SYSTEM

TÜV HOMOLOGATED

Anno / Year F3 675: 11-16  
 Anno / Year F3 800: 13-16  
 Cambio / Shifting: standard - reverse

Poggiapiede fisso  
 Fixed footpeg **FTRMV002** € 411,00

! FINE SERIE - END STOCK

Poggiapiede snodato  
 Fold up footpeg **FTRMV002W** € 463,00

Not compatible with EURO4 models ! FINE SERIE - END STOCK



**F3 675**

**F3 800**

TRACK SYSTEM

TÜV HOMOLOGATED

Anno / Year F3 675: 11-16  
 Anno / Year F3 800: 13-16  
 Cambio / Shifting: standard - reverse

"R" version **FTRMV002R** € 623,00

Not compatible with EURO4 models ! FINE SERIE - END STOCK

**GSX-R 600**  
**GSX-R 750**

TÜV HOMOLOGATED

Anno / Year: 11-17

Cambio / Shifting: standard - reverse

|                                    |          |          |
|------------------------------------|----------|----------|
| Poggiapiede fisso<br>Fixed footpeg | FTRSU002 | € 385,00 |
|------------------------------------|----------|----------|

|  |           |          |
|--|-----------|----------|
| Poggiapiede snodato<br>Fold up footpeg | FTRSU002W | € 437,00 |
|--|-----------|----------|

**GSX-R 600**  
**GSX-R 750**

TÜV HOMOLOGATED

Anno / Year: 11-17

Cambio / Shifting: standard - reverse

|             |           |          |
|-------------|-----------|----------|
| "R" version | FTRSU002R | € 598,00 |
|-------------|-----------|----------|

 Fabio Di Giannantonio  
 Team SpeedUp

## PEDANE REGOLABILI

44 ADJUSTABLE REAR SETS

KBA 90967

SUZUKI



### GSX-R 1000 GSX-R 1000 R

TRACK  
SYSTEM

TÜV HOMOLOGATED

Anno / Year: 17-21

Cambio / Shifting: standard - reverse

Poggiapiede fisso  
Fixed footpeg FTRSU004 € 411,00

Poggiapiede snodato  
Fold up footpeg FTRSU004W € 463,00



### GSX-R 1000 GSX-R 1000 R

TRACK  
SYSTEM

TÜV HOMOLOGATED

Anno / Year: 17-21

Cambio / Shifting: standard - reverse

"R" version FTRSU004R € 623,00



**GSX-S 1000**

TRACK SYSTEM

TÜV HOMOLOGATED

Anno / Year: 15-20

Cambio / Shifting: standard - reverse

Poggiapiede fisso  
Fixed footpeg

FTRS003

€ 385,00

Poggiapiede snodato  
Fold up footpeg

FTRS003W

€ 437,00

**GSX-S 1000**

TRACK SYSTEM

TÜV HOMOLOGATED

Anno / Year: 15-20

Cambio / Shifting: standard - reverse

"R" version

FTRS003R

€ 598,00





**DAYTONA 675 / 765  
STREET TRIPLE 675 / 765**

TRACK  
SYSTEM

TÜV HOMOLOGATED

(tutte le versioni / all versions)

Anno / Year: 13-20  
Cambio / Shifting: standard - reverse

Poggiapiède fisso  
Fixed footpeg FTRTR005 € 385,00

Poggiapiède snodato  
Fold up footpeg FTRTR005W € 437,00



**DAYTONA 675 / 765  
STREET TRIPLE 675 / 765**

TRACK  
SYSTEM

TÜV HOMOLOGATED

(tutte le versioni / all versions)

Anno / Year: 13-20  
Cambio / Shifting: standard - reverse

"R" version FTRTR005R € 598,00



**MT-07**  
**MT-07 TRACER**

TÜV HOMOLOGATED

Anno / Year: 14-20

Cambio / Shifting: standard

|                   |          |          |
|-------------------|----------|----------|
| Poggiapiede fisso |          |          |
| Fixed footpeg     | FTRYA008 | € 385,00 |

|                     |           |          |
|---------------------|-----------|----------|
| Poggiapiede snodato |           |          |
| Fold up footpeg     | FTRYA008W | € 437,00 |

**MT-07**  
**MT-07 TRACER**

TÜV HOMOLOGATED

Anno / Year: 14-20

Cambio / Shifting: standard

|             |           |          |
|-------------|-----------|----------|
| "R" version | FTRYA008R | € 598,00 |
|-------------|-----------|----------|



**MT-09  
MT-09 TRACER  
XSR900**

TÜV HOMOLOGATED

Anno / Year: 13-20

Cambio / Shifting: standard

|                                    |          |          |
|------------------------------------|----------|----------|
| Poggiapiède fisso<br>Fixed footpeg | FTRYA007 | € 385,00 |
|------------------------------------|----------|----------|

|  |           |          |
|--|-----------|----------|
| Poggiapiède snodato<br>Fold up footpeg | FTRYA007W | € 437,00 |
|--|-----------|----------|



**MT-09  
MT-09 TRACER  
XSR900**

TÜV HOMOLOGATED

Anno / Year: 13-20

Cambio / Shifting: standard

|             |           |          |
|-------------|-----------|----------|
| "R" version | FTRYA007R | € 598,00 |
|-------------|-----------|----------|

**MT-10**  
**MT-10 SP**

TÜV HOMOLOGATED

Anno / Year: 16-20

Cambio / Shifting: standard - reverse

 Poggiapiede fisso  
 Fixed footpeg

FTRYA011 € 447,00

 Poggiapiede snodato  
 Fold up footpeg

FTRYA011W € 499,00

**MT-10**  
**MT-10 SP**

TÜV HOMOLOGATED

Anno / Year: 16-20

Cambio / Shifting: standard - reverse

"R" version

FTRYA011R € 660,00



## PEDANE REGOLABILI

50 ADJUSTABLE REAR SETS

KBA 90967

YAMAHA



### R1 R1M

TRACK  
SYSTEM

TÜV HOMOLOGATED

Anno / Year: 15-21

Cambio / Shifting: standard - reverse

Poggiapiede fisso  
Fixed footpeg

FTRYA016

€ 415,00

Poggiapiede snodato  
Fold up footpeg

FTRYA016W

€ 465,00



### R1 R1M

TRACK  
SYSTEM

TÜV HOMOLOGATED

Anno / Year: 15-21

Cambio / Shifting: standard - reverse

"R" version

FTRYA016R

€ 625,00



Staffa di supporto per leva cambio e catalizzatore per R1 dal 2020.  
Permette rimozione cavalletto laterale.

Support bracket for gear lever and catalyst for R1 from 2020.  
It allows the removal of side stand.

Anno / Year: 20-21

FTR862NER

€ 52,00



Staffa di supporto per leva cambio per R1 dal 2015-2019. Permette rimozione cavalletto laterale.  
Support bracket for gear lever for R1 from 2015 to 2019. It allows the removal of side stand.

Anno / Year: 15-19

FTR632

€ 46,00

**R1**

TÜV HOMOLOGATED

Anno / Year: 09-14

Cambio / Shifting: standard - reverse

 Poggiapiede fisso  
 Fixed footpeg

FTRYA001

€ 385,00

 Poggiapiede snodato  
 Fold up footpeg

FTRYA001W

€ 437,00

**R1**

TÜV HOMOLOGATED

Anno / Year: 09-14

Cambio / Shifting: standard - reverse

"R" version

FTRYA001R

€ 598,00

## PEDANE REGOLABILI

52 ADJUSTABLE REAR SETS

KBA 90967

YAMAHA



### R3

TRACK SYSTEM

TÜV HOMOLOGATED

Anno / Year: 15-21

Cambio / Shifting: standard

PoggiapiEDE fisso  
Fixed footpeg FTRYA013 € 385,00

PoggiapiEDE snodato  
Fold up footpeg FTRYA013W € 437,00

Cambio / Shifting: reverse

PoggiapiEDE fisso  
Fixed footpeg FTRYA014 € 411,00

PoggiapiEDE snodato  
Fold up footpeg FTRYA014W € 463,00

### R3

TRACK SYSTEM

TÜV HOMOLOGATED

Anno / Year: 15-21

Cambio / Shifting: standard

"R" version FTRYA013R € 598,00

Cambio / Shifting: reverse

"R" version FTRYA014R € 623,00



**R6**TRACK  
SYSTEM

TÜV HOMOLOGATED

Anno / Year: 17-21

Cambio / Shifting: standard - reverse

Poggiapiede fisso  
Fixed footpeg

FTRYA012 € 411,00

Poggiapiede snodato  
Fold up footpeg

FTRYA012W € 463,00

**R6**TRACK  
SYSTEM

TÜV HOMOLOGATED

Anno / Year: 17-21

Cambio / Shifting: standard - reverse

"R" version

FTRYA012R € 623,00





**R6**

TÜV HOMOLOGATED

Anno / Year: 08 -16

Cambio / Shifting: standard - reverse

Poggiapiède fisso  
Fixed footpeg FTRYA002 € 385,00

Poggiapiède snodato  
Fold up footpeg FTRYA002W € 437,00



**R6**

TÜV HOMOLOGATED

Anno / Year: 08-16

Cambio / Shifting: standard - reverse

"R" version FTRYA002R € 598,00











**COMPONENTI  
RICAMBIO PER PEDANE  
REAR SET SPARE PARTS**

Colori disponibili - Available colours:

silver  
silver

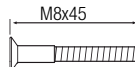

| <b>Poggia piede fisso</b><br><b>Fixed footpeg</b>   |   |   |  | <b>Codice - Code</b> | <b>a pezzo - for piece</b> |
|---|---|---|--|----------------------|----------------------------|
| Poggia piede fisso + vite M8x20<br>Fixed footpeg + bolt M8x20                                   |    | + |  M8x20   | =                    | RFTR245<br>€ 28,00         |
| Poggia piede fisso + vite M8x25<br>Fixed footpeg + bolt M8x25                                   |   | + |  M8x25  | =                    | RFTR246<br>€ 28,00         |
| Poggia piede fisso + vite M8x45<br>Fixed footpeg + bolt M8x45                                   |  | + |  M8x45 | =                    | RFTR247<br>€ 28,00         |
| Poggia piede fisso + vite testa cilindrica M8x20<br>Fixed footpeg + cylindrical head bolt M8x20 |  | + |  M8x20 | =                    | RFTR248<br>€ 28,00         |

Colori disponibili - Available colours:

silver  
silver





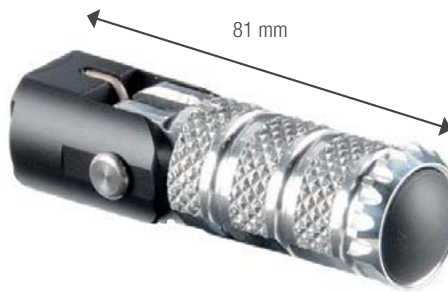

cobalto  
cobalt

nero  
black

rosso  
red

oro  
gold

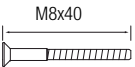







| <b>Poggia piede snodato</b><br><b>Folding footpeg</b>   |   |   |  | <b>Codice - Code</b> | <b>a pezzo - for piece</b> |
|---|---|---|--|----------------------|----------------------------|
| Poggia piede snodato + vite M8x20<br>Folding footpeg + bolt M8x20                                   |  | + |  M8x20 | =                    | RFTR249<br>€ 43,00         |
| Poggia piede snodato + vite M8x25<br>Folding footpeg + bolt M8x25                                   |  | + |  M8x25 | =                    | RFTR250<br>€ 43,00         |
| Poggia piede snodato + vite M8x40<br>Folding footpeg + bolt M8x40                                   |  | + |  M8x40 | =                    | RFTR251<br>€ 43,00         |
| Poggia piede snodato + vite testa cilindrica M8x20<br>Folding footpeg + cylindrical head bolt M8x20 |  | + |  M8x20 | =                    | RFTR252<br>€ 43,00         |



Colori disponibili - Available colours:

nero  
black

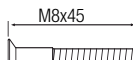

| Poggia piede fisso<br>Fixed footpeg   |   |   |  | Codice - Code | a pezzo - for piece |
|---|---|---|--|---------------|---------------------|
| Poggia piede fisso + vite M8x20<br>Fixed footpeg + bolt M8x20                                   |    | + |    | RFTR189       | € 19,00             |
| Poggia piede fisso + vite M8x25<br>Fixed footpeg + bolt M8x25                                   |    | + |    | RFTR45        | € 19,00             |
| Poggia piede fisso + vite M8x45<br>Fixed footpeg + bolt M8x45                                   |  | + |  | RFTR32        | € 19,00             |
| Poggia piede fisso + vite testa cilindrica M8x20<br>Fixed footpeg + cylindrical head bolt M8x20 |  | + |  | RFTR178       | € 19,00             |



HIGH  
GRIP

# COMPONENTI RICAMBIO PER PEDANE



cobalto / cobalt



rosso / red



silver / silver



nero / black



verde / green

Supporto poggia piede  
Footpeg holder

FTR704 € 26,00

a pezzo - for piece



rosso / red



silver / silver



nero / black

Supporto poggia piede lato freno  
Footpeg holder brake side

FTR507 € 26,00

a pezzo - for piece



rosso / red



silver / silver



nero / black

Supporto poggia piede lato cambio  
Footpeg holder shift side

FTR508 € 26,00

a pezzo - for piece



cobalto / cobalt



silver / silver



nero / black



rosso / red



Kit supporti poggia piedi "UP&DOWN" per avere più combinazioni di regolazione (escluse viti di fissaggio)  
Supports kit for footpegs "UP&DOWN" to allow multiple combinations (fitting bolts not included)

RFTR244\* € 52,00

\* Verificare compatibilità / Always check compatibility

a kit - for kit

### Esempi di possibili configurazioni / Examples of possible configurations:

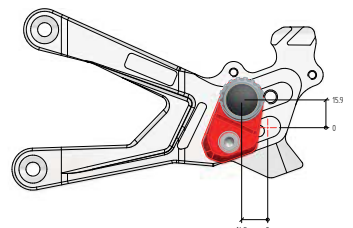
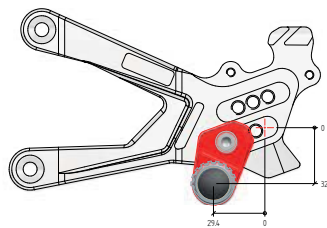
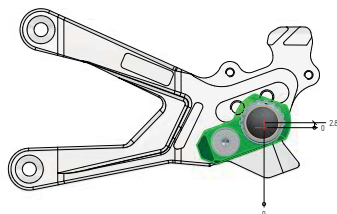
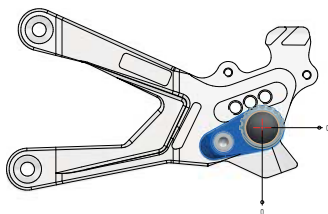



Vite per FTR704 / RFTR244  
Bolt for FTR704 / RFTR244

|        |        |
|--------|--------|
| FTR690 | € 5,00 |
|--------|--------|



Vite per FTR507 / FTR508  
Bolt for FTR507 / FTR508

|        |        |
|--------|--------|
| FTR760 | € 5,50 |
|--------|--------|



Vite per FTR507 / FTR508  
Bolt for FTR507 / FTR508

|             |        |
|-------------|--------|
| V005M8020ZB | € 0,50 |
|-------------|--------|



Vite per FTR507 / FTR508  
Bolt for FTR507 / FTR508

|        |        |
|--------|--------|
| FTR760 | € 5,50 |
|--------|--------|

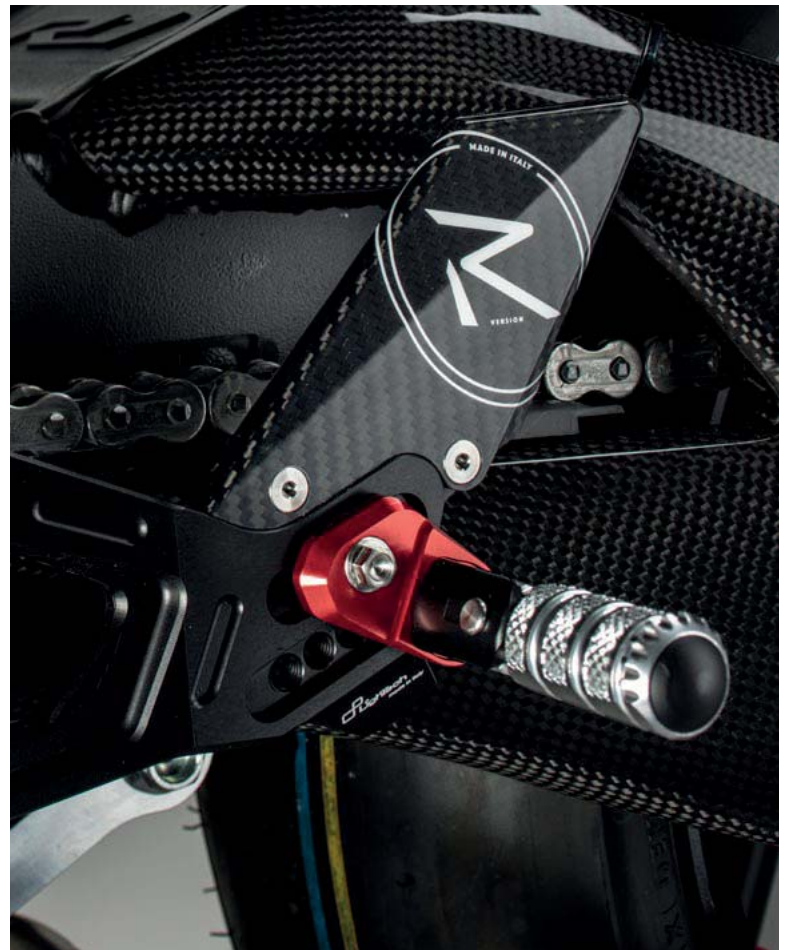

# COMPONENTI RICAMBIO PER PEDANE

## 60 REAR SET SPARE PARTS



Paratacco in carbonio "White R"  
Carbon heel guard "White R" FTR796 € 43,70



Paratacco in carbonio "White R"  
Carbon heel guard "White R" FTR795 € 43,70



Paratacco in alluminio  
Aluminium heel guard FTR419SIL € 42,00



Paratacco in alluminio  
Aluminium heel guard FTR418SIL € 42,00



Paratacco in carbonio  
Carbon heel guard FTR470 € 39,50



Paratacco in carbonio  
Carbon heel guard FTR471 € 39,50



Paratacco in magnesio  
Magnesium heel guard FTR468NER € 23,00



Paratacco in magnesio  
Magnesium heel guard FTR469NER € 23,00



Puntalino snodato  
Folding front toe peg  
RFTR154 € 34,00



Puntalino snodato  
Folding front toe peg  
RFTR156 € 34,00



Puntalino  
Front toe peg  
RFTR52 € 15,00

Aluminium



Puntalino snodato  
Folding front toe peg  
RFTR213SIL € 36,00

Aluminium



Puntalino snodato  
Folding front toe peg  
RFTR214SIL € 36,00



Supporto puntalino  
Toe peg holder  
FTR290 € 9,00

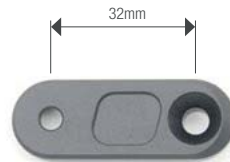

Supporto puntalino  
Toe peg holder  
FTR799 € 15,00



Millerighe  
Gear shift arm  
FTR236 € 29,00



Millerighe  
Gear shift arm  
FTR429 € 29,00



Uniball  
Mas M6 dx  
Mas M6 sx  
VAR1036  
VAR1077 € 8,50



Uniball  
Fem M6 dx  
Fem M6 sx  
VAR1095  
VAR1076 € 8,50

## COMPONENTI RICAMBIO PER PEDANE

62 REAR SET SPARE PARTS



Interruttore stop idraulico (M10 x 1,25)  
Hydraulic stop switch (M10 x 1,25)

RFTR93 € 16,50



Interruttore stop idraulico (M10 x 1)  
Hydraulic stop switch (M10 x 1)

RFTR128 € 16,50

Alluminio - Aluminium

€ 16,00

mm 100 FTR741  
mm 110 FTR734  
mm 120 FTR742  
mm 130 FTR495  
mm 140 FTR518  
mm 155 FTR 75  
mm 165 FTR 252  
mm 180 FTR 184  
mm 190 FTR 62  
mm 197 FTR 97  
mm 205 FTR 163  
mm 220 FTR 238  
mm 240 FTR 32



Inox - Stainless Steel

€ 16,00

mm 85 FTR 669  
mm 100 FTR 666  
mm 130 FTR 644  
mm 145 FTR 546  
mm 165 FTR 329  
mm 175 FTR 228  
mm 190 FTR 56





**POGGIAPIEDI PER  
PEDANE ORIGINALI**  
FOOTPEGS FOR  
ORIGINAL REAR SETS



# POGGIAPIEDI PER PEDANE ORIGINALI

64 FOOTPEGS FOR ORIGINAL REAR SETS



rosso  
red

cobalto  
cobalt

nero  
black

oro  
gold

verde  
green

silver  
silver

|   |        |                     |
|---|--------|---------------------|
| Poggiapiedi per pedane originali<br>Footpegs for original rear sets | FTP100 | a coppia - for pair |
|   |        | € 50,00             |

Necessitano di adattatori specifici  
Specific adaptors required

| Modello - Model | Anno - Year | Codice - Code     | Codice - Code     | €                   |
|-----------------|-------------|-------------------|-------------------|---------------------|
|                 |             |                   |                   |                     |
|                 |             | anteriore - front | posteriore - rear | a coppia - for pair |

| BMW                                  |    |    |        |        |       |
|--------------------------------------|----|----|--------|--------|-------|
| R Nine-T /Scrambler/Pure/Urban/Racer | 16 | 18 | -      | FTP029 | 29,00 |
| S1000RR                              | 15 | 18 | FTP025 | FTP026 | 29,00 |

| HONDA           |    |    |        |        |       |
|-----------------|----|----|--------|--------|-------|
| CB 125R         | 18 | 20 | FTP012 | FTP007 | 29,00 |
| CB 600 HORNET   | 07 | 13 | FTP012 | FTP007 | 29,00 |
| CB 650 F        | 14 | 19 | FTP012 | FTP007 | 29,00 |
| CB 1000R / ABS  | 08 | 17 | FTP002 | FTP007 | 29,00 |
| CB 1000R        | 18 | 20 | FTP012 | FTP007 | 29,00 |
| CBR 600F        | 11 | 14 | FTP012 | FTP007 | 29,00 |
| CBR 600RR / ABS | 03 | 16 | FTP002 | FTP007 | 29,00 |
| CBR 1000RR      | 04 | 13 | FTP002 | FTP007 | 29,00 |
| CBR 1000RR-R    | 20 | 20 | -      | FTP007 | 29,00 |
| INTEGRA         | 15 | 17 | -      | FTP007 | 29,00 |

| Modello - Model | Anno - Year |    | Codice - Code     |                   | €     |
|-----------------|-------------|----|-------------------|-------------------|-------|
|                 |             |    | anteriore - front | posteriore - rear |       |
| <b>KAWASAKI</b> |             |    |                   |                   |       |
| ER6 F/N         | 06          | 08 | FTP003            | FTP009            | 29,00 |
| Z650            | 17          | 20 | FTP031            | FTP009            | 29,00 |
| Z750/R          | 04          | 12 | FTP003            | FTP009            | 29,00 |
| Z800            | 13          | 16 | FTP003            | FTP009            | 29,00 |
| Z900            | 17          | 20 | FTP031            | FTP009            | 29,00 |
| Z1000           | 03          | 09 | FTP003            | FTP009            | 29,00 |
| Z1000           | 10          | 19 | FTP004            | FTP009            | 29,00 |
| Z1000SX         | 11          | 17 | FTP003            | FTP009            | 29,00 |
| ZX6-R           | 05          | 06 | FTP003            | FTP009            | 29,00 |
| ZX6-R           | 07          | 20 | FTP004            | FTP009            | 29,00 |
| ZX10R           | 08          | 10 | FTP004            | FTP009            | 29,00 |
| ZX10R           | 11          | 20 | -                 | FTP009            | 29,00 |

|                             |    |    |        |        |       |
|-----------------------------|----|----|--------|--------|-------|
| <b>MV</b>                   |    |    |        |        |       |
| BRUTALE 675 / 800           | 12 | 16 | FTP014 | FTP015 | 29,00 |
| BRUTALE 920                 | 10 | 11 | FTP014 | FTP015 | 29,00 |
| BRUTALE 1090-R / RR / CORSA | 12 | 13 | FTP014 | FTP015 | 29,00 |
| DRAGSTER                    | 14 | 16 | FTP014 | FTP015 | 29,00 |
| F3 675 / 800 / AGO          | 12 | 18 | FTP014 | FTP015 | 29,00 |
| F4-S / R / RR               | 13 | 18 | FTP014 | FTP015 | 29,00 |
| RIVALE                      | 14 | 16 | FTP014 | FTP015 | 29,00 |
| STRADALE                    | 15 | 16 | FTP014 | FTP015 | 29,00 |

|                  |    |    |        |        |       |
|------------------|----|----|--------|--------|-------|
| <b>SUZUKI</b>    |    |    |        |        |       |
| GSR600           | 06 | 10 | FTP005 | FTP008 | 29,00 |
| GSR750           | 11 | 16 | FTP005 | FTP008 | 29,00 |
| GSZ1300 HAYABUSA | 08 | 14 | FTP005 | FTP008 | 29,00 |
| GSX- R600        | 08 | 17 | FTP005 | FTP008 | 29,00 |
| GSX- R750        | 08 | 17 | FTP005 | FTP008 | 29,00 |
| GSX- R1000       | 09 | 20 | FTP005 | FTP008 | 29,00 |
| GSX- S125        | 17 | 20 | FTP005 | FTP008 | 29,00 |
| GSX-S 750        | 17 | 20 | FTP005 | FTP008 | 29,00 |
| GSX-S 1000       | 15 | 20 | FTP005 | FTP008 | 29,00 |
| KATANA           | 19 | 20 | FTP005 | FTP008 | 29,00 |
| SFV 650 Gladius  | 09 | 14 | FTP005 | FTP008 | 29,00 |

|                            |    |    |        |        |       |
|----------------------------|----|----|--------|--------|-------|
| <b>TRIUMPH</b>             |    |    |        |        |       |
| SPEED TRIPLE/ R            | 11 | 20 | FTP010 | FTP030 | 29,00 |
| STREET TRIPLE/ R / DAYTONA | 11 | 20 | FTP010 | FTP030 | 29,00 |

|               |    |    |        |        |       |
|---------------|----|----|--------|--------|-------|
| <b>YAMAHA</b> |    |    |        |        |       |
| FZ1 / Fazer   | 06 | 12 | -      | FTP022 | 29,00 |
| FZ8 / Fazer   | 11 | 13 | -      | FTP022 | 29,00 |
| MT-03         | 16 | 17 | FTP019 | -      | 29,00 |
| MT-07         | 14 | 20 | FTP019 | FTP022 | 29,00 |
| MT-09         | 14 | 20 | FTP019 | FTP022 | 29,00 |
| MT-10         | 16 | 20 | FTP019 | FTP022 | 29,00 |
| T-MAX         | 03 | 20 | -      | FTP022 | 29,00 |
| YZF-R1        | 09 | 14 | -      | FTP021 | 29,00 |
| YZF-R1        | 15 | 20 | FTP027 | FTP028 | 29,00 |
| YZF-R3        | 15 | 20 | -      | FTP022 | 29,00 |
| YZF-R6        | 06 | 20 | FTP016 | FTP021 | 29,00 |

**BORN  
TO BE  
MOTO**





**TENDICATENA**  
CHAIN ADJUSTER



RAPIDO E PRECISO / FAST AND ACCURATE

Permette uno spostamento di 0,25mm ad ogni click  
To adjust simply turn the small adjuster by hand:  
1 click = 0.25mm

Regolazione esterna a vite per una regolazione veloce e precisa  
External bolt allows precise adjustment first time every time

Scala graduata incisa al laser  
Metric scale is stamped into the alloy



Realizzati in ergal 7075  
CNC machined from billet Ergal 7075

Forchetta disponibile come optional per l'utilizzo di cavalletti a rulli  
Lifters (supplied as option) allows you to use spool-type rear stands for a more secure lift



COLORI DISPONIBILI / AVAILABLE COLOURS



oro  
gold

cobalto  
cobalt

nero  
black

rosso  
red

verde  
green

| Modello - Model   |   | Anno - Year |    | Codice - Code | €                   |        |
|---|---|-------------|----|---------------|---------------------|--------|
|   |   |             |    |               | a coppia - for pair |        |
| <b>APRILIA</b>  |   |             |    |               |                     |        |
| RS 660  |   | ■ ■         | 20 | 21            | TEAP004             | 206,00 |
| RSV4 R / Factory / APRC   |   | ■ ■         | 09 | 14            | TEAP001             | 191,00 |
| RSV4 RR / RF / APRC   |   | ■ ■         | 15 | 20            | TEAP003             | 206,00 |
| RSV4 1100 Factory   |   | ■ ■         | 19 | 20            | TEAP003             | 206,00 |
| TUONO V4  |   | ■ ■         | 11 | 14            | TEAP001             | 191,00 |
| TUONO V4 / 1100 Factory   |   | ■ ■         | 15 | 20            | TEAP003             | 206,00 |
| <b>BMW</b>  |   |             |    |               |                     |        |
| S1000 R   |   | ■ ■ ■ ■     | 14 | 20            | TEBM002             | 206,00 |
| S1000 RR  |   | ■ ■ ■ ■     | 09 | 18            | TEBM002             | 206,00 |
| S1000 RR  |   | ■ ■ ■ ■     | 19 | 20            | TEBM003             | 206,00 |
| <b>HONDA</b>  |   |             |    |               |                     |        |
| CBR 600RR   |   | ■ ■         | 07 | 17            | TEH0002             | 206,00 |
| CBR 1000RR  |   | ■ ■         | 08 | 16            | TEH0002             | 206,00 |
| CBR 1000RR-R / SP   |   | ■ ■         | 20 | 20            | TEH0004             | 240,00 |
| XADV  |   | ■ ■ ■       | 17 | 20            | TEH0003             | 206,00 |
| <b>KAWASAKI</b>   |   |             |    |               |                     |        |
| Z900  |   | ■ ■ ■       | 17 | 20            | TEKA004             | 206,00 |
| ZX6R / 636  | Si consiglia di sostituire il dado perno ruota originale con un dado ribassato*<br>We recommend to change the OEM wheel nut with a lower one* | ■ ■ ■       | 09 | 20            | TEKA005             | 206,00 |
| ZX10R   | Si consiglia di sostituire il dado perno ruota originale con un dado ribassato*<br>We recommend to change the OEM wheel nut with a lower one* | ■ ■ ■       | 11 | 15            | TEKA003             | 206,00 |
| ZX10R   | Si consiglia di sostituire il dado perno ruota originale con un dado ribassato*<br>We recommend to change the OEM wheel nut with a lower one* | ■ ■ ■       | 16 | 20            | TEKA002             | 206,00 |
|  |   |             |    |               |                     |        |
| DADO RIBASSATO / LOWER NUT *  |   |             |    |               | D024                | 51,00  |
| <b>SUZUKI</b>   |   |             |    |               |                     |        |
| GSX-R 600 / 750   |   | ■ ■ ■       | 11 | 17            | TESU004             | 206,00 |
| GSX-R 1000  |   | ■ ■ ■       | 09 | 16            | TESU009             | 206,00 |
| GSX-R 1000 / R  |   | ■ ■ ■       | 17 | 20            | TESU008             | 206,00 |
| GSX-S 1000  |   | ■ ■ ■       | 15 | 20            | TESU007             | 206,00 |

# TENDITORI CATENA

70 CHAIN ADJUSTERS

| Modello - Model   | Anno - Year | Codice - Code | €      |
|---|-------------|---------------|--------|
| <b>a coppia - for pair</b>  |             |               |        |
| <b>YAMAHA</b>   |             |               |        |
| MT-09   | 13 16       | TEYA002       | 191,00 |
| MT-09 Tracer / XSR900   | 13 20       | TEYA002       | 191,00 |
| MT-10   | 16 20       | TEYA003       | 206,00 |
| R1  | 09 14       | TEYA004       | 206,00 |
| R1 / R1 M   | 15 19       | TEYA003       | 206,00 |
| R1 / R1 M   | 20 20       | TEYA005       | 206,00 |
| R6  | 06 16       | TEY608        | 161,00 |
| R6  | 17 20       | TEYA006       | 206,00 |
| R6 Con supporto pinza integrato<br>Brake caliper support integrated | 17 20       | TEYA008       | 250,00 |
| T-MAX 530 / 560   | 12 21       | TEYA001       | 186,00 |

## TENDICATENA CON SUPPORTO PINZA FRENO CHAIN ADJUSTER WITH BRAKE CALIPER SUPPORT

**FOR RACING USE ONLY**

YAMAHA R6 (2017-2020) | TEYA008 | € 250,00



YAMAHA R6 (2006-2016) | TEY608 | € 161,00





**I VANTAGGI DELLA FORCHETTA RACING**  
**THE ADVANTAGES OF RACING LIFTER**

- 1.** Innesto rapido del cavalletto.  
Quick lift for rear stand use.
- 2.** Evita rotture del forcellone in caso di scivolate.  
Avoid damage for swingarm in case of slide.
- 3.** Impiegando il cavalletto a rulli, si evitano graffi accidentali.  
Avoid scratches if used with rear stand with rollers.

Colori disponibili - Available colours:

■ silver  
■ silver

FINE SERIE - END STOCK

| Modello<br>Model                   | Anno<br>Year |    | Codice<br>Code | €            | Compatibile con<br>Compatible with |
|------------------------------------|--------------|----|----------------|--------------|------------------------------------|
|                                    |              |    |                |              |                                    |
| <b>APRILIA</b>                     |              |    |                |              |                                    |
| APRILIA RS 660                     | 20           | 21 | FTEAP004       | <b>61,00</b> | TEAP004                            |
| RSV4 R / FACTORY / APRC            | 09           | 14 | FTEAP001       | <b>37,00</b> | TEAP001                            |
| RSV4 RR / RF / APRC / 1100 Factory | 15           | 20 | FTEAP002       | <b>61,00</b> | TEAP003                            |
| TUONO V4                           | 11           | 14 | FTEAP001       | <b>37,00</b> | TEAP001                            |
| TUONO V4 / 1100 Factory            | 15           | 20 | FTEAP002       | <b>61,00</b> | TEAP003                            |
| <b>BMW</b>                         |              |    |                |              |                                    |
| S1000 R                            | 09           | 20 | FTEBM002       | <b>50,00</b> | TEBM002                            |
| S1000 RR                           | 09           | 18 | FTEBM002       | <b>50,00</b> | TEBM002                            |
| S1000 RR                           | 19           | 20 | FTEBM003       | <b>61,00</b> | TEBM003                            |
| <b>HONDA</b>                       |              |    |                |              |                                    |
| CBR 600 RR                         | 07           | 17 | FTEH002        | <b>50,00</b> | TEH002                             |
| CBR 1000 RR                        | 06           | 16 | FTEH002        | <b>50,00</b> | TEH002                             |
| CBR 1000RR-R / SP                  | 20           | 20 | FTEH004        | <b>61,00</b> | TEH004                             |
| <b>KAWASAKI</b>                    |              |    |                |              |                                    |
| ZX6R                               | 09           | 20 | FTEKA005       | <b>50,00</b> | TEKA005                            |
| ZX10R                              | 11           | 15 | FTEKA003       | <b>61,00</b> | TEKA003                            |
| ZX10R                              | 16           | 20 | FTEKA007       | <b>61,00</b> | TEKA002                            |
| <b>SUZUKI</b>                      |              |    |                |              |                                    |
| GSXR 1000 / R                      | 17           | 20 | FTESU002       | <b>61,00</b> | TESU008                            |
| <b>YAMAHA</b>                      |              |    |                |              |                                    |
| R1                                 | 09           | 14 | FTEYA004       | <b>50,00</b> | TEYA004                            |
| R1 / R1 M                          | 15           | 19 | FTEYA003       | <b>50,00</b> | TEYA003                            |
| R1 / R1 M                          | 20           | 20 | FTEYA005       | <b>61,00</b> | TEYA005                            |
| R6                                 | 17           | 20 | FTEYA006       | <b>61,00</b> | TEYA006                            |

NEW!

NEW!

# SUPPORTI PER CAVALLETTI

## NEW DESIGN, SMART PLUG

- Nuovi supporti cavalletto
- Disponibili in tutte le combinazioni colore
- Ottimizzazione degli stock grazie all'intercambiabilità del CAP001 tra SCV001-002 e KTM serie 400 (vedi pag. 98)
- New swing arm spools
- Available in all color combinations
- Stock optimization thanks to the interchangeability of the CAP001 between SCV001-002 and KTM 400 series (see page 98)

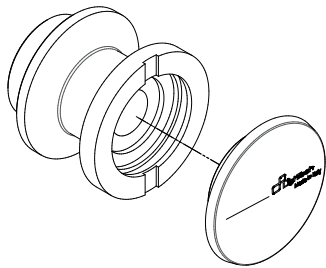

Compatibile con nuova serie **KTM 400**  
Interchangeable cap with the new **KTM400** series



| Misura - Measure    | Modello - Model                               |   | Codice - Code | €     |
|---------------------|---|---|---------------|-------|
| a coppia - for pair |   |   |               |       |
| M6                  | Yamaha, Aprilia, Triumph, Panigale 899-959    | ■ | SCV001        | 12,00 |
| M8                  | Suzuki, Honda, Bmw, Kawasaki, Triumph 675-765 | ■ | SCV002        | 12,00 |

\* Verificare compatibilità / Always check compatibility



|   | Codice - Code | €     |
|---|---------------|-------|
| a coppia - for pair                                     |               |       |
| Kit tappi colorati per SCV<br>Coloured caps kit for SCV | CAP001        | 11,00 |



rosso  
red

verde  
green

nero  
black

oro  
gold

cobalto  
cobalt

silver  
silver

| Misura - Measure | Codice - Code   | €                   |
|------------------|---|---------------------|
|                  |   | a coppia - for pair |
| M6               | CAVM6 (Aprilia* / Ducati Panigale 899 - 959 / Yamaha*)          | 17,00               |
| M8               | CAVM8 (BMW* / Honda* / Kawasaki* / Suzuki* / Triumph 675 - 765) | 17,00               |
| M10 X 1,50       | CAVM1015 (KTM*)   | 19,00               |
| M10 x 1,25       | CAVM10 (Kawasaki*)  | 19,00               |

\* Verificare compatibilità / Always check compatibility



## SUPPORTI PER CAVALLETTI

74 SWING ARM SPOOLS



■ silver  
silver

a coppia - for pair

|   | Codice - Code | €     |
|---|---------------|-------|
| Forchetta per Kawasaki ZX10R (2016→)          | FTEKA006      | 46,00 |
| Paddock stand fork for Kawasaki ZX10R (2016→) |               |       |



■ nero black  
■ cobalto cobalt  
■ rosso red

a coppia - for pair

|  | Codice - Code | €     |
|--|---------------|-------|
| Forchetta per Yamaha R1 (2015→) / MT10 (2016→) / R6 (2017→)          | FTEYA007      | 59,00 |
| Paddock stand fork for Yamaha R1 (2015→) / MT10 (2016→) / R6 (2017→) |               |       |





**LEVE**  
**LEVERS**

GRIP INNOVATION

- Realizzate in magnesio per ridurre il peso
- Versione "Alien" per un miglior grip
- 100% Made in Italy
- Magnesium levers to reduce weight
- "Alien" version for better grip
- 100% Made in Italy



**ALIEN**  
GRIP

con inserti in gomma  
with rubber inserts

Extra grip  
100% Made in Italy  
Final Code: \_\_\_K



Extra light  
100% Made in Italy  
Final Code: \_\_\_J

KBA 91595

Colori disponibili: nero / Available colours: black

| Modello - Model | TÜV KBA 91595 | Anno- Year | Codice - Code | € | Codice - Code | € |
|-----------------|---------------|------------|---------------|---|---------------|---|
|-----------------|---------------|------------|---------------|---|---------------|---|



| APRILIA                           |             |    |    |          |        |          |        |
|-----------------------------------|-------------|----|----|----------|--------|----------|--------|
| RS 660                            | NO          | 20 | 21 | KLEV101J | 166,00 | KLEV101K | 181,00 |
| RSV1000                           | YES         | 04 | 09 | KLEV100J | 177,00 | KLEV100K | 192,00 |
| RSV4 R / RR / RF / Factory / APRC | YES (09-16) | 09 | 20 | KLEV101J | 166,00 | KLEV101K | 181,00 |
| RSV4 1100 Factory                 | NO          | 19 | 20 | KLEV101J | 166,00 | KLEV101K | 181,00 |
| TUONO V4 RR / 1100 Factory        | NO          | 17 | 20 | KLEV101J | 166,00 | KLEV101K | 181,00 |

| BMW      |     |    |    |          |        |          |        |
|----------|-----|----|----|----------|--------|----------|--------|
| S1000 R  | YES | 14 | 20 | KLEV102J | 166,00 | KLEV102K | 181,00 |
| S1000 RR | YES | 09 | 14 | KLEV103J | 166,00 | KLEV103K | 181,00 |
| S1000 RR | YES | 15 | 18 | KLEV102J | 166,00 | KLEV102K | 181,00 |
| S1000 RR | NO  | 19 | 20 | KLEV120J | 177,00 | KLEV120K | 192,00 |

| Modello - Model | TÜV KBA 91595 | Anno - Year | Codice - Code | € | Codice - Code | € |
|-----------------|---------------|-------------|---------------|---|---------------|---|
|-----------------|---------------|-------------|---------------|---|---------------|---|



| DUCATI                   |             |    |    |          |        |          |        |
|--------------------------|-------------|----|----|----------|--------|----------|--------|
| 749 - 999                | YES         | 02 | 06 | KLEV104J | 177,00 | KLEV104K | 192,00 |
| 848 - 1098 - 1198        | YES         | 07 | 11 | KLEV104J | 177,00 | KLEV104K | 192,00 |
| Diavel                   | YES         | 11 | 18 | KLEV104J | 177,00 | KLEV104K | 192,00 |
| Monster 1100             | YES         | 10 | 13 | KLEV104J | 177,00 | KLEV104K | 192,00 |
| Monster 1200 / R         | YES (14-16) | 14 | 20 | KLEV104J | 177,00 | KLEV104K | 192,00 |
| Panigale 899             | YES         | 12 | 16 | KLEV104J | 177,00 | KLEV104K | 192,00 |
| Panigale 959             | YES         | 16 | 20 | KLEV104J | 177,00 | KLEV104K | 192,00 |
| Panigale 1199            | YES         | 12 | 16 | KLEV104J | 177,00 | KLEV104K | 192,00 |
| Panigale 1299            | YES         | 15 | 17 | KLEV104J | 177,00 | KLEV104K | 192,00 |
| Panigale V4 /S           | YES (18-18) | 18 | 20 | KLEV104J | 177,00 | KLEV104K | 192,00 |
| Panigale V2              | NO          | 20 | 20 | KLEV104J | 177,00 | KLEV104K | 192,00 |
| Streetfighter 848 / 1100 | YES         | 09 | 16 | KLEV104J | 177,00 | KLEV104K | 192,00 |
| Streetfighter V4         | NO          | 20 | 20 | KLEV104J | 177,00 | KLEV104K | 192,00 |

| HONDA              |     |    |    |          |        |          |        |
|--------------------|-----|----|----|----------|--------|----------|--------|
| CB 1000 R          | YES | 08 | 17 | KLEV110J | 177,00 | KLEV110K | 192,00 |
| CB 1000 R          | NO  | 18 | 20 | KLEV109J | 166,00 | KLEV109K | 181,00 |
| CBR 600 RR         | YES | 07 | 17 | KLEV109J | 166,00 | KLEV109K | 181,00 |
| CBR 1000 RR        | YES | 04 | 07 | KLEV110J | 177,00 | KLEV110K | 192,00 |
| CBR 1000 RR        | YES | 08 | 19 | KLEV109J | 166,00 | KLEV109K | 181,00 |
| CBR 1000 RR - R    | NO  | 20 | 20 | KLEV109J | 166,00 | KLEV109K | 181,00 |
| CBR 1000 RR - R SP | NO  | 20 | 20 | KLEV122J | 166,00 | KLEV122K | 181,00 |

| KAWASAKI     |             |    |    |          |        |          |        |
|--------------|-------------|----|----|----------|--------|----------|--------|
| Ninja 250    | NO          | 08 | 13 | KLEV117J | 160,00 | KLEV117K | 175,00 |
| Ninja 300    | YES         | 14 | 17 | KLEV117J | 160,00 | KLEV117K | 175,00 |
| Ninja 400    | YES         | 18 | 20 | KLEV117J | 160,00 | KLEV117K | 175,00 |
| Z650         | YES (17-19) | 17 | 20 | KLEV046J | 160,00 | KLEV046K | 175,00 |
| Z750         | YES         | 07 | 12 | KLEV027J | 160,00 | KLEV027K | 175,00 |
| Z750 R       | YES         | 11 | 12 | KLEV029J | 160,00 | KLEV029K | 175,00 |
| Z800         | YES         | 13 | 16 | KLEV027J | 160,00 | KLEV027K | 175,00 |
| Z900         | YES         | 17 | 20 | KLEV046J | 160,00 | KLEV046K | 175,00 |
| Z1000        | YES         | 07 | 16 | KLEV029J | 160,00 | KLEV029K | 175,00 |
| Z1000        | NO          | 17 | 20 | KLEV119J | 166,00 | KLEV119K | 181,00 |
| Z1000 SX     | YES         | 11 | 16 | KLEV029J | 160,00 | KLEV029K | 175,00 |
| Z1000 SX     | NO          | 17 | 20 | KLEV119J | 166,00 | KLEV119K | 181,00 |
| ZX6R / ZX636 | YES (05-16) | 05 | 18 | KLEV105J | 166,00 | KLEV105K | 181,00 |
| ZX636        | NO          | 19 | 20 | KLEV119J | 166,00 | KLEV119K | 181,00 |
| ZX10R        | YES         | 06 | 15 | KLEV105J | 166,00 | KLEV105K | 181,00 |
| ZX10R        | YES (16-17) | 16 | 20 | KLEV108J | 166,00 | KLEV108K | 181,00 |

| KTM      |    |    |    |          |        |          |        |
|----------|----|----|----|----------|--------|----------|--------|
| DUKE 790 | NO | 18 | 20 | KLEV118J | 177,00 | KLEV118K | 192,00 |

| MV     |             |    |    |          |        |          |        |
|--------|-------------|----|----|----------|--------|----------|--------|
| F3 675 | YES (12-16) | 12 | 20 | KLEV114J | 166,00 | KLEV114K | 181,00 |
| F3 800 | YES (13-16) | 13 | 20 | KLEV114J | 166,00 | KLEV114K | 181,00 |

| SUZUKI         |     |    |    |          |        |          |        |
|----------------|-----|----|----|----------|--------|----------|--------|
| GSXR 600 / 750 | YES | 06 | 17 | KLEV113J | 166,00 | KLEV113K | 181,00 |
| GSXR 1000      | YES | 05 | 06 | KLEV113J | 166,00 | KLEV113K | 181,00 |
| GSXR 1000      | YES | 09 | 16 | KLEV113J | 166,00 | KLEV113K | 181,00 |
| GSXR 1000 / R  | YES | 17 | 20 | KLEV113J | 166,00 | KLEV113K | 181,00 |
| GSXS 1000      | YES | 15 | 20 | KLEV113J | 166,00 | KLEV113K | 181,00 |

| Modello - Model | TÜV KBA 91595 | Anno- Year | Codice - Code | € | Codice - Code | € |
|-----------------|---------------|------------|---------------|---|---------------|---|
|-----------------|---------------|------------|---------------|---|---------------|---|



| <b>TRIUMPH</b>             |             |    |    |          |        |          |        |
|----------------------------|-------------|----|----|----------|--------|----------|--------|
| Daytona 675                | YES         | 06 | 12 | KLEV032J | 160,00 | KLEV032K | 175,00 |
| Daytona 675 R              | YES         | 11 | 16 | KLEV111J | 166,00 | KLEV111K | 181,00 |
| Street Triple 675 R        | YES (08-16) | 08 | 17 | KLEV032J | 160,00 | KLEV032K | 175,00 |
| Street Triple 765 RS       | NO          | 18 | 20 | KLEV111J | 166,00 | KLEV111K | 181,00 |
| Speed Triple 1050 / 1050 R | YES         | 08 | 10 | KLEV032J | 160,00 | KLEV032K | 175,00 |
| Speed Triple 1050 / 1050 R | YES         | 11 | 16 | KLEV111J | 166,00 | KLEV111K | 181,00 |

| <b>YAMAHA</b>         |             |    |    |          |        |          |        |
|-----------------------|-------------|----|----|----------|--------|----------|--------|
| FZ6 / Fazer           | YES         | 04 | 12 | KLEV115J | 160,00 | KLEV115K | 175,00 |
| FZ8                   | YES         | 10 | 16 | KLEV115J | 160,00 | KLEV115K | 175,00 |
| FZ1 / Fazer           | YES         | 06 | 16 | KLEV115J | 160,00 | KLEV115K | 175,00 |
| MT-07                 | YES (14-16) | 14 | 20 | KLEV115J | 160,00 | KLEV115K | 175,00 |
| MT-09                 | YES         | 13 | 20 | KLEV115J | 160,00 | KLEV115K | 175,00 |
| MT-10                 | YES         | 16 | 20 | KLEV115J | 160,00 | KLEV115K | 175,00 |
| R3                    | NO          | 15 | 20 | KLEV121J | 160,00 | KLEV121K | 175,00 |
| R6                    | YES         | 05 | 16 | KLEV107J | 166,00 | KLEV107K | 181,00 |
| R6                    | YES         | 17 | 20 | KLEV045J | 166,00 | KLEV045K | 181,00 |
| R1                    | YES         | 04 | 14 | KLEV107J | 166,00 | KLEV107K | 181,00 |
| R1 / R1-M             | YES (15-16) | 15 | 20 | KLEV045J | 166,00 | KLEV045K | 181,00 |
| T-MAX 500 - 530 - 560 | NO          | 08 | 20 | KLEV116  | 166,00 | KLEV116K | 181,00 |
| XSR 700               | NO          | 15 | 20 | KLEV115J | 160,00 | KLEV115K | 175,00 |
| XSR 900               | NO          | 13 | 20 | KLEV115J | 160,00 | KLEV115K | 175,00 |







Molla di ritorno  
Recovery spring

Bussola in ERGAL anodizzata rossa  
CNC aluminium bush red-anodized

Colori disponibili: nero / Available colours: black

| Modello - Model | TÜV KBA 91595 | Anno- Year | Codice - Code | € | Codice - Code | € |
|-----------------|---------------|------------|---------------|---|---------------|---|
|-----------------|---------------|------------|---------------|---|---------------|---|



#### BREMBO

|                              |    |   |   |          |       |          |       |
|------------------------------|----|---|---|----------|-------|----------|-------|
| BREMBO (16 x 18) (19 x 18) * | NO | - | - | LEVD502J | 74,00 | LEVD502K | 81,50 |
| BREMBO (19 x 20) *           | NO | - | - | LEVD504J | 74,00 | LEVD504K | 81,50 |

#### APRILIA

|                                   |             |    |    |          |       |          |        |
|-----------------------------------|-------------|----|----|----------|-------|----------|--------|
| RS 660                            | NO          | 20 | 21 | LEVD121J | 98,00 | LEVD121K | 105,50 |
| RSV1000                           | YES         | 04 | 09 | LEVD121J | 98,00 | LEVD121K | 105,50 |
| RSV4 R / RR / RF / Factory / APRC | YES (09-16) | 09 | 20 | LEVD121J | 98,00 | LEVD121K | 105,50 |
| RSV4 1100 Factory                 | NO          | 19 | 20 | LEVD121J | 98,00 | LEVD121K | 105,50 |
| TUONO V4 RR / 1100 Factory        | NO          | 17 | 20 | LEVD121J | 98,00 | LEVD121K | 105,50 |

#### BMW

|          |             |    |    |          |       |          |        |
|----------|-------------|----|----|----------|-------|----------|--------|
| S1000 R  | YES         | 14 | 20 | LEVD126J | 98,00 | LEVD126K | 105,50 |
| S1000 RR | YES (09-18) | 09 | 20 | LEVD126J | 98,00 | LEVD126K | 105,50 |

#### DUCATI

|                          |             |    |    |          |       |          |        |
|--------------------------|-------------|----|----|----------|-------|----------|--------|
| 749 - 999                | YES         | 02 | 06 | LEVD110J | 98,00 | LEVD110K | 105,50 |
| 848 - 1098 - 1198        | YES         | 07 | 11 | LEVD110J | 98,00 | LEVD110K | 105,50 |
| Diavel                   | YES         | 11 | 18 | LEVD110J | 98,00 | LEVD110K | 105,50 |
| Monster 1100             | YES         | 10 | 13 | LEVD110J | 98,00 | LEVD110K | 105,50 |
| Monster 1200             | YES (14-16) | 14 | 20 | LEVD110J | 98,00 | LEVD110K | 105,50 |
| Panigale 899             | YES         | 12 | 16 | LEVD110J | 98,00 | LEVD110K | 105,50 |
| Panigale 959             | YES         | 16 | 20 | LEVD110J | 98,00 | LEVD110K | 105,50 |
| Panigale 1199            | YES         | 12 | 16 | LEVD110J | 98,00 | LEVD110K | 105,50 |
| Panigale 1299            | YES         | 15 | 17 | LEVD110J | 98,00 | LEVD110K | 105,50 |
| Panigale V4 / S          | YES (18-18) | 18 | 20 | LEVD110J | 98,00 | LEVD110K | 105,50 |
| Panigale V2              | NO          | 20 | 20 | LEVD110J | 98,00 | LEVD110K | 105,50 |
| Streetfighter 848 / 1100 | YES         | 09 | 16 | LEVD110J | 98,00 | LEVD110K | 105,50 |
| Streetfighter V4         | NO          | 20 | 20 | LEVD110J | 98,00 | LEVD110K | 105,50 |

#### HONDA

|                  |             |    |    |          |       |          |        |
|------------------|-------------|----|----|----------|-------|----------|--------|
| CB 1000 R        | YES (08-17) | 08 | 20 | LEVD128J | 98,00 | LEVD128K | 105,50 |
| CBR 600 RR       | YES         | 07 | 17 | LEVD128J | 98,00 | LEVD128K | 105,50 |
| CBR 1000 RR      | YES         | 04 | 19 | LEVD128J | 98,00 | LEVD128K | 105,50 |
| CBR 1000 RR-R    | NO          | 20 | 20 | LEVD128J | 98,00 | LEVD128K | 105,50 |
| CBR 1000 RR-R SP | NO          | 20 | 20 | LEVD110J | 98,00 | LEVD110K | 105,50 |

#### ONLY FOR BREMBO MODELS

Per il montaggio sono necessari i componenti originali della leva Brembo  
For the fitment, OEM Brembo components required



\* LEV502



\* LEV504

# LEVE FRENO RIBALTABILE CON REGOLAZIONE DA DESTRA

80 FOLDING BRAKE LEVERS ADJUSTABLE FROM RIGHT

KBA 91595

| Modello - Model  | TÜV KBA 91595 | Anno - Year | Codice - Code | €        | Codice - Code | €               |
|--|---------------|-------------|---------------|----------|---------------|-----------------|
|  |               |             |               |          |               |                 |
| <b>KAWASAKI</b>  |               |             |               |          |               |                 |
| Ninja 250  | NO            | 08          | 13            | LEVD125J | 98,00         | LEVD125K 105,50 |
| Ninja 300  | YES           | 14          | 17            | LEVD125J | 98,00         | LEVD125K 105,50 |
| Ninja 400  | YES           | 18          | 20            | LEVD125J | 98,00         | LEVD125K 105,50 |
| Z 650  | YES (17-19)   | 17          | 20            | LEVD011J | 98,00         | LEVD011K 105,50 |
| Z750   | YES           | 07          | 12            | LEVD011J | 98,00         | LEVD011K 105,50 |
| Z750 R   | YES           | 11          | 12            | LEVD009J | 98,00         | LEVD009K 105,50 |
| Z 800  | YES           | 13          | 16            | LEVD011J | 98,00         | LEVD011K 105,50 |
| Z 900  | YES           | 17          | 20            | LEVD011J | 98,00         | LEVD011K 105,50 |
| Z1000  | YES           | 07          | 16            | LEVD009J | 98,00         | LEVD009K 105,50 |
| Z1000  | NO            | 17          | 20            | LEVD124J | 98,00         | LEVD124K 105,50 |
| Z1000 SX   | YES           | 11          | 16            | LEVD009J | 98,00         | LEVD009K 105,50 |
| Z1000 SX   | NO            | 17          | 20            | LEVD124J | 98,00         | LEVD124K 105,50 |
| ZX6R / ZX 636  | YES (05-16)   | 05          | 20            | LEVD124J | 98,00         | LEVD124K 105,50 |
| ZX10R  | YES           | 06          | 15            | LEVD124J | 98,00         | LEVD124K 105,50 |
| ZX10R  | YES (16-17)   | 16          | 20            | LEVD127J | 98,00         | LEVD127K 105,50 |
| <b>KTM</b>   |               |             |               |          |               |                 |
| DUKE 790   | NO            | 18          | 20            | LEVD132J | 98,00         | LEVD132K 105,50 |
| <b>MV</b>  |               |             |               |          |               |                 |
| F3 675   | YES (12-16)   | 12          | 20            | LEVD123J | 98,00         | LEVD123K 105,50 |
| F3 800   | YES (13-16)   | 13          | 20            | LEVD123J | 98,00         | LEVD123K 105,50 |
| <b>SUZUKI</b>  |               |             |               |          |               |                 |
| GSXR 600 / 750   | YES           | 04          | 17            | LEVD123J | 98,00         | LEVD123K 105,50 |
| GSXR 1000  | YES           | 05          | 20            | LEVD123J | 98,00         | LEVD123K 105,50 |
| GSXS 1000  | YES           | 15          | 20            | LEVD123J | 98,00         | LEVD123K 105,50 |
| <b>TRIUMPH</b>   |               |             |               |          |               |                 |
| Daytona 675  | YES           | 06          | 12            | LEVD009J | 98,00         | LEVD009K 105,50 |
| Daytona 675 R  | YES           | 09          | 16            | LEVD121J | 98,00         | LEVD121K 105,50 |
| Street Triple 675 R  | YES (08-16)   | 08          | 17            | LEVD009J | 98,00         | LEVD009K 105,50 |
| Street Triple 765 R / RS   | NO            | 18          | 20            | LEVD121J | 98,00         | LEVD121K 105,50 |
| Speed Triple 1050 S  | YES           | 08          | 10            | LEVD009J | 98,00         | LEVD009K 105,50 |
| Speed Triple 1050 S / 1050 R   | YES           | 11          | 16            | LEVD121J | 98,00         | LEVD121K 105,50 |
| <b>YAMAHA</b>  |               |             |               |          |               |                 |
| FZ6 / Fazer  | YES           | 04          | 16            | LEVD130J | 98,00         | LEVD130K 105,50 |
| FZ1 / Fazer  | YES           | 06          | 16            | LEVD130J | 98,00         | LEVD130K 105,50 |
| FZ8  | YES           | 10          | 16            | LEVD130J | 98,00         | LEVD130K 105,50 |
| MT-07  | YES (14-16)   | 14          | 20            | LEVD130J | 98,00         | LEVD130K 105,50 |
| MT-09  | YES           | 13          | 20            | LEVD130J | 98,00         | LEVD130K 105,50 |
| MT-10  | YES           | 16          | 20            | LEVD130J | 98,00         | LEVD130K 105,50 |
| R3   | YES (15-16)   | 15          | 20            | LEVD120J | 98,00         | LEVD120K 105,50 |
| R6   | YES           | 05          | 16            | LEVD122J | 98,00         | LEVD122K 105,50 |
| R6   | YES           | 17          | 20            | LEVD118J | 98,00         | LEVD118K 105,50 |
| R1   | YES           | 04          | 14            | LEVD122J | 98,00         | LEVD122K 105,50 |
| R1 / R1-M  | YES (15-16)   | 15          | 20            | LEVD118J | 98,00         | LEVD118K 105,50 |
| T-MAX 500 - 530 - 560 (lato DX)  | NO            | 08          | 20            | LEVD133J | 90,00         | LEVD133K 97,50  |
| T-MAX 500 - 530 - 560 (lato SX)  | NO            | 08          | 20            | LEVD134J | 90,00         | LEVD134K 97,50  |
| XJ6  | YES           | 09          | 16            | LEVD130J | 98,00         | LEVD130K 105,50 |
| XSR 700  | NO            | 15          | 20            | LEVD130J | 98,00         | LEVD130K 105,50 |
| XSR 900  | NO            | 13          | 20            | LEVD130J | 98,00         | LEVD130K 105,50 |



Colori disponibili: nero / Available colours: black

| Modello - Model | TÜV KBA 91595 | Anno- Year | Codice - Code | € | Codice - Code | € |
|-----------------|---------------|------------|---------------|---|---------------|---|
|-----------------|---------------|------------|---------------|---|---------------|---|



NEW!

| <b>APRILIA</b>                    |             |    |    |           |       |           |       |
|-----------------------------------|-------------|----|----|-----------|-------|-----------|-------|
| RS 660                            | NO          | 20 | 21 | LEVXF001J | 75,00 | LEVXF001K | 82,50 |
| RSV1000                           | YES         | 04 | 09 | LEVXF107J | 86,00 | LEVXF107K | 93,50 |
| RSV4 R / RR / RF / Factory / APRC | YES (09-16) | 09 | 20 | LEVXF001J | 75,00 | LEVXF001K | 82,50 |
| RSV4 1100 Factory                 | NO          | 19 | 20 | LEVXF001J | 75,00 | LEVXF001K | 82,50 |
| TUONO V4 / RR / Factory           | YES (11-16) | 11 | 20 | LEVXF001J | 75,00 | LEVXF001K | 82,50 |

| <b>BMW</b>   |     |    |    |           |       |           |       |
|--------------|-----|----|----|-----------|-------|-----------|-------|
| BMW S1000 R  | YES | 14 | 20 | LEVXF015J | 75,00 | LEVXF015K | 82,50 |
| BMW S1000 RR | YES | 09 | 14 | LEVXF008J | 75,00 | LEVXF008K | 82,50 |
| BMW S1000 RR | YES | 15 | 18 | LEVXF015J | 75,00 | LEVXF015K | 82,50 |
| BMW S1000 RR | NO  | 19 | 20 | LEVXF020J | 86,00 | LEVXF020K | 93,50 |

| <b>DUCATI</b>            |             |    |    |           |       |           |       |
|--------------------------|-------------|----|----|-----------|-------|-----------|-------|
| 749 - 999                | YES         | 02 | 06 | LEVXF107J | 86,00 | LEVXF107K | 93,50 |
| 848 - 1098 - 1198        | YES         | 07 | 11 | LEVXF107J | 86,00 | LEVXF107K | 93,50 |
| Diavel                   | YES         | 11 | 16 | LEVXF107J | 86,00 | LEVXF107K | 93,50 |
| Monster S4R              | YES         | 07 | 07 | LEVXF107J | 86,00 | LEVXF107K | 93,50 |
| Monster 1100             | YES         | 10 | 13 | LEVXF107J | 86,00 | LEVXF107K | 93,50 |
| Monster 1200 / R         | YES (14-16) | 14 | 20 | LEVXF107J | 86,00 | LEVXF107K | 93,50 |
| Panigale 899             | YES         | 12 | 16 | LEVXF107J | 86,00 | LEVXF107K | 93,50 |
| Panigale 959             | YES         | 16 | 20 | LEVXF107J | 86,00 | LEVXF107K | 93,50 |
| Panigale 1199            | YES         | 12 | 16 | LEVXF107J | 86,00 | LEVXF107K | 93,50 |
| Panigale 1299            | YES         | 15 | 17 | LEVXF107J | 86,00 | LEVXF107K | 93,50 |
| Panigale V4 / S          | YES (18-18) | 18 | 20 | LEVXF107J | 86,00 | LEVXF107K | 93,50 |
| Panigale V2              | NO          | 20 | 20 | LEVXF107J | 86,00 | LEVXF107K | 93,50 |
| Streetfighter 848 / 1100 | YES         | 09 | 16 | LEVXF107J | 86,00 | LEVXF107K | 93,50 |
| Streetfighter V4         | NO          | 20 | 20 | LEVXF107J | 86,00 | LEVXF107K | 93,50 |

# LEVE FRIZIONE RIBALTABILE PER SNODO ORIGINALE

82 FOLDING CLUTCH LEVERS FOR ORIGINAL JOINT

KBA 91595

Modello - Model      TÜV KBA 91595      Anno- Year      Codice - Code      €      Codice - Code      €



NEW

| <b>HONDA</b>       |     |    |    |           |       |           |       |
|--------------------|-----|----|----|-----------|-------|-----------|-------|
| CB 1000 R          | YES | 08 | 17 | LEVXF003J | 86,00 | LEVXF003K | 93,50 |
| CB 1000 R          | NO  | 18 | 20 | LEVXF002J | 75,00 | LEVXF002K | 82,50 |
| CBR 600 RR         | YES | 03 | 17 | LEVXF002J | 75,00 | LEVXF002K | 82,50 |
| CBR 1000 RR        | YES | 04 | 07 | LEVXF003J | 86,00 | LEVXF003K | 93,50 |
| CBR 1000 RR        | YES | 08 | 19 | LEVXF002J | 75,00 | LEVXF002K | 82,50 |
| CBR 1000 RR-R      | NO  | 20 | 20 | LEVXF002J | 75,00 | LEVXF002K | 82,50 |
| CBR 1000 RR-R / SP | NO  | 20 | 20 | LEVXF002J | 75,00 | LEVXF002K | 82,50 |

| <b>KAWASAKI</b> |             |    |    |           |       |           |       |
|-----------------|-------------|----|----|-----------|-------|-----------|-------|
| Ninja 250       | NO          | 08 | 13 | LEVXF019J | 75,00 | LEVXF019K | 82,50 |
| Ninja 300       | YES         | 14 | 17 | LEVXF019J | 75,00 | LEVXF019K | 82,50 |
| Ninja 400       | YES         | 18 | 20 | LEVXF019J | 75,00 | LEVXF019K | 82,50 |
| Z650            | YES (17-19) | 17 | 20 | LEVXF005J | 75,00 | LEVXF005K | 82,50 |
| Z750            | YES         | 07 | 12 | LEVXF004J | 75,00 | LEVXF004K | 82,50 |
| Z800            | YES         | 13 | 16 | LEVXF004J | 75,00 | LEVXF004K | 82,50 |
| Z900            | YES         | 17 | 20 | LEVXF005J | 75,00 | LEVXF005K | 82,50 |
| Z1000           | YES         | 07 | 16 | LEVXF004J | 75,00 | LEVXF004K | 82,50 |
| Z1000           | NO          | 17 | 20 | LEVXF005J | 75,00 | LEVXF005K | 82,50 |
| Z1000 SX        | YES         | 11 | 16 | LEVXF004J | 75,00 | LEVXF004K | 82,50 |
| ZX6R - 636      | YES (05-16) | 05 | 18 | LEVXF004J | 75,00 | LEVXF004K | 82,50 |
| ZX636           | NO          | 18 | 20 | LEVXF005J | 75,00 | LEVXF005K | 82,50 |
| ZX10R           | YES (06-19) | 06 | 20 | LEVXF004J | 75,00 | LEVXF004K | 82,50 |

| <b>KTM</b> |    |    |    |           |       |           |       |
|------------|----|----|----|-----------|-------|-----------|-------|
| DUKE 790   | NO | 18 | 20 | LEVXF109J | 86,00 | LEVXF109K | 93,50 |

| <b>MV</b> |             |    |    |           |       |           |       |
|-----------|-------------|----|----|-----------|-------|-----------|-------|
| F3 675    | YES (12-16) | 12 | 20 | LEVXF012J | 75,00 | LEVXF012K | 82,50 |
| F3 800    | YES (13-16) | 13 | 20 | LEVXF012J | 75,00 | LEVXF012K | 82,50 |

| <b>SUZUKI</b>  |     |    |    |           |       |           |       |
|----------------|-----|----|----|-----------|-------|-----------|-------|
| GSXR 600 / 750 | YES | 06 | 17 | LEVXF001J | 75,00 | LEVXF001K | 82,50 |
| GSXR 1000      | YES | 05 | 06 | LEVXF001J | 75,00 | LEVXF001K | 82,50 |
| GSXR 1000      | YES | 09 | 20 | LEVXF001J | 75,00 | LEVXF001K | 82,50 |
| GSXS 1000      | YES | 15 | 20 | LEVXF001J | 75,00 | LEVXF001K | 82,50 |

| <b>TRIUMPH</b>              |             |    |    |           |       |           |       |
|-----------------------------|-------------|----|----|-----------|-------|-----------|-------|
| Daytona 675                 | YES         | 06 | 14 | LEVXF018J | 75,00 | LEVXF018K | 82,50 |
| Daytona 675R                | YES         | 11 | 16 | LEVXF018J | 75,00 | LEVXF018K | 82,50 |
| Street Triple 675 R         | YES (08-16) | 08 | 17 | LEVXF018J | 75,00 | LEVXF018K | 82,50 |
| Street Triple 765 R / RS    | NO          | 18 | 20 | LEVXF018J | 75,00 | LEVXF018K | 82,50 |
| Speed Triple 1050 S / 1050R | YES         | 11 | 16 | LEVXF018J | 75,00 | LEVXF018K | 82,50 |

| <b>YAMAHA</b> |             |    |    |           |       |           |       |
|---------------|-------------|----|----|-----------|-------|-----------|-------|
| FZ6 / Fazer   | YES         | 04 | 16 | LEVXF001J | 75,00 | LEVXF001K | 82,50 |
| FZ8           | YES         | 10 | 16 | LEVXF001J | 75,00 | LEVXF001K | 82,50 |
| FZ1 / Fazer   | YES         | 06 | 16 | LEVXF001J | 75,00 | LEVXF001K | 82,50 |
| MT-07         | YES (14-16) | 14 | 20 | LEVXF001J | 75,00 | LEVXF001K | 82,50 |
| MT-09         | YES         | 13 | 20 | LEVXF001J | 75,00 | LEVXF001K | 82,50 |
| MT-10         | YES         | 16 | 20 | LEVXF001J | 75,00 | LEVXF001K | 82,50 |
| R3            | NO          | 15 | 20 | LEVXF021J | 75,00 | LEVXF021K | 82,50 |
| R6            | YES         | 00 | 20 | LEVXF001J | 75,00 | LEVXF001K | 82,50 |
| R1 / R1-M     | YES (00-16) | 00 | 20 | LEVXF001J | 75,00 | LEVXF001K | 82,50 |
| XJ6           | YES         | 09 | 16 | LEVXF001J | 75,00 | LEVXF001K | 82,50 |
| XSR 700       | NO          | 15 | 20 | LEVXF001J | 75,00 | LEVXF001K | 82,50 |
| XSR 900       | NO          | 13 | 20 | LEVXF001J | 75,00 | LEVXF001K | 82,50 |



**NEW LOOK, BEST COMFORT**

Nuova leva frizione ad interasse variabile con leva reclinabile.  
 Nata per un uso prettamente racing consente di variare l'interasse di azionamento.  
 Questa particolarità consente al pilota di poter gestire lo stacco della frizione. Il pilota può perfezionare le partenze, e personalizzare la corsa della leva.

New folding clutch lever with variable wheelbase. Born for a race use, it allows you to vary the drive wheelbase.  
 With this updating, the driver can manage the clutch release, that means that the driver can perfect the starts and customize the lever stroke.



Interassi da 30/32/34 mm.  
 Il sistema di chiusura del bracciale è ancor più veloce, grazie alla fascetta di chiusura con il sistema a cerniera.

Wheelbases from 30/32/34 mm. the closing system of the joint is even faster thanks to the closing strap with the hinge system.

Colori disponibili: nero / Available colours: black

| Modello - Model            | Codice - Code  | €      | Codice - Code   | €      |
|----------------------------|--|--------|---|--------|
| <b>FOR RACING USE ONLY</b> |  |        |  |        |
|                            | LEVXF100J  | 152,00 | LEVXF100K   | 159,50 |

Leva frizione a cavo completa di bracciale ad interasse variabile  
 Cable clutch lever with variable wheelbase



Massimo Roccoli  
 Team Rosso Corsa

## LEVE FRENO RIBALTABILE CON REGOLAZIONE DA SINISTRA

84 FOLDING BRAKE LEVERS ADJUSTABLE FROM LEFT



Colori disponibili: nero / Available colours: black

| Modello - Model                   | TÜV KBA 91595 | Anno- Year | Codice - Code | €        | Codice - Code | €               |
|-----------------------------------|---------------|------------|---------------|----------|---------------|-----------------|
|                                   |               |            |               |          |               |                 |
| <b>BREMBO</b>                     |               |            |               |          |               |                 |
| * BREMBO (16 x 18) (19 x 18)      | NO            | -          | -             | LEVS502J | 130,00        | LEVS502K 137,50 |
| * BREMBO (19 x 20)                | NO            | -          | -             | LEVS504J | 130,00        | LEVS504K 137,50 |
| <b>APRILIA</b>                    |               |            |               |          |               |                 |
| RS 660                            | NO            | 20         | 21            | LEVS121J | 178,00        | LEVS121K 185,50 |
| RSV1000                           | YES           | 04         | 09            | LEVS121J | 178,00        | LEVS121K 185,50 |
| RSV4 R / RR / RF / Factory / APRC | YES (09-16)   | 09         | 20            | LEVS121J | 178,00        | LEVS121K 185,50 |
| RSV4 1100 Factory                 | NO            | 19         | 20            | LEVS121J | 178,00        | LEVS121K 185,50 |
| <b>BMW</b>                        |               |            |               |          |               |                 |
| S1000 RR                          | YES (09-18)   | 09         | 20            | LEVS126J | 178,00        | LEVS126K 185,50 |
| <b>DUCATI</b>                     |               |            |               |          |               |                 |
| 749 - 999                         | YES           | 02         | 06            | LEVS110J | 178,00        | LEVS110K 185,50 |
| 848 - 1098 - 1198                 | YES           | 07         | 11            | LEVS110J | 178,00        | LEVS110K 185,50 |
| Panigale 899                      | YES           | 12         | 16            | LEVS110J | 178,00        | LEVS110K 185,50 |
| Panigale 959                      | YES           | 16         | 20            | LEVS110J | 178,00        | LEVS110K 185,50 |
| Panigale 1199                     | YES           | 12         | 16            | LEVS110J | 178,00        | LEVS110K 185,50 |
| Panigale 1299                     | YES           | 15         | 17            | LEVS110J | 178,00        | LEVS110K 185,50 |
| Panigale V4 / S                   | YES (18-18)   | 18         | 20            | LEVS110J | 178,00        | LEVS110K 185,50 |
| Panigale V2                       | NO            | 20         | 20            | LEVS110J | 178,00        | LEVS110K 185,50 |
| <b>HONDA</b>                      |               |            |               |          |               |                 |
| CBR 600 RR                        | YES           | 07         | 17            | LEVS128J | 178,00        | LEVS128K 185,50 |
| CBR 1000 RR                       | YES           | 04         | 19            | LEVS128J | 178,00        | LEVS128K 185,50 |
| CBR 1000 RR-R                     | NO            | 20         | 20            | LEVS128J | 178,00        | LEVS128K 185,50 |
| CBR 1000 RR-R SP                  | NO            | 20         | 20            | LEVS110J | 178,00        | LEVS110K 185,50 |
| <b>KAWASAKI</b>                   |               |            |               |          |               |                 |
| ZX6R                              | YES (05-16)   | 05         | 20            | LEVS124J | 178,00        | LEVS124K 185,50 |
| ZX10R                             | YES           | 06         | 15            | LEVS124J | 178,00        | LEVS124K 185,50 |
| ZX10R                             | YES (16-17)   | 16         | 20            | LEVS127J | 178,00        | LEVS127K 185,50 |

\* Per il montaggio sono necessari i componenti originali della leva Brembo  
For the fitment, OEM Brembo components required

## LEVE FRENO RIBALTABILE CON REGOLAZIONE DA SINISTRA

FOLDING BRAKE LEVERS ADJUSTABLE FROM LEFT

85

| Modello - Model  | TÜV KBA 91595      | Anno- Year | Codice - Code | €        | Codice - Code | €                      |
|--|--------------------|------------|---------------|----------|---------------|------------------------|
|  |                    |            |               |          |               |                        |
| <b>MV</b>  |                    |            |               |          |               |                        |
| F3 675   | <b>YES (12-16)</b> | 12         | 20            | LEVS123J | <b>178,00</b> | LEVS123K <b>185,50</b> |
| F3 800   | <b>YES (13-16)</b> | 13         | 20            | LEVS123J | <b>178,00</b> | LEVS123K <b>185,50</b> |
| <b>SUZUKI</b>  |                    |            |               |          |               |                        |
| GSXR 600 / 750   | <b>YES</b>         | 04         | 17            | LEVS123J | <b>178,00</b> | LEVS123K <b>185,50</b> |
| GSXR 1000  | <b>YES</b>         | 05         | 20            | LEVS123J | <b>178,00</b> | LEVS123K <b>185,50</b> |
| <b>TRIUMPH</b>   |                    |            |               |          |               |                        |
| Daytona 675  | <b>YES</b>         | 06         | 12            | LEVS009J | <b>178,00</b> | LEVS009K <b>185,50</b> |
| Daytona 675 R  | <b>YES</b>         | 09         | 16            | LEVS121J | <b>178,00</b> | LEVS121K <b>185,50</b> |
| <b>YAMAHA</b>  |                    |            |               |          |               |                        |
| R3   | <b>YES (15-16)</b> | 15         | 20            | LEVS120J | <b>178,00</b> | LEVS120K <b>185,50</b> |
| R6   | <b>YES</b>         | 05         | 16            | LEVS122J | <b>178,00</b> | LEVS122K <b>185,50</b> |
| R6   | <b>YES</b>         | 17         | 20            | LEVS118J | <b>178,00</b> | LEVS118K <b>185,50</b> |
| R1   | <b>YES</b>         | 04         | 14            | LEVS122J | <b>178,00</b> | LEVS122K <b>185,50</b> |
| R1 / R1-M  | <b>YES (15-16)</b> | 15         | 20            | LEVS118J | <b>178,00</b> | LEVS118K <b>185,50</b> |

## KIT INSERTI IN GOMMA PER LEVA "ALIEN"

RUBBER INSERTS KIT FOR "ALIEN" LEVER



**ALIEN**  
GRIP

■ rosso red  
■ blu blue  
■ nero black  
■ bianco white  
■ green verde  
■ arancione orange

| Modello - Model  | Codice - Code | Codice - Code | Codice - Code | Codice - Code | Codice - Code | Codice - Code | €           |
|--|---------------|---------------|---------------|---------------|---------------|---------------|-------------|
|                                  |               |               |               |               |               |               |             |
| Kit inserti in gomma per singola leva "Alien" (una striscia)<br>Rubber inserts kit for one "Alien" lever (one strip) | GM001ROS      | GM001VER      | GM001BLU      | GM001NER      | GM001BIA      | GM001ARA      | <b>4,00</b> |



Leva in magnesio  
Magnesium lever

RLEV001J € 47,00

Colori disponibili: nero / Available colours: black



Leva "Alien" in magnesio con gommini neri  
Magnesium "Alien" lever with black rubber inserts

RLEV001K € 54,50

Colori disponibili: nero / Available colours: black



REGISTRO LEVA FRENO · con supporto  
REMOTE BRAKE ADJUSTER · with mounting clamp

RLEV015 € 88,00



CAVI DI REGOLAZIONE  
CABLES FOR REMOTE ADJUSTER

|        |         |         |
|--------|---------|---------|
| A (M7) | RLEV008 | € 17,00 |
| B      | RLEV014 | € 17,00 |
| C      | RLEV009 | € 17,00 |
| D (M6) | RLEV017 | € 17,00 |

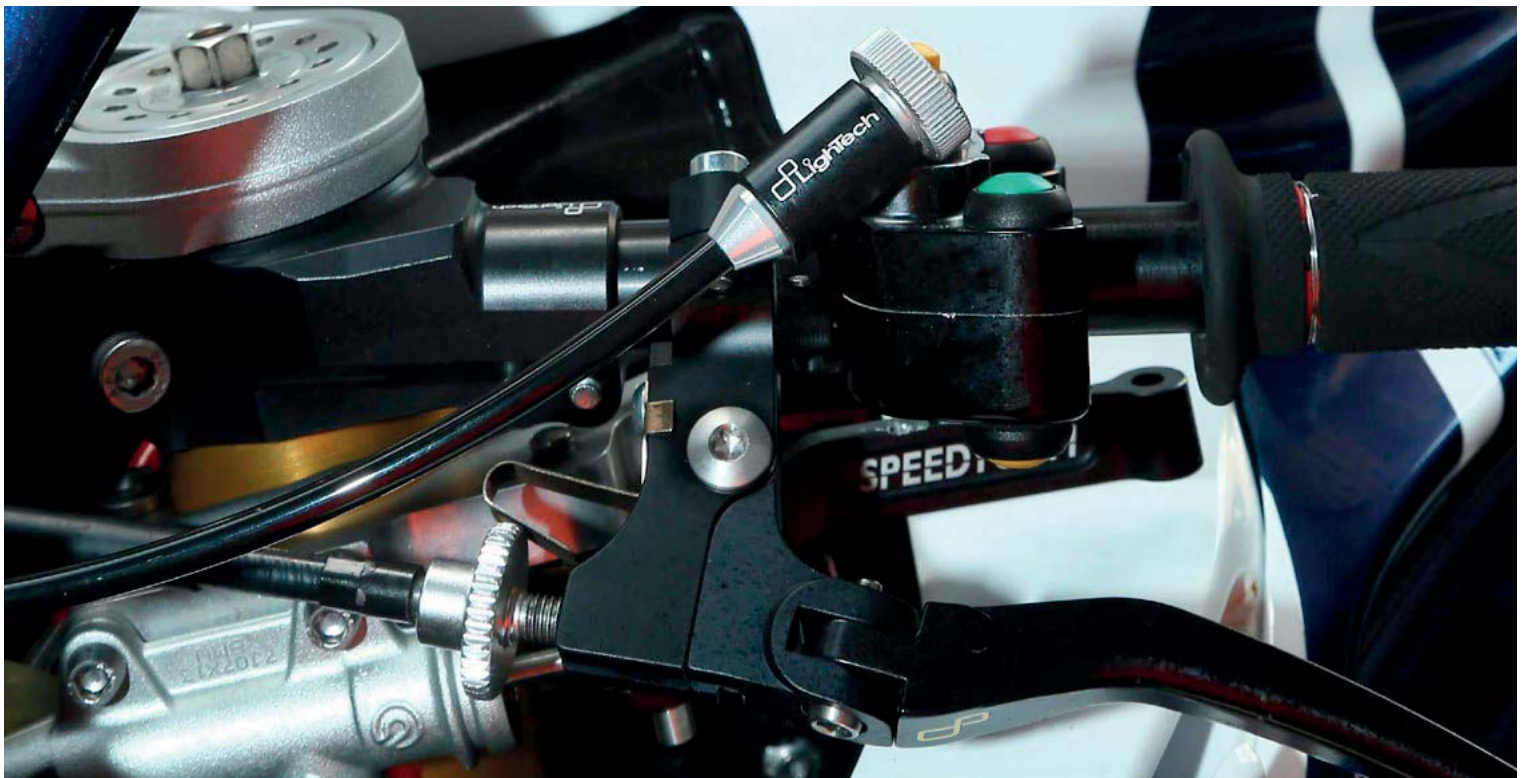





**BRACCIALI MANUBRIO**  
CLIP-ONS

# BRACCIALI MANUBRIO

88 CLIP-ONS

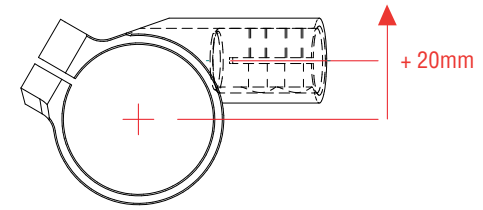

**Bracciali manubrio con offset +20mm**  
Clip-ons with +20mm offset

Colori disponibili: nero. Available colours: black

| Ø      | Altezza - Height | ° Inclinazione gradi - ° Inclination grade | Offset - Offset | Codice - Code | €                          |
|--------|------------------|--|-----------------|---------------|----------------------------|
|        |                  |  |                 |               | <b>a coppia - for pair</b> |
| Ø 41   | +/- 0mm          | 10°  | + 20mm          | MOZ4101       | <b>140,00</b>              |
| Ø 47   | +/- 0mm          | 10°  | + 20mm          | MOZ4701       | <b>140,00</b>              |
| Ø 50   | +/- 0mm          | 10°  | + 20mm          | MOZ5001       | <b>140,00</b>              |
| Ø 51   | +/- 0mm          | 10°  | + 20mm          | MOZ5101       | <b>140,00</b>              |
| Ø 52   | +/- 0mm          | 10°  | + 20mm          | MOZ5201       | <b>140,00</b>              |
| Ø 53   | +/- 0mm          | 10°  | + 20mm          | MOZ5301       | <b>140,00</b>              |
| Ø 54,5 | +/- 0mm          | 10°  | + 20mm          | MOZ5401       | <b>140,00</b>              |
| Ø 55   | +/- 0mm          | 10°  | + 20mm          | MOZ5501       | <b>140,00</b>              |

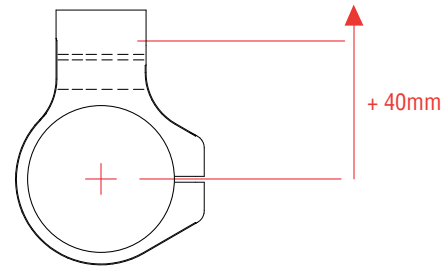

**Bracciali manubrio con offset +40mm**  
Clip-ons with +40mm offset

Colori disponibili: nero. Available colours: black

| Ø      | Altezza - Height | ° Inclinazione gradi - ° Inclination grade | Offset - Offset | Codice - Code | €                          |
|--------|------------------|--|-----------------|---------------|----------------------------|
|        |                  |  |                 |               | <b>a coppia - for pair</b> |
| Ø 47   | +/- 0mm          | 10°  | + 40mm          | MOZ4710       | <b>172,00</b>              |
| Ø 48   | +/- 0mm          | 10°  | + 40mm          | MOZ4810       | <b>172,00</b>              |
| Ø 50   | +/- 0mm          | 10°  | + 40mm          | MOZ5010       | <b>172,00</b>              |
| Ø 51   | +/- 0mm          | 5°   | + 40mm          | MOZ5110       | <b>172,00</b>              |
| Ø 52   | +/- 0mm          | 5°   | + 40mm          | MOZ5210       | <b>172,00</b>              |
| Ø 53   | +/- 0mm          | 10°  | + 40mm          | MOZ5310       | <b>172,00</b>              |
| Ø 54,5 | +/- 0mm          | 10°  | + 40mm          | MOZ5410       | <b>172,00</b>              |
| Ø 55   | +/- 0mm          | 5°   | + 40mm          | MOZ5510       | <b>172,00</b>              |

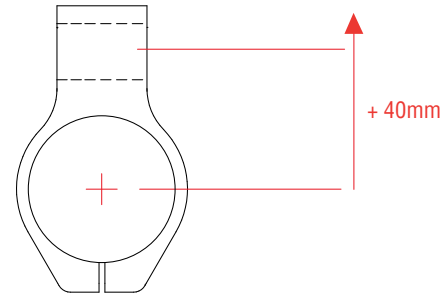

**Bracciali manubrio con offset +40mm**  
Clip-ons with +40mm offset

Colori disponibili: nero. Available colours: black

| Ø    | Altezza - Height | ° Inclinazione gradi - ° Inclination grade | Offset - Offset | Codice - Code | €                   |
|------|------------------|--|-----------------|---------------|---------------------|
|      |                  |  |                 |               |                     |
|      |                  |  |                 |               | a coppia - for pair |
| Ø 47 | +20mm            | 10°  | + 40mm          | MOZ4720       | <b>182,00</b>       |
| Ø 48 | +20mm            | 10°  | + 40mm          | MOZ4820       | <b>182,00</b>       |
| Ø 50 | +20mm            | 10°  | + 40mm          | MOZ5020       | <b>182,00</b>       |
| Ø 55 | +20mm            | 5°   | + 40mm          | MOZ5520       | <b>182,00</b>       |

APPLICAZIONI MOZZETTI - CLIP-ONS APPLICATION LIST

Anno - Years

diametro - diameter

| Model            | Year                     | Year                | Diameter | Notes |                 |
|------------------|--------------------------|---------------------|----------|-------|-----------------|
| <b>APRILIA</b>   | RS 660                   | 20                  | 21       | 51    |                 |
|                  | RSV 1000                 | 00                  | 05       | 51    |                 |
|                  | RSV 1000 / Factory       | 06                  | 09       | 50    | Ohlins e K-Tech |
|                  | RSV4 R / RR              | 09                  | 20       | 50    |                 |
|                  | RSV4 Factory / APRC / RF | 09                  | 18       | 51    | Ohlins          |
|                  | RSV4 1100 Factory        | 19                  | 20       | 51    | Ohlins          |
| <b>BMW</b>       | S 1000 RR                | 09                  | 20       | 55    |                 |
|                  | <b>DUCATI</b>            | 748-749-916-998-999 | 94       | 06    | 53              |
| <b>HONDA</b>     | 848 / 1098 / 1198        | 07                  | 11       | 53    |                 |
|                  | PANIGALE V4              | 18                  | 20       | 53    |                 |
|                  | CBR 600 RR               | 07                  | 16       | 48    |                 |
| <b>KAWASAKI</b>  | CBR 1000 RR              | 04                  | 19       | 50    |                 |
|                  | CBR 1000 RR-R / SP       | 20                  | 20       | 50    |                 |
|                  | ZX 400                   | 18                  | 20       | 41    |                 |
| <b>MV AGUSTA</b> | ZX 6 R                   | 03                  | 08       | 50    |                 |
|                  | ZX 6 R                   | 09                  | 17       | 51    |                 |
|                  | ZX 636                   | 09                  | 20       | 50    |                 |
|                  | ZX 10 R                  | 04                  | 20       | 50    |                 |
|                  | F3 675 / 800             | 12                  | 16       | 50    |                 |
| <b>SUZUKI</b>    | GSXR 600 / 750           | 06                  | 07       | 48    |                 |
|                  | GSXR 600 / 750           | 08                  | 17       | 50    |                 |
|                  | GSXR 1000                | 05                  | 20       | 50    |                 |
| <b>TRIUMPH</b>   | DAYTONA 675 / 675 R      | 07                  | 18       | 50    |                 |
|                  | DAYTONA 765              | 19                  | 20       | 50    |                 |
| <b>YAMAHA</b>    | R3                       | 16                  | 18       | 41    |                 |
|                  | R3                       | 19                  | 20       | 47    |                 |
|                  | R6                       | 06                  | 20       | 50    |                 |
|                  | R1                       | 04                  | 20       | 50    |                 |



# BRACCIALI MANUBRIO

90 CLIP-ONS



| SEMIMANUBRIO - HANDLEBAR TUBES   | Codice - Code | €                   |
|--|---------------|---------------------|
|  |               | a coppia - for pair |
| lunghezza 270 mm - length 270 mm<br>foro interno Ø 16,5 mm - internal hole Ø 16.5 mm | HBT004        | <b>44,00</b>        |



|   |           |                |
|---|-----------|----------------|
| Bracciali per piastra di sterzo BMW S1000RR 19 - 20 | TCB001NER | <b>€ 64,00</b> |
| Triple clamp bracelets for BMW S1000RR 19 - 20      |           |                |

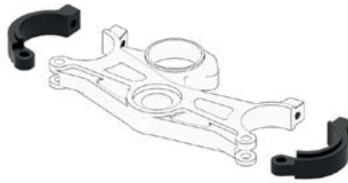

|                                      |           |   |
|--------------------------------------|-----------|---|
| Piastra di sterzo per Aprilia RS 660 | TCA001NER | € |
| Triple Clamp for Aprilia RS 660      |           |   |

A close-up photograph of a motorcycle lever guard. The guard is primarily red with a black mounting bracket. It features a white, stylized logo on its side. The background is a blurred red surface, likely part of the motorcycle's bodywork. In the upper right corner, there is a black rectangular box containing white text.

**PROTEZIONI LEVE**  
LEVERS  
GUARDS

# PROTEZIONI LEVE



**ATTENZIONE!**

• Ricorda che l'adattatore è assolutamente necessario per poter applicare la protezione leva.

**WARNING!**

• The adaptor is absolutely necessary to install the lever protection.

**100%  
Made in Italy**



Protezione leva  
Lever guard

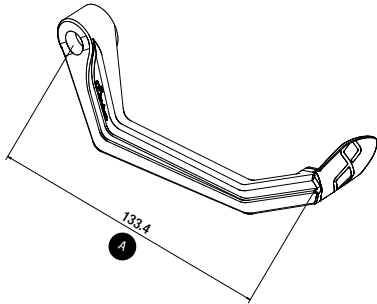

Verifica sempre la misura  
Always check the measurement

- verde / green
- oro / gold
- rosso / red
- nero / black
- silver / silver
- cobalto / cobalt
- arancione / orange

| Descrizione - Description   | A | Codice - Code | €        |                                    |               |
|---|---|---------------|----------|------------------------------------|---------------|
| <b>a pezzo - for piece</b>  |   |               |          |                                    |               |
| <b>PROTEZIONI LEVE in alluminio (corpo + terminale, escluso adattatore) / Aluminium lever guards kit (body + guard end, adaptor not included)</b> |   |               |          |                                    |               |
| Protezione leva freno / Brake lever guard   | R | 132 mm        | ISS113RA | (corpo+terminale / body+guard end) | <b>106,00</b> |
| Protezione leva freno / Brake lever guard   | R | 148 mm        | ISS120RA | (corpo+terminale / body+guard end) | <b>106,00</b> |
| Protezione leva frizione / Clutch lever guard   | L | 132 mm        | ISS119LA | (corpo+terminale / body+guard end) | <b>106,00</b> |
| Protezione leva frizione / Clutch lever guard   | L | 148 mm        | ISS114LA | (corpo+terminale / body+guard end) | <b>106,00</b> |





| Descrizione - Description   | A | Codice - Code                                      | €             |
|---|---|--|---------------|
| <b>a pezzo - for piece</b>  |   |  |               |
| <b>PROTEZIONI LEVE in carbonio (corpo + terminale, escluso adattatore) / Carbon lever guards kit (body + guard end, adaptor not included)</b> |   |  |               |
| Protezione leva freno / brake lever guard   | R | 132 mm ISS115RC (corpo+terminale / body+guard end) | <b>153,00</b> |
| Protezione leva frizione / clutch lever guard   | L | 132 mm ISS116LC (corpo+terminale / body+guard end) | <b>153,00</b> |

**RICAMBI PER PROTEZIONI LEVA**  
SPARE PARTS FOR LEVERS GUARD

Colori disponibili - Available colours:



verde green    oro gold    rosso red    nero black    silver silver    cobalto cobalt    arancione orange

| Descrizione - Description  | A | Codice - Code | €            |
|----------------------------|---|---------------|--------------|
| <b>a pezzo - for piece</b> |   |               |              |
| Terminale R / Guard end R  | R | ISS117        | <b>39,50</b> |
| Terminale L / Guard end L  | L | ISS118        | <b>39,50</b> |

# ADATTATORI PROTEZIONI LEVE

## 94 ADAPTORS KITS FOR LEVER GUARDS



**Attenzione!** L'adattatore è assolutamente necessario per poter applicare la protezione leva.

**Warning!** The adaptor is absolutely necessary in order to apply the lever guard.

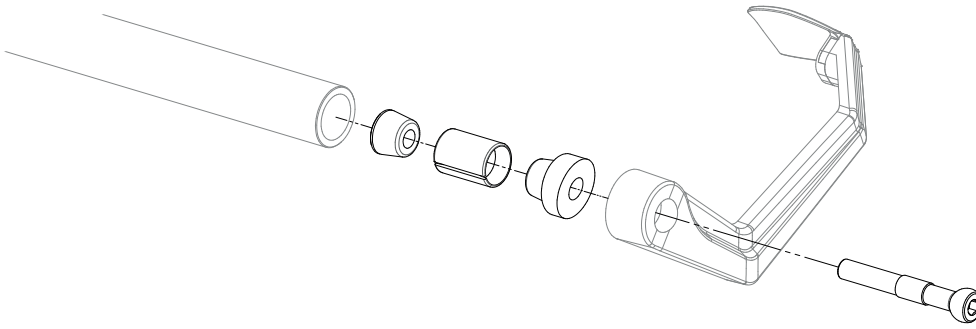

| Descrizione - Description  | Anno - Year | Ø | Codice - Code | €      | a pezzo - for piece |
|--|-------------|---|---------------|--------|---------------------|
| adattatori universali / universal adaptors                       |             |   | 14/15,5       | KPL329 | 24,00               |
| adattatori universali per HBT004 / universal adaptors for HBT004 |             |   | 16/17,5       | KPL302 | 24,00               |
| adattatori universali / universal adaptors                       |             |   | 18/19,5       | KPL319 | 24,00               |

NEW!

| APRILIA                 |    |    |  |        |       |
|-------------------------|----|----|--|--------|-------|
| RS 660                  | 20 | 21 |  | KPL331 | 24,00 |
| RSV4 (all versions)     | 09 | 20 |  | KPL303 | 24,00 |
| RSV1000                 | 04 | 08 |  | KPL313 | 24,00 |
| Shiver 750              | 07 | 15 |  | KPL313 | 24,00 |
| Tuono                   | 06 | 09 |  | KPL313 | 24,00 |
| Tuono V4 / 1100 Factory | 11 | 20 |  | KPL313 | 24,00 |

| BMW                                       |    |    |  |        |       |
|---|----|----|--|--------|-------|
| R Nine-T Scrambler / Urban / Racer / Pure | 16 | 16 |  | KPL325 | 24,00 |
| S1000R                                    | 14 | 20 |  | KPL325 | 24,00 |
| S1000RR                                   | 09 | 18 |  | KPL325 | 24,00 |
| S1000RR                                   | 19 | 20 |  | KPL330 | 24,00 |

| DUCATI                     |    |    |         |        |       |
|----------------------------|----|----|---------|--------|-------|
| 1098 / 1198                | 07 | 11 | 16/17,5 | KPL302 | 24,00 |
| Monster S4 - ST2           | 07 | 07 |         | KPL304 | 24,00 |
| Monster 821                | 14 | 16 | 17      | KPL302 | 24,00 |
| Monster 1100               | 11 | 13 | 14,5    | KPL322 | 24,00 |
| Panigale 899 / 1199 / 1299 | 12 | 17 |         | KPL318 | 24,00 |
| Panigale 959               | 16 | 20 |         | KPL318 | 24,00 |
| Panigale V4                | 18 | 20 | 18      | KPL319 | 24,00 |
| Panigale V2                | 20 | 20 |         | KPL318 | 24,00 |
| Streetfighter 848 / 1100   | 08 | 16 | 14,5    | KPL322 | 24,00 |
| Streetfighter V4           | 20 | 20 | 14,5    | KPL322 | 24,00 |

| HONDA       |     |     |  |        |       |
|-------------|-----|-----|--|--------|-------|
| tutte / all | ... | ... |  | KPL306 | 24,00 |

| KAWASAKI              |    |    |  |        |       |
|-----------------------|----|----|--|--------|-------|
| ER-6N                 | 12 | 15 |  | KPL304 | 24,00 |
| Ninja 250 / Ninja 400 | 18 | 20 |  | KPL304 | 24,00 |
| Z750                  | 04 | 12 |  | KPL304 | 24,00 |
| Z650                  | 17 | 20 |  | KPL319 | 24,00 |
| Z800                  | 13 | 16 |  | KPL304 | 24,00 |



| Descrizione - Description         | Anno - Year |    | Ø       | Codice - Code | €                                  |
|-----------------------------------|-------------|----|---------|---------------|------------------------------------|
|                                   |             |    |         |               | <small>a pezzo - for piece</small> |
| <b>KAWASAKI</b>                   |             |    |         |               |                                    |
| Z900                              | 17          | 20 |         | KPL304        | <b>24,00</b>                       |
| Z1000                             | 03          | 16 |         | KPL304        | <b>24,00</b>                       |
| Z1000 SX                          | 11          | 16 |         | KPL304        | <b>24,00</b>                       |
| ZX250R                            | 09          | 12 |         | KPL304        | <b>24,00</b>                       |
| ZX6R / 636                        | 03          | 20 |         | KPL304        | <b>24,00</b>                       |
| ZX10R                             | 11          | 20 |         | KPL304        | <b>24,00</b>                       |
| <b>KTM</b>                        |             |    |         |               |                                    |
| Duke 125 / 390                    | 17          | 20 |         | KPL311        | <b>24,00</b>                       |
| Duke 790                          | 18          | 20 |         | KPL329        | <b>24,00</b>                       |
| Duke 890 R                        | 20          | 20 |         | KPL329        | <b>24,00</b>                       |
| Duke 1290 R                       | 20          | 20 |         | KPL329        | <b>24,00</b>                       |
| <b>MV</b>                         |             |    |         |               |                                    |
| BRUTALE 4 cilindri (all versions) | 10          | 17 | 16/17,5 | KPL302        | <b>24,00</b>                       |
| B3 675 / 800                      | 12          | 17 |         | KPL320        | <b>24,00</b>                       |
| F3 675 / 800                      | 11          | 17 | 18/19,5 | KPL319        | <b>24,00</b>                       |
| F4 (all versions)                 | 10          | 17 | 18/19,5 | KPL323        | <b>24,00</b>                       |
| <b>SUZUKI</b>                     |             |    |         |               |                                    |
| Gladius 650                       | 09          | 15 |         | KPL309        | <b>24,00</b>                       |
| GSR 600                           | 06          | 11 |         | KPL305        | <b>24,00</b>                       |
| GSR 750                           | 11          | 16 |         | KPL305        | <b>24,00</b>                       |
| GSXR 600 / 750                    | 00          | 05 |         | KPL305        | <b>24,00</b>                       |
| GSXR 600 / 750                    | 06          | 17 |         | KPL309        | <b>24,00</b>                       |
| GSXR 1000                         | 03          | 04 |         | KPL305        | <b>24,00</b>                       |
| GSXR 1000                         | 05          | 16 |         | KPL309        | <b>24,00</b>                       |
| GSXR 1000                         | 17          | 20 |         | KPL327        | <b>24,00</b>                       |
| GSXS 750                          | 17          | 20 |         | KPL328        | <b>24,00</b>                       |
| GSXS 1000                         | 15          | 20 |         | KPL302        | <b>24,00</b>                       |
| <b>TRIUMPH</b>                    |             |    |         |               |                                    |
| STREET TRIPLE 675 R               | 07          | 12 |         | KPL302        | <b>24,00</b>                       |
| STREET TRIPLE 675 R               | 13          | 16 |         | KPL311        | <b>24,00</b>                       |
| STREET TRIPLE 765 R / S / RS      | 17          | 20 |         | KPL311        | <b>24,00</b>                       |
| <b>YAMAHA</b>                     |             |    |         |               |                                    |
| Fazer 600 - FZ6                   | 04          | 06 |         | KPL310        | <b>24,00</b>                       |
| Fazer 1000                        | 01          | 12 |         | KPL310        | <b>24,00</b>                       |
| MT-07                             | 14          | 20 |         | KPL310        | <b>24,00</b>                       |
| MT-09                             | 13          | 20 |         | KPL310        | <b>24,00</b>                       |
| MT-10                             | 16          | 20 |         | KPL310        | <b>24,00</b>                       |
| R 125                             | 08          | 17 |         | KPL310        | <b>24,00</b>                       |
| R1 / R1M                          | 98          | 20 |         | KPL311        | <b>24,00</b>                       |
| R3                                | 15          | 20 |         | KPL311        | <b>24,00</b>                       |
| R6                                | 06          | 20 |         | KPL311        | <b>24,00</b>                       |
| T Max 500 - 530 - 560             | 02          | 20 |         | KPL310        | <b>24,00</b>                       |
| X-MAX 400                         | 13          | 19 |         | KPL310        | <b>24,00</b>                       |

BORN  
TO BE  
MOTO





**CONTRAPPESI**  
**MANUBRIO**  
HANDLEBAR  
BALANCERS

# CONTRAPPESI MANUBRIO

## NEW DESIGN, SMART PLUG

Ottimizzazione degli stock grazie all'intercambiabilità del **CAP001** tra KTM serie 400 e **SCV001-002** (vedi pag. 72).

Stock optimization thanks to the interchangeability of the **CAP001** between KTM 400 series and **SCV001-002** (see page 72).

### KTM 400 series

Nuovi contrappesi manubrio  
New handlebar balancers



### CAP001

Disponibili in tutte le combinazioni colore  
Available in all color combinations

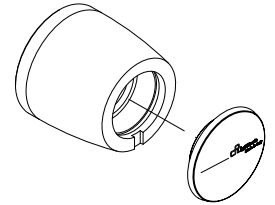

a kit - for kit

Kit tappi colorati per KTM 400 serie  
Colored caps kit for KTM 400 series

CAP001

€ 11,00

### KTM 400 series

Colori disponibili: nero/ Available colours: black

| Descrizione - Description                   | Anno - Year |         | Misura - measure | Codice - Code | €     |
|---|-------------|---------|------------------|---------------|-------|
|   | dal - from  | al - to |                  |               |       |
| Universali / Universal                      |             |         | d.12/13/17       | KTM400        | 27,00 |
| <b>APRILIA</b>                              |             |         |                  |               |       |
| RS 660                                      | 20          | 21      |                  | KTM431        | 24,00 |
| RSV4 (all versions)                         | 09          | 20      |                  | KTM403        | 24,00 |
| <b>BMW</b>                                  |             |         |                  |               |       |
| R Nine-T / Scrambler / Pure / Urban / Racer | 16          | 19      |                  | KTM425        | 24,00 |
| S1000R                                      | 14          | 20      |                  | KTM425        | 24,00 |
| S1000RR                                     | 09          | 18      |                  | KTM425        | 24,00 |
| S1000RR                                     | 19          | 20      |                  | KTM430        | 24,00 |
| <b>DUCATI</b>                               |             |         |                  |               |       |
| Diavel                                      | 11          | 18      | d.12             | KTM400        | 27,00 |
| Monster 821                                 | 14          | 20      | d.17             | KTM400        | 27,00 |
| Monster 1200 S / R                          | 17          | 20      |                  | KTM400        | 27,00 |
| Multistrada                                 | 03          | 09      |                  | KTM405        | 24,00 |
| Panigale 899 / 1199 / 1299                  | 12          | 17      |                  | KTM418        | 24,00 |
| Panigale 959                                | 16          | 20      |                  | KTM418        | 24,00 |
| Panigale V2                                 | 20          | 20      |                  | KTM418        | 24,00 |
| Panigale V4                                 | 18          | 20      |                  | KTM429        | 24,00 |
| Streetfighter V4 / S                        | 20          | 20      |                  | KTM422        | 24,00 |
| 848   | 08          | 11      | d.12             | KTM400        | 27,00 |
| 1098 / 1198                                 | 07          | 11      | d.17             | KTM400        | 27,00 |
| <b>HONDA</b>                                |             |         |                  |               |       |
| tutte / all                                 | ..          | ..      |                  | KTM406        | 24,00 |

NEW!

| Descrizione - Description    | Anno - Year |         | Misura - measure | Codice - Code | €                   |
|------------------------------|-------------|---------|------------------|---------------|---------------------|
|                              | dal - from  | al - to |                  |               | a coppia - for pair |
| <b>KAWASAKI</b>              |             |         |                  |               |                     |
| ER-6N                        | 12          | 16      |                  | KTM404        | 24,00               |
| Ninja 250 / Ninja 400        | 18          | 20      |                  | KTM404        | 24,00               |
| Z125                         | 19          | 20      |                  | KTM404        | 24,00               |
| Z400                         | 17          | 20      |                  | KTM404        | 24,00               |
| Z650                         | 17          | 20      |                  | KTM426        | 24,00               |
| Z750                         | 04          | 12      |                  | KTM404        | 24,00               |
| Z800                         | 13          | 16      |                  | KTM407        | 24,00               |
| Z900                         | 17          | 20      |                  | KTM404        | 24,00               |
| Z1000                        | 03          | 16      |                  | KTM404        | 24,00               |
| Z1000 SX                     | 11          | 16      |                  | KTM404        | 24,00               |
| ZX250R                       | 09          | 12      |                  | KTM407        | 24,00               |
| ZX6R / 636                   | 03          | 20      |                  | KTM404        | 24,00               |
| ZX10R                        | 11          | 15      |                  | KTM404        | 24,00               |
| ZX10R                        | 16          | 20      |                  | KTM407        | 24,00               |
| <b>KTM</b>                   |             |         |                  |               |                     |
| Duke 390                     | 17          | 20      |                  | KTM411        | 24,00               |
| Duke 790                     | 18          | 20      |                  | KTM400        | 27,00               |
| Duke 890 R                   | 20          | 20      |                  | KTM400        | 27,00               |
| Duke 1290R                   | 20          | 20      |                  | KTM400        | 27,00               |
| <b>SUZUKI</b>                |             |         |                  |               |                     |
| Gladius 650                  | 09          | 15      |                  | KTM409        | 24,00               |
| GSR 600                      | 06          | 11      |                  | KTM405        | 24,00               |
| GSR 750                      | 11          | 16      |                  | KTM405        | 24,00               |
| GSXR 600 / 750               | 00          | 05      |                  | KTM405        | 24,00               |
| GSXR 600 / 750               | 06          | 16      |                  | KTM409        | 24,00               |
| GSXR 1000                    | 03          | 04      |                  | KTM405        | 24,00               |
| GSXR 1000                    | 05          | 16      |                  | KTM409        | 24,00               |
| GSXR 1000                    | 17          | 20      |                  | KTM427        | 28,00               |
| GSXR 750                     | 17          | 20      |                  | KTM428        | 24,00               |
| GSXR 1000                    | 15          | 20      |                  | KTM400        | 24,00               |
| <b>TRIUMPH</b>               |             |         |                  |               |                     |
| STREET TRIPLE 675            | 07          | 12      |                  | KTM400        | 27,00               |
| STREET TRIPLE 675 R          | 13          | 16      |                  | KTM411        | 24,00               |
| STREET TRIPLE 765 R / S / RS | 17          | 20      |                  | KTM411        | 24,00               |
| <b>YAMAHA</b>                |             |         |                  |               |                     |
| Fazer 600 - FZ6              | 04          | 06      |                  | KTM410        | 24,00               |
| FZ1                          | 06          | 11      |                  | KTM411        | 24,00               |
| Fazer 1000                   | 01          | 12      |                  | KTM410        | 24,00               |
| MT-07 / XSR-700              | 14          | 20      |                  | KTM410        | 24,00               |
| MT-09                        | 13          | 20      |                  | KTM410        | 24,00               |
| MT-10                        | 16          | 20      |                  | KTM410        | 24,00               |
| R 125                        | 08          | 13      |                  | KTM410        | 24,00               |
| R1 / R1M                     | 98          | 20      |                  | KTM411        | 24,00               |
| R3                           | 15          | 20      |                  | KTM411        | 24,00               |
| R6                           | 06          | 20      |                  | KTM411        | 24,00               |
| T Max 500 - 530 - 560        | 02          | 20      |                  | KTM410        | 24,00               |
| X-MAX 400                    | 13          | 19      |                  | KTM410        | 24,00               |



# CONTRAPPESI MANUBRIO

## 100 HANDLEBAR BALANCERS

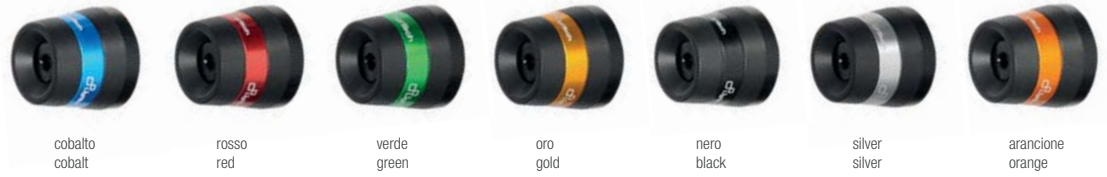

| Modello - Model | Anno - Year | Misura - measure | Combinazione colore - Color combinations | Codice - Code | € |
|-----------------|-------------|------------------|--|---------------|---|
|-----------------|-------------|------------------|--|---------------|---|

| dal - from |  | al - to |  | a coppia - for pair |  |
|------------|--|---------|--|---------------------|--|
|------------|--|---------|--|---------------------|--|

|                        |  |  |            |  |        |              |
|------------------------|--|--|------------|--|--------|--------------|
| Universali / Universal |  |  | d.12/13/17 |  | KTM300 | <b>38,00</b> |
|------------------------|--|--|------------|--|--------|--------------|

| <b>APRILIA</b>      |    |    |  |  |        |              |
|---------------------|----|----|--|--|--------|--------------|
| RSV4 (all versions) | 09 | 20 |  |  | KTM303 | <b>36,50</b> |
| RSV1000             | 04 | 08 |  |  | KTM313 | <b>36,50</b> |
| Shiver 750          | 07 | 16 |  |  | KTM313 | <b>36,50</b> |
| Tuono               | 06 | 09 |  |  | KTM313 | <b>36,50</b> |
| Tuono V4            | 11 | 20 |  |  | KTM313 | <b>36,50</b> |

| <b>BMW</b>                                  |    |    |  |  |        |              |
|---|----|----|--|--|--------|--------------|
| R Nine-T / Scrambler / Pure / Urban / Racer | 16 | 19 |  |  | KTM325 | <b>36,50</b> |
| S1000R                                      | 14 | 20 |  |  | KTM325 | <b>36,50</b> |
| S1000RR                                     | 09 | 18 |  |  | KTM325 | <b>36,50</b> |
| S1000RR                                     | 19 | 20 |  |  | KTM330 | <b>36,50</b> |

| <b>DUCATI</b>              |    |    |        |  |        |              |
|----------------------------|----|----|--------|--|--------|--------------|
| Diavel                     | 11 | 18 | d.12   |  | KTM300 | <b>38,00</b> |
| Monster 821                | 14 | 20 | d.17   |  | KTM300 | <b>38,00</b> |
| Monster 1100               | 11 | 13 | d.14,5 |  | KTM322 | <b>36,50</b> |
| Monster 1200 S / R         | 17 | 20 |        |  | KTM300 | <b>38,00</b> |
| Multistrada                | 03 | 09 |        |  | KTM305 | <b>36,50</b> |
| Panigale 899 / 1199 / 1299 | 12 | 17 |        |  | KTM318 | <b>36,50</b> |
| Panigale 959               | 16 | 20 |        |  | KTM318 | <b>36,50</b> |
| Panigale V2                | 20 | 20 |        |  | KTM318 | <b>36,50</b> |
| Panigale V4                | 18 | 20 |        |  | KTM329 | <b>36,50</b> |
| Streetfighter 848 / 1100   | 08 | 16 | d.14,5 |  | KTM322 | <b>36,50</b> |
| Streetfighter V4 / S       | 20 | 20 | d.14,5 |  | KTM322 | <b>36,50</b> |
| 848                        | 08 | 11 | d.12   |  | KTM300 | <b>38,00</b> |
| 1098 / 1198                | 07 | 11 | d.17   |  | KTM300 | <b>38,00</b> |

| <b>HONDA</b> |     |     |  |  |        |              |
|--------------|-----|-----|--|--|--------|--------------|
| tutte / all  | ... | ... |  |  | KTM306 | <b>36,50</b> |

| <b>KAWASAKI</b>       |    |    |  |  |        |              |
|-----------------------|----|----|--|--|--------|--------------|
| ER-6N                 | 12 | 16 |  |  | KTM304 | <b>36,50</b> |
| Ninja 250 / Ninja 400 | 18 | 20 |  |  | KTM304 | <b>36,50</b> |
| Z125                  | 19 | 20 |  |  | KTM304 | <b>36,50</b> |
| Z400                  | 17 | 20 |  |  | KTM304 | <b>36,50</b> |
| Z650                  | 17 | 20 |  |  | KTM326 | <b>38,00</b> |
| Z750                  | 04 | 12 |  |  | KTM304 | <b>36,50</b> |
| Z800                  | 13 | 16 |  |  | KTM307 | <b>36,50</b> |
| Z900                  | 17 | 20 |  |  | KTM304 | <b>36,50</b> |
| Z1000                 | 03 | 16 |  |  | KTM304 | <b>36,50</b> |
| Z1000 SX              | 11 | 16 |  |  | KTM304 | <b>36,50</b> |
| ZX250R                | 09 | 12 |  |  | KTM307 | <b>36,50</b> |
| ZX6R / 636            | 03 | 20 |  |  | KTM304 | <b>36,50</b> |
| ZX10R                 | 11 | 15 |  |  | KTM304 | <b>36,50</b> |
| ZX10R                 | 16 | 20 |  |  | KTM307 | <b>36,50</b> |

| Modello - Model                   | Anno - Year |         | Misura - measure | Combinazione colore - Color combination | Codice - Code | €     |
|-----------------------------------|-------------|---------|------------------|---|---------------|-------|
|                                   | dal - from  | al - to |                  |   |               |       |
| <b>KTM</b>                        |             |         |                  |   |               |       |
| Duke 390                          | 17          | 20      |                  |   | KTM311        | 36,50 |
| Duke 790                          | 18          | 20      |                  |   | KTM300        | 38,00 |
| Duke 890 R                        | 20          | 20      |                  |   | KTM300        | 38,00 |
| Duke 1290R                        | 20          | 20      |                  |   | KTM300        | 38,00 |
| <b>MV</b>                         |             |         |                  |   |               |       |
| BRUTALE - 4 cilindri tutte / all  | 01          | 17      |                  |   | KTM320        | 36,50 |
| Brutale B3 - 3 cilindri 675 / 800 | 12          | 17      |                  |   | KTM320        | 36,50 |
| F3 675 / 800                      | 11          | 17      |                  |   | KTM319        | 36,50 |
| F4 tutte / all                    | 10          | 17      |                  |   | KTM323        | 36,50 |
| <b>SUZUKI</b>                     |             |         |                  |   |               |       |
| Gladius 650                       | 09          | 15      |                  |   | KTM309        | 36,50 |
| GSR 600                           | 06          | 11      |                  |   | KTM305        | 36,50 |
| GSR 750                           | 11          | 16      |                  |   | KTM305        | 36,50 |
| GSXR 600 / 750                    | 00          | 05      |                  |   | KTM305        | 36,50 |
| GSXR 600 / 750                    | 06          | 16      |                  |   | KTM309        | 36,50 |
| GSXR 1000                         | 03          | 04      |                  |   | KTM305        | 36,50 |
| GSXR 1000                         | 05          | 16      |                  |   | KTM309        | 36,50 |
| GSXR 1000                         | 17          | 20      |                  |   | KTM327        | 40,50 |
| GSXS 750                          | 17          | 20      |                  |   | KTM328        | 38,00 |
| GSXS 1000                         | 15          | 20      |                  |   | KTM300        | 38,00 |
| <b>TRIUMPH</b>                    |             |         |                  |   |               |       |
| STREET TRIPLE 675                 | 07          | 12      |                  |   | KTM300        | 38,00 |
| STREET TRIPLE 675 R               | 13          | 16      |                  |   | KTM311        | 36,50 |
| STREET TRIPLE 765 R / S / RS      | 17          | 20      |                  |   | KTM311        | 36,50 |
| <b>YAMAHA</b>                     |             |         |                  |   |               |       |
| Fazer 600 - FZ6                   | 04          | 06      |                  |   | KTM310        | 36,50 |
| FZ1                               | 06          | 11      |                  |   | KTM311        | 36,50 |
| Fazer 1000                        | 01          | 12      |                  |   | KTM310        | 36,50 |
| MT-07 / XSR-700                   | 14          | 20      |                  |   | KTM310        | 36,50 |
| MT-09                             | 13          | 20      |                  |   | KTM310        | 36,50 |
| MT-10                             | 16          | 20      |                  |   | KTM310        | 36,50 |
| R 125                             | 08          | 13      |                  |   | KTM310        | 36,50 |
| R1 / R1M                          | 98          | 20      |                  |   | KTM311        | 36,50 |
| R3                                | 15          | 20      |                  |   | KTM311        | 36,50 |
| R6                                | 06          | 20      |                  |   | KTM311        | 36,50 |
| T Max 500 - 530 - 560             | 02          | 20      |                  |   | KTM310        | 36,50 |
| X-MAX 400                         | 13          | 19      |                  |   | KTM310        | 36,50 |



# CONTRAPPESI MANUBRIO

## 102 HANDLEBAR BALANCERS



### NEW LOOK, BEST COMFORT

Riduce le vibrazioni del manubrio rispetto ai contrappesi in alluminio  
Reduces the vibrations of the handlebar compared to aluminum handlebar balancers

| Descrizione - Description                   | Anno - Year |         | Misura - measure | Codice - Code | €            |
|---|-------------|---------|------------------|---------------|--------------|
|   | dal - from  | al - to |                  |               |              |
| Universali / Universal                      |             |         | d.12/13/17       | KTM200        | <b>35,00</b> |
| <b>APRILIA</b>                              |             |         |                  |               |              |
| RS 660                                      | 20          | 21      |                  | KTM231        | <b>33,00</b> |
| RSV4 (all versions)                         | 09          | 20      |                  | KTM203        | <b>33,00</b> |
| <b>BMW</b>                                  |             |         |                  |               |              |
| R Nine-T / Scrambler / Pure / Urban / Racer | 16          | 19      |                  | KTM225        | <b>33,00</b> |
| S1000R                                      | 14          | 20      |                  | KTM225        | <b>33,00</b> |
| S1000RR                                     | 09          | 18      |                  | KTM225        | <b>33,00</b> |
| S1000RR                                     | 19          | 20      |                  | KTM230        | <b>33,00</b> |
| <b>DUCATI</b>                               |             |         |                  |               |              |
| Diavel                                      | 11          | 18      | d.12             | KTM200        | <b>35,00</b> |
| Monster 821                                 | 14          | 20      | d.17             | KTM200        | <b>35,00</b> |
| Monster 1200 S / R                          | 17          | 20      |                  | KTM200        | <b>35,00</b> |
| Multistrada                                 | 03          | 09      |                  | KTM205        | <b>33,00</b> |
| Panigale 899 / 1199 / 1299                  | 12          | 17      |                  | KTM218        | <b>33,00</b> |
| Panigale 959                                | 16          | 20      |                  | KTM218        | <b>33,00</b> |
| Panigale V2                                 | 20          | 20      |                  | KTM218        | <b>33,00</b> |
| Panigale V4                                 | 18          | 20      |                  | KTM229        | <b>33,00</b> |
| Streetfighter V4 / S                        | 20          | 20      | d.14,5           | KTM222        | <b>33,00</b> |
| 848   | 08          | 11      | d.12             | KTM200        | <b>35,00</b> |
| 1098 / 1198                                 | 07          | 11      | d.17             | KTM200        | <b>35,00</b> |
| <b>HONDA</b>                                |             |         |                  |               |              |
| tutte / all                                 | ..          | ..      |                  | KTM206        | <b>33,00</b> |
| <b>KAWASAKI</b>                             |             |         |                  |               |              |
| ER-6N                                       | 12          | 16      |                  | KTM204        | <b>33,00</b> |
| Ninja 250 / Ninja 300 / Ninja 400           | 18          | 20      |                  | KTM204        | <b>33,00</b> |
| Z125  | 19          | 20      |                  | KTM204        | <b>33,00</b> |
| Z400  | 17          | 20      |                  | KTM204        | <b>33,00</b> |
| Z650  | 17          | 20      |                  | KTM226        | <b>35,00</b> |
| Z750  | 04          | 12      |                  | KTM204        | <b>33,00</b> |
| Z 800                                       | 13          | 16      |                  | KTM207        | <b>33,00</b> |
| Z900  | 17          | 20      |                  | KTM204        | <b>33,00</b> |
| Z1000                                       | 03          | 16      |                  | KTM204        | <b>33,00</b> |
| Z1000 SX                                    | 11          | 16      |                  | KTM204        | <b>33,00</b> |
| ZX250R                                      | 09          | 12      |                  | KTM207        | <b>33,00</b> |
| ZX6R / 636                                  | 03          | 20      |                  | KTM204        | <b>33,00</b> |
| ZX10R                                       | 11          | 15      |                  | KTM204        | <b>33,00</b> |
| ZX10R                                       | 16          | 20      |                  | KTM207        | <b>33,00</b> |





| Descrizione - Description         | Anno - Year |         | Misura - measure | Codice - Code | €     |
|-----------------------------------|-------------|---------|------------------|---------------|-------|
|                                   | dal - from  | al - to |                  |               |       |
| <b>KTM</b>                        |             |         |                  |               |       |
| DUKE 390                          | 17          | 20      |                  | KTM211        | 33,00 |
| DUKE 790                          | 18          | 20      |                  | KTM200        | 33,00 |
| DUKE 890 R                        | 20          | 20      |                  | KTM200        | 33,00 |
| DUKE 1290R                        | 20          | 20      |                  | KTM200        | 35,00 |
| <b>MV</b>                         |             |         |                  |               |       |
| BRUTALE - 4 cilindri tutte / all  | 01          | 17      |                  | KTM220        | 33,00 |
| Brutale B3 - 3 cilindri 675 / 800 | 12          | 17      |                  | KTM220        | 33,00 |
| F3 675 / 800                      | 11          | 17      |                  | KTM219        | 33,00 |
| F4 tutte / all                    | 10          | 17      |                  | KTM223        | 33,00 |
| <b>SUZUKI</b>                     |             |         |                  |               |       |
| Gladius 650                       | 09          | 15      |                  | KTM209        | 33,00 |
| GSR 600                           | 06          | 11      |                  | KTM205        | 33,00 |
| GSR 750                           | 11          | 16      |                  | KTM205        | 33,00 |
| GSXR 600 / 750                    | 00          | 05      |                  | KTM205        | 33,00 |
| GSXR 600 / 750                    | 06          | 17      |                  | KTM209        | 33,00 |
| GSXR 1000                         | 03          | 04      |                  | KTM205        | 33,00 |
| GSXR 1000                         | 05          | 16      |                  | KTM209        | 33,00 |
| GSXR 1000                         | 17          | 20      |                  | KTM227        | 38,00 |
| GSXS 750                          | 17          | 20      |                  | KTM228        | 35,00 |
| GSXS 1000                         | 15          | 20      |                  | KTM200        | 35,00 |
| <b>TRIUMPH</b>                    |             |         |                  |               |       |
| STREET TRIPLE 675                 | 07          | 12      |                  | KTM200        | 35,00 |
| STREET TRIPLE 675 R               | 13          | 16      |                  | KTM211        | 33,00 |
| STREET TRIPLE 765 R / S / RS      | 17          | 20      |                  | KTM211        | 33,00 |
| <b>YAMAHA</b>                     |             |         |                  |               |       |
| Fazer 600 - FZ6                   | 04          | 06      |                  | KTM210        | 33,00 |
| FZ1                               | 06          | 11      |                  | KTM211        | 33,00 |
| Fazer 1000                        | 01          | 12      |                  | KTM210        | 33,00 |
| MT-07 / XSR-700                   | 14          | 20      |                  | KTM210        | 33,00 |
| MT-09                             | 13          | 20      |                  | KTM210        | 33,00 |
| MT-10                             | 16          | 20      |                  | KTM210        | 33,00 |
| R 125                             | 08          | 13      |                  | KTM210        | 33,00 |
| R1 / R1M                          | 98          | 20      |                  | KTM211        | 33,00 |
| R3                                | 15          | 20      |                  | KTM211        | 33,00 |
| R6                                | 06          | 20      |                  | KTM211        | 33,00 |
| T Max 500 - 530 - 560             | 02          | 20      |                  | KTM210        | 33,00 |
| X-MAX 400                         | 13          | 19      |                  | KTM210        | 33,00 |

BORN  
TO BE  
MOTO



**SPECCHIETTI**  
MIRRORS



# SPECCHIETTI IN ALLUMINIO PER NAKED

106 ALUMINIUM MIRRORS FOR NAKED

**HOMOLOGATED**



Omologato  
Homologated



Coppia specchi alluminio (filetto 2xM10x1,25 Right + 1xM10x1,25 Left)  
Aluminium mirrors couple (thread 2xM10x1,25 Right + 1xM10x1,25 Left)

■ SPEAL031NER

a coppia - for pair  
€ 218,00

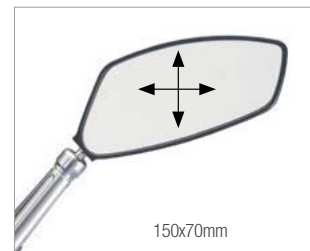

Coppia specchi alluminio (filetto 2xM10x1,25 Right + 1xM10x1,25 Left)  
Aluminium mirrors couple (thread 2xM10x1,25 Right + 1xM10x1,25 Left)

■ SPEAL027NER

a coppia - for pair  
€ 207,00

# SPECCHIETTI IN ALLUMINIO PER NAKED



|   |  |                                 |
|---|--|---------------------------------|
| Coppia specchi alluminio (filetto 2xM10x1,25 Right + 1xM10x1,25 Left)<br>Aluminium mirrors couple (thread 2xM10x1,25 Right + 1xM10x1,25 Left) | <input type="checkbox"/> SPEAL014BIA<br><input checked="" type="checkbox"/> SPEAL014NER<br><input checked="" type="checkbox"/> SPEAL014ROS | a coppia - for pair<br>€ 207,00 |
| Coppia specchi per T-MAX fissaggio a manubrio<br>Pair of mirrors for T-MAX, fixing on handlebar   | <input type="checkbox"/> SPEAL015BIA<br><input checked="" type="checkbox"/> SPEAL015NER<br><input checked="" type="checkbox"/> SPEAL015ROS | € 207,00                        |
| Coppia specchi per T-MAX fissaggio su carena, completo di adattatori<br>Pair of mirrors for T-MAX, fixing on fairing, adaptors included       | <input type="checkbox"/> SPEAL019BIA<br><input checked="" type="checkbox"/> SPEAL019NER<br><input checked="" type="checkbox"/> SPEAL019ROS | € 277,00                        |



|  |   |                                |
|--|---|--------------------------------|
| Kit conversione attacchi specchio SPEAL015 T-Max (da manubrio a carena ) in abbinamento con SPEY09<br>Conversion kit for T-Max mirrors SPEAL015 fitment (from handlebar to fairing) in combination with SPEY09 | <input checked="" type="checkbox"/> SPEY10      | a coppia - for pair<br>€ 36,50 |
| Kit conversione attacchi specchio (SPEAL015) per T-Max (da carena a manubrio ) con leve originali<br>Conversion kit mirror fitment (SPEAL015) for T-Max (from fairing to handlebar) with OEM levers            | <input checked="" type="checkbox"/> SPEY12      | € 36,50                        |
| Kit conversione attacchi specchio (SPEAL015) per T-Max (da carena a manubrio ) con leve Lighttech<br>Conversion kit mirror fitment (SPEAL015) for T-Max (from fairing to handlebar) with Lighttech levers      | <input checked="" type="checkbox"/> SPEY13      | € 36,50                        |
| Coppia adattatori specchio con filetto (da M10x1,25 femmina a M10 maschio DX + SX)<br>Pair of mirror adaptors with thread (female M10x1.25 to male M10 left+right)   | <input checked="" type="checkbox"/> SPEAL021NER | € 12,00                        |
| Coppia adattatori specchio con filetto (da M10x1,25 femmina a M8 maschio DX + SX)<br>Pair of mirror adaptors with thread (female M10x1.25 to male M8 left+right)   | <input checked="" type="checkbox"/> SPEAL022    | € 12,00                        |
| Coppia adattatori specchio per BMW con filetto (da M10x1,5 a M8 / DX + SX)<br>Pair of mirrors adaptors with thread (from M10x1,5 to M8 / R + L) for BMW Models   | <input checked="" type="checkbox"/> SPEAL025    | € 12,00                        |
| Kit viti per montaggio specchi SPEAL015 su T-Max (con leve originali)<br>Bolts kit for fitting SPEAL015 mirrors on T-Max (with OEM levers)   | <input checked="" type="checkbox"/> SPEAL026    | € 12,00                        |
| Coppia adattatori specchio per conversione da M8 DX a M8 (DX + SX)<br>Pair of mirrors adaptors for conversion from M8 right to M8 right + M8 left  | <input checked="" type="checkbox"/> SPEAL030    | € 12,00                        |
| Coppia adattatori specchio per MV Agusta BRUTALE 4 CILINDRI<br>Pair of mirror adaptors for MV Agusta Brutale 4 pistons   | <input checked="" type="checkbox"/> SPEAL032    | € 18,00                        |
| Kit viti per specchi SPEAL014 con filetto M8 DX + SX<br>Bolts kit for mirrors SPEAL014 with thread M8 left + right   | <input checked="" type="checkbox"/> SPEAL033    | € 12,00                        |

**TAPPI SPECCHIO**  
MIRROR  
BLOCK-OFF PLATES





# TAPPI SPECCHIO

## 110 MIRROR BLOCK-OFF PLATES

| Articolo - Article  |                     | Anno - Year |    | Codice - Code | €      |              |
|---------------------|---------------------|-------------|----|---------------|--------|--------------|
| a coppia - for pair |                     |             |    |               |        |              |
| <b>APRILIA</b>      | RS 660              | 20          | 21 | ■ ■           | SPE111 | <b>33,00</b> |
|                     | RSV4 (all versions) | 09          | 20 | ■ ■           | SPE111 | <b>33,00</b> |
| <b>BMW</b>          | S1000 RR            | 09          | 18 | ■ ■ ■ ■       | SPE101 | <b>29,00</b> |
|                     | S1000 RR            | 19          | 20 | ■ ■ ■ ■       | SPE122 | <b>48,00</b> |
| <b>DUCATI</b>       | PANIGALE 899 / 1199 | 12          | 15 | ■ ■           | SPE113 | <b>57,00</b> |
|                     | PANIGALE 1299       | 15          | 17 | ■ ■           | SPE117 | <b>48,00</b> |
|                     | PANIGALE 959        | 16          | 20 | ■ ■           | SPE117 | <b>48,00</b> |
|                     | PANIGALE V4 / S     | 18          | 19 | ■ ■           | SPE121 | <b>48,00</b> |
|                     | PANIGALE V4 / S     | 20          | 20 | ■ ■           | SPE123 | <b>48,00</b> |
|                     | PANIGALE V4 R       | 20          | 20 | ■ ■           | SPE123 | <b>48,00</b> |



SPE111

SPE101

SPE122

SPE117









SPE121

SPE123







| Articolo - Article |                                  | Anno - Year |    | Codice - Code |        | €            |  |
|--------------------|----------------------------------|-------------|----|---------------|--------|--------------|--|
|                    |                                  |             |    |               |        |              | a coppia - for pair  |
| <b>HONDA</b>       | CBR 500R                         | 16          | 20 | ■ ■           | SPE102 | <b>29,00</b> |  SPE105<br> SPE125   |
|                    | CBR 600 RR                       | 04          | 16 | ■ ■           | SPE105 | <b>29,00</b> |  |
|                    | CBR 1000 RR                      | 04          | 07 | ■ ■           | SPE105 | <b>29,00</b> |  |
|                    | CBR 1000 RR / CBR 1000 RR-R / SP | 08          | 20 | ■ ■           | SPE125 | <b>48,00</b> |  |
| <b>KAWASAKI</b>    | Ninja 400                        | 18          | 20 | ■ ■           | SPE118 | <b>33,00</b> |  SPE102<br> SPE110<br> SPE112<br> SPE118 |
|                    | ZX6R                             | 05          | 08 | ■ ■           | SPE102 | <b>29,00</b> |  |
|                    | ZX6R                             | 09          | 12 | ■ ■           | SPE110 | <b>29,00</b> |  |
|                    | ZX10R                            | 04          | 07 | ■ ■           | SPE102 | <b>29,00</b> |  |
|                    | ZX10R                            | 11          | 15 | ■ ■           | SPE112 | <b>33,00</b> |  |
|                    | ZX10R                            | 16          | 20 | ■ ■           | SPE118 | <b>33,00</b> |  |
| <b>MV AGUSTA</b>   | F3 675 / F3 800                  | 12          | 20 | ■ ■           | SPE114 | <b>43,00</b> |  SPE114   |

# TAPPI SPECCHIO

## 112 MIRROR BLOCK-OFF PLATES

| Articolo - Article  |                       | Anno - Years |    | Codice - Code |        | €            |  |
|---------------------|-----------------------|--------------|----|---------------|--------|--------------|--|
| a coppia - for pair |                       |              |    |               |        |              |  |
| <b>SUZUKI</b>       | GSXR 600 / 750 / 1000 | 05           | 16 |               | SPE103 | <b>29,00</b> |  |
|                     | GSXR 1000             | 17           | 20 |               | SPE119 | <b>48,00</b> |  |
| <b>YAMAHA</b>       | R3                    | 19           | 20 |               | SPE126 | <b>48,00</b> |  |
|                     | R6                    | 99           | 07 |               | SPE104 | <b>29,00</b> |  |
|                     | R6                    | 17           | 20 |               | SPE120 | <b>48,00</b> |  |
|                     | R1                    | 98           | 06 |               | SPE104 | <b>29,00</b> |  |
|                     | R1                    | 07           | 14 |               | SPE101 | <b>29,00</b> |  |
|                     | R1 / R1M              | 15           | 19 |               | SPE115 | <b>48,00</b> |  |
|                     | R1 / R1M              | 20           | 20 |               | SPE124 | <b>48,00</b> |  |
|                     | TMAX 530 - 560        | 12           | 20 |               | SPEY08 | <b>49,00</b> |  |



**PORTA TARGA**  
LICENSE PLATE HOLDER



## PORTA TARGA REGOLABILI

114 ADJUSTABLE LICENSE PLATE HOLDERS

### FACILE E VELOCE

EASY AND FAST

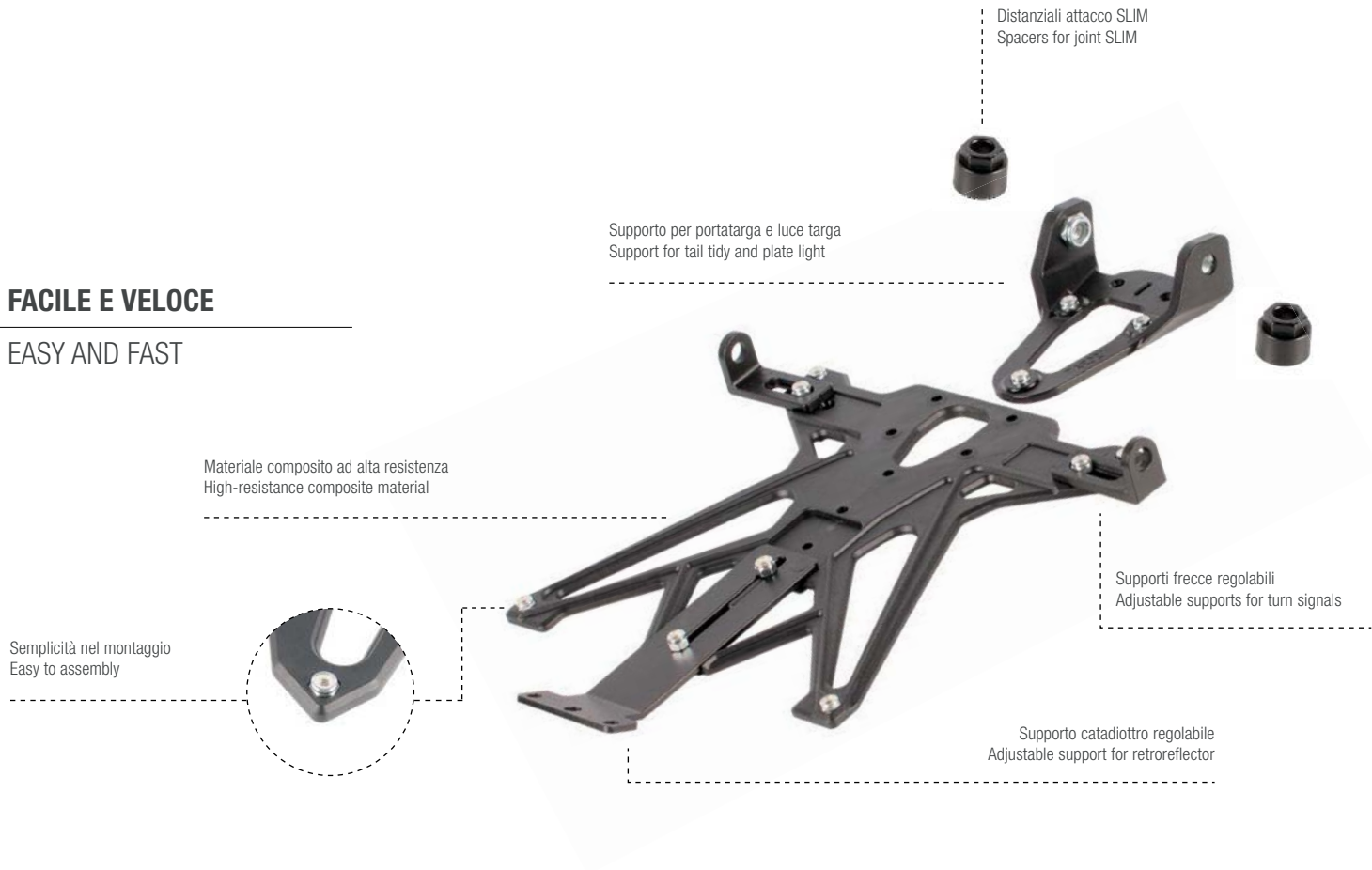

### NEL PIENO RISPETTO DEL CODICE DELLA STRADA

FOR LEGAL STREET USE

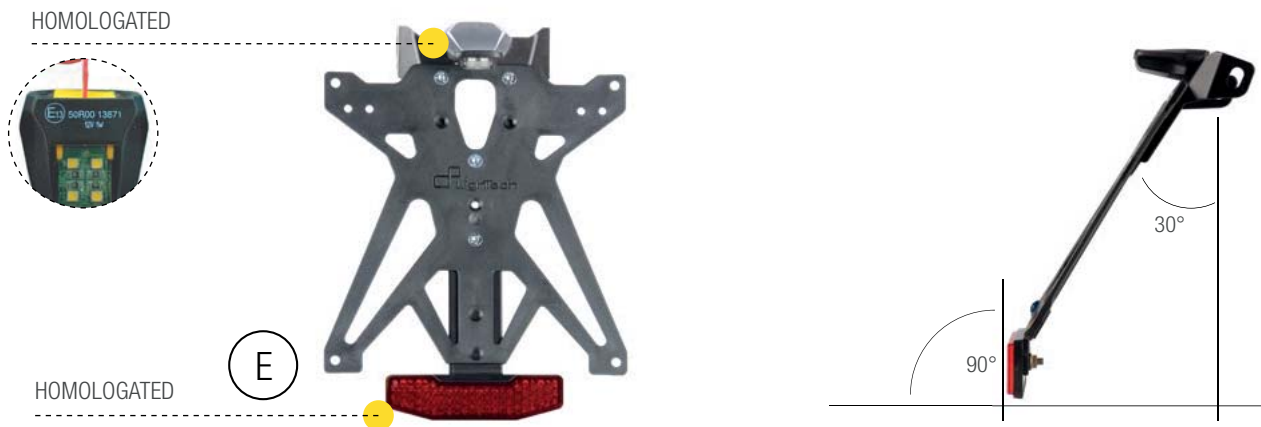



**KIT PORTATARGA COMPLETO DI CATADIOTTRO E LUCE TARGA OMOLOGATI**  
LICENSE PLATE KIT COMPLETE WITH APPROVED RETROREFLECTOR AND LICENSE PLATE LIGHT



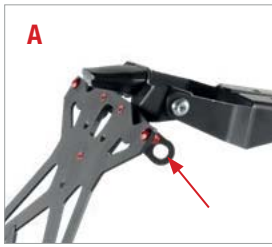

attacco per freccia Ø 8 /  
hole for Ø 8 turn signal

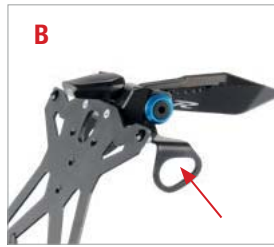

attacco per freccia originale / with hole  
for original turn signals



luce in dotazione /  
light supplied



comprensivo di catadiottro /  
retroreflector included

**\*\***

IMPORTANTE: aggiungere il codice della sigla dello stato (vedi esempio pag 124)

IMPORTANT: add the code of the country (see example page 124)

| Modello - Model   | Anno - Year |         | foro per frecce<br>hole for turn signals |          | luce<br>light | catadiottro<br>retroreflector | TÜV<br>homologated | Codice - Code | €          |        |
|---|-------------|---------|--|----------|---------------|-------------------------------|--------------------|---------------|------------|--------|
|   | dal - from  | al - to | racing                                   | original |               |                               |                    |               |            |        |
| Universal<br>vedi pagina 122 / see page 122                                 |             |         | ✓  |          |               |                               |                    | TAR013        | 54,00      |        |
| <b>FINE SERIE - END STOCK</b>   |             |         |  |          |               |                               |                    |               |            |        |
| <b>APRILIA</b>  |             |         |  |          |               |                               |                    |               |            |        |
| RS 660  | 20          | 21      | ✓  | ✓        | LT009         | ✓                             | NO                 | KTARAP109**   | 95,00      | kit    |
|   |             |         | ✓  | ✓        |               |                               |                    |               | TARAP109** | 70,00  |
| Dorsoduro 900   | 18          | 20      | ✓  | ✓        | LT009         | ✓                             | YES                | KTARAP108**   | 95,00      | kit    |
|   |             |         | ✓  | ✓        |               |                               |                    |               | TARAP108** | 70,00  |
| Dorsoduro 1200  | 11          | 15      | ✓  | ✓        | LT009         | ✓                             | NO                 | KTARAP108**   | 95,00      | kit    |
|   |             |         | ✓  | ✓        |               |                               |                    |               | TARAP108** | 70,00  |
| RSV4 (all versions)   | 09          | 20      | ✓  | ✓        | LT009         | ✓                             | YES                | KTARAP107**   | 92,00      | kit    |
|   |             |         | ✓  | ✓        |               |                               |                    |               | TARAP107** | 66,50  |
| Tuono 660   | 20          | 21      | ✓  | ✓        | LT009         | ✓                             | NO                 | KTARAP109**   | 95,00      | kit    |
|   |             |         | ✓  | ✓        |               |                               |                    |               | TARAP109** | 70,00  |
| Tuono (all versions)  | 11          | 20      | ✓  | ✓        | LT009         | ✓                             | YES                | KTARAP107**   | 92,00      | kit    |
|   |             |         | ✓  | ✓        |               |                               |                    |               | TARAP107** | 66,50  |
| <b>BMW</b>  |             |         |  |          |               |                               |                    |               |            |        |
| C600 sport  | 12          | 15      | ✓  | ✓        | LT009         | ✓                             | NO                 | KTARBM104**   | 124,00     | kit    |
|   |             |         | ✓  | ✓        |               |                               |                    |               | TARBM104** | 98,00  |
| R 1200 GS   | 13          | 17      |  | ✓        | LT009         | ✓                             | NO                 | KTARBM108**   | 92,00      | kit    |
|   |             |         |  | ✓        |               |                               |                    |               | TARBM108** | 66,50  |
| R NINE-T Scrambler / Urban / Racer / Pure<br>vedi pagina 123 / see page 123 | 16          | 19      | ✓  | ✓        | LT009         | ✓                             | NO                 | KTARBM109**   | 320,00     | kit    |
|   |             |         | ✓  | ✓        | LT009         | ✓                             |                    |               | TARBM110** | 320,00 |
| S1000R  | 14          | 20      | ✓  | ✓        | LT009         | ✓                             | YES                | KTARBM105**   | 107,00     | kit    |
|   |             |         | ✓  | ✓        |               |                               |                    |               | TARBM105** | 82,00  |
| S1000RR / HP4   | 09          | 18      | ✓  | ✓        | LT009         | ✓                             | YES                | KTARBM105**   | 107,00     | kit    |
|   |             |         | ✓  | ✓        |               |                               |                    |               | TARBM105** | 82,00  |
| S1000RR   | 19          | 20      | ✓  | ✓        | LT009         | ✓                             | YES                | KTARBM111**   | 107,00     | kit    |
|   |             |         | ✓  | ✓        |               |                               |                    |               | TARBM111** | 82,00  |
| <b>DUCATI</b>   |             |         |  |          |               |                               |                    |               |            |        |
| 848 - 1098 - 1198   | 07          | 11      | ✓  | ✓        | LT009         | ✓                             | NO                 | KTARDU104**   | 95,00      | kit    |
|   |             |         | ✓  | ✓        |               |                               |                    |               | TARDU104** | 70,00  |
| Hypermotard 796 - 1100  | 07          | 12      | ✓  |          | LT009         | ✓                             | NO                 | KTARDU105**   | 92,00      | kit    |
|   |             |         | ✓  |          |               |                               |                    |               | TARDU105** | 66,50  |
| Hypermotard 821 / 939   | 13          | 18      | ✓  |          | LT009         | ✓                             | YES                | KTARDU110**   | 100,00     | kit    |
|   |             |         | ✓  |          |               |                               |                    |               | TARDU110** | 74,00  |

NEW!

| Modello - Model                             | Anno - Year |         | A  |          | B             | C                             | D         | TÜV homologated | Codice - Code | €   | FINE SERIE - END STOCK |
|---|-------------|---------|--|----------|---------------|-------------------------------|-----------|-----------------|---------------|-----|------------------------|
|   |             |         | foro per frecce<br>hole for turn signals |          | luci<br>light | catadiottro<br>retroreflector | KBA 91919 |                 |               |     |                        |
|   | dal - from  | al - to | racing                                   | original |               |                               |           |                 |               |     |                        |
| <b>DUCATI</b>                               |             |         |  |          |               |                               |           |                 |               |     |                        |
| Hypermotard 950 / SP                        | 19          | 20      | ✓  | ✓        | LT009         | ✓                             | NO        | KTARDU114**     | 100,00        | kit |                        |
|   |             |         | ✓  | ✓        |               |                               |           | TARDU114**      | 74,00         |     |                        |
| Monster 797                                 | 17          | 20      | ✓  | ✓        | LT009         | ✓                             | YES       | KTARDU112**     | 100,00        | kit |                        |
|   |             |         | ✓  | ✓        |               |                               |           | TARDU112**      | 74,00         |     |                        |
| Monster 1200 / S / R                        | 17          | 20      | ✓  | ✓        | LT009         | ✓                             | YES       | KTARDU112**     | 100,00        | kit |                        |
|   |             |         | ✓  | ✓        |               |                               |           | TARDU112**      | 74,00         |     |                        |
| Panigale 899                                | 12          | 17      | ✓  | ✓        | LT009         | ✓                             | YES       | KTARDU109**     | 207,00        | kit |                        |
|   |             |         | ✓  | ✓        |               |                               |           | TARDU109**      | 182,00        |     |                        |
| Panigale 959                                | 16          | 20      | ✓  | ✓        | LT009         | ✓                             | YES       | KTARDU109**     | 207,00        | kit |                        |
|   |             |         | ✓  | ✓        |               |                               |           | TARDU109**      | 182,00        |     |                        |
| Panigale 1199 / 1299 R / S / Superleggera   | 12          | 17      | ✓  | ✓        | LT009         | ✓                             | YES       | KTARDU109**     | 207,00        | kit |                        |
|   |             |         | ✓  | ✓        |               |                               |           | TARDU109**      | 182,00        |     |                        |
| Panigale V2 955                             | 20          | 20      | ✓  | ✓        | LT009         | ✓                             | YES       | KTARDU113**     | 207,00        | kit |                        |
|   |             |         | ✓  | ✓        |               |                               |           | TARDU113**      | 182,00        |     |                        |
| Panigale V4 / S / R / Speciale              | 18          | 20      | ✓  | ✓        | LT009         | ✓                             | YES       | KTARDU113**     | 207,00        | kit |                        |
|   |             |         | ✓  | ✓        |               |                               |           | TARDU113**      | 182,00        |     |                        |
| Supersport 939 / S                          | 17          | 20      | ✓  | ✓        | LT009         | ✓                             | YES       | KTARDU112**     | 100,00        | kit |                        |
|   |             |         | ✓  | ✓        |               |                               |           | TARDU112        | 74,00         |     |                        |
| Streetfighter 1100 / 848                    | 09          | 17      | ✓  | ✓        | LT009         | ✓                             | NO        | KTARDU106**     | 95,00         | kit |                        |
|   |             |         | ✓  | ✓        |               |                               |           | TARDU106**      | 70,00         |     |                        |
| Streetfighter V4 / S                        | 20          | 20      | ✓  | ✓        | LT009         | ✓                             | YES       | KTARDU113**     | 207,00        | kit |                        |
|   |             |         | ✓  | ✓        |               |                               |           | TARDU113**      | 182,00        |     |                        |
| <b>FANTIC</b>                               |             |         |  |          |               |                               |           |                 |               |     |                        |
| Caballero 125 / 250 / 500 Scrambler / Rally | 19          | 20      | ✓  | ✓        | LT009         | ✓                             | YES       | KTARFA101**     | 92,00         | kit |                        |
|   |             |         | ✓  | ✓        |               |                               |           | TARFA101**      | 66,50         |     |                        |
| Caballero 125 / 250 / 500 - flat track      | 19          | 20      | ✓  | ✓        | LT009         | ✓                             | NO        | KTARFA102**     | 92,00         | kit |                        |
|   |             |         | ✓  | ✓        |               |                               |           | TARFA102**      | 66,50         |     |                        |
| <b>GUZZI</b>                                |             |         |  |          |               |                               |           |                 |               |     |                        |
| GRISO 850 / 1100 / 1150                     | 06          | 16      | ✓  | ✓        | LT009         | ✓                             | NO        | KTARGU101**     | 92,00         | kit |                        |
|   |             |         | ✓  | ✓        |               |                               |           | TARGU101**      | 66,50         |     |                        |
| <b>HONDA</b>                                |             |         |  |          |               |                               |           |                 |               |     |                        |
| CB 125R / CB300R                            | 18          | 20      | ✓  | ✓        | LT009         | ✓                             | YES       | KTARHO117**     | 92,00         | kit |                        |
|   |             |         | ✓  | ✓        |               |                               |           | TARHO117**      | 66,50         |     |                        |
| CB 650 F                                    | 14          | 19      | ✓  | ✓        | LT009         | ✓                             | YES       | KTARHO111**     | 92,00         | kit |                        |
|   |             |         | ✓  | ✓        |               |                               |           | TARHO111**      | 66,50         |     |                        |
| CB 650 R                                    | 19          | 20      | ✓  | ✓        | LT009         | ✓                             | YES       | KTARHO118**     | 92,00         | kit |                        |
|   |             |         | ✓  | ✓        |               |                               |           | TARHO118**      | 66,50         |     |                        |
| CB 650 R                                    | 21          | 21      | ✓  | ✓        | LT009         | ✓                             | NO        | KTARHO121**     | 100,00        | kit |                        |
|   |             |         | ✓  | ✓        |               |                               |           | TARHO121**      | 74,00         |     |                        |
| CB 1000R                                    | 08          | 17      | ✓  | ✓        | LT009         | ✓                             | NO        | KTARHO107**     | 92,00         | kit |                        |
|   |             |         | ✓  | ✓        |               |                               |           | TARHO107**      | 66,50         |     |                        |
| CB 1000R                                    | 18          | 20      | ✓  | ✓        | LT009         | ✓                             | YES       | KTARHO116**     | 100,00        | kit |                        |
|   |             |         | ✓  | ✓        |               |                               |           | TARHO116**      | 74,00         |     |                        |
| CB 500R                                     | 16          | 20      | ✓  | ✓        | LT009         | ✓                             | NO        | KTARHO120**     | 100,00        | kit |                        |
|   |             |         | ✓  | ✓        |               |                               |           | TARHO120**      | 74,00         |     |                        |

| Modello - Model    | Anno - Year |         | A  |          | B             |   | C                             |     | D           |        | TÜV homologated | Codice - Code | € | FINE SERIE - END STOCK |
|--------------------|-------------|---------|--|----------|---------------|---|-------------------------------|-----|-------------|--------|-----------------|---------------|---|------------------------|
|                    |             |         | foro per frecce<br>hole for turn signals |          | luci<br>light |   | catadiottro<br>retroreflector |     | KBA 91919   |        |                 |               |   |                        |
|                    | dal - from  | al - to | racings                                  | original |               |   |                               |     |             |        |                 |               |   |                        |
| <b>HONDA</b>       |             |         |  |          |               |   |                               |     |             |        |                 |               |   |                        |
| CBR 600 F          | 11          | 13      | ✓  |          | LT009         | ✓ |                               | NO  | KTARHO108** | 92,00  | kit             |               |   |                        |
|                    |             |         | ✓  |          |               |   |                               |     | TARHO108**  | 66,50  |                 |               |   |                        |
| CBR 650 F          | 14          | 18      | ✓  |          | LT009         | ✓ |                               | YES | KTARHO111** | 92,00  | kit             |               |   |                        |
|                    |             |         | ✓  |          |               |   |                               |     | TARHO111**  | 66,50  |                 |               |   |                        |
| CBR 650 R          | 19          | 20      | ✓  | ✓        | LT009         | ✓ |                               | YES | KTARHO118** | 92,00  | kit             |               |   |                        |
|                    |             |         | ✓  | ✓        |               |   |                               |     | TARHO118**  | 66,50  |                 |               |   |                        |
| CBR 650 R          | 21          | 21      | ✓  | ✓        | LT009         | ✓ |                               | NO  | KTARHO121** | 100,00 | kit             |               |   |                        |
|                    |             |         | ✓  | ✓        |               |   |                               |     | TARHO121**  | 74,00  |                 |               |   |                        |
| CBR 600 RR         | 13          | 16      | ✓  |          | LT009         | ✓ |                               | NO  | KTARHO112** | 107,00 | kit             |               |   |                        |
|                    |             |         | ✓  |          |               |   |                               |     | TARHO112**  | 81,00  |                 |               |   |                        |
| CBR 1000 RR        | 10          | 16      | ✓  |          | LT009         | ✓ |                               | NO  | KTARHO109** | 92,00  | kit             |               |   |                        |
|                    |             |         | ✓  |          |               |   |                               |     | TARHO109**  | 66,50  |                 |               |   |                        |
| CBR 1000 RR        | 17          | 19      | ✓  | ✓        | LT009         | ✓ |                               | YES | KTARHO114** | 92,00  | kit             |               |   |                        |
|                    |             |         | ✓  | ✓        |               |   |                               |     | TARHO114**  | 66,50  |                 |               |   |                        |
| CBR 1000 RR-R / SP | 20          | 20      | ✓  | ✓        | LT009         | ✓ |                               | YES | KTARHO119** | 107,00 | kit             |               |   |                        |
|                    |             |         | ✓  | ✓        |               |   |                               |     | TARHO119**  | 81,00  |                 |               |   |                        |
| HORNET 600         | 11          | 13      | ✓  |          | LT009         | ✓ |                               | NO  | KTARHO108** | 92,00  | kit             |               |   |                        |
|                    |             |         | ✓  |          |               |   |                               |     | TARHO108**  | 66,50  |                 |               |   |                        |
| INTEGRA 700 / 750  | 12          | 15      | ✓  |          | LT008         | ✓ |                               | NO  | KTARHO110** | 91,50  | kit             |               |   |                        |
|                    |             |         | ✓  |          | LT008         |   |                               |     | TARHO110**  | 88,00  |                 |               |   |                        |
| INTEGRA 750        | 16          | 18      | ✓  | ✓        | LT009         | ✓ |                               | NO  | KTARHO113** | 92,00  | kit             |               |   |                        |
|                    |             |         | ✓  | ✓        |               |   |                               |     | TARHO113**  | 66,50  |                 |               |   |                        |
| NC 700 / NC 700 X  | 12          | 15      | ✓  |          | LT008         | ✓ |                               | NO  | KTARHO110** | 91,50  | kit             |               |   |                        |
|                    |             |         | ✓  |          | LT008         |   |                               |     | TARHO110**  | 88,00  |                 |               |   |                        |
| X-ADV 750          | 17          | 20      |  | ✓        | LT009         | ✓ |                               | YES | KTARHO115** | 181,00 | kit             |               |   |                        |
|                    |             |         |  | ✓        |               |   |                               |     | TARHO115**  | 156,00 |                 |               |   |                        |
| X-ADV 750          | 21          | 21      |  | ✓        | LT009         | ✓ |                               | NO  | KTARHO122** |        | kit             |               |   |                        |
|                    |             |         |  | ✓        |               |   |                               |     | TARHO122**  |        |                 |               |   |                        |
| <b>HUSQVARNA</b>   |             |         |  |          |               |   |                               |     |             |        |                 |               |   |                        |
| NUDA 900           | 11          | 13      | ✓  | ✓        | LT009         | ✓ |                               | NO  | KTARHU101** | 113,00 | kit             |               |   |                        |
|                    |             |         | ✓  | ✓        |               |   |                               |     | TARHU101**  | 87,00  |                 |               |   |                        |
| VITPILEN 701       | 18          | 19      | ✓  | ✓        | LT009         | ✓ |                               | NO  | KTARHU102** | 127,00 | kit             |               |   |                        |
|                    |             |         | ✓  | ✓        |               |   |                               |     | TARHU102**  | 101,50 |                 |               |   |                        |
| <b>KAWASAKI</b>    |             |         |  |          |               |   |                               |     |             |        |                 |               |   |                        |
| ER - 6N            | 12          | 20      | ✓  | ✓        | LT009         | ✓ |                               | NO  | KTARKA116** | 113,00 | kit             |               |   |                        |
|                    |             |         | ✓  | ✓        |               |   |                               |     | TARKA116**  | 87,00  |                 |               |   |                        |
| Ninja 125          | 19          | 20      | ✓  | ✓        | LT009         | ✓ |                               | YES | KTARKA125** | 92,00  | kit             |               |   |                        |
|                    |             |         | ✓  | ✓        |               |   |                               |     | TARKA125**  | 66,50  |                 |               |   |                        |
| Ninja 250          | 18          | 20      | ✓  | ✓        | LT009         | ✓ |                               | NO  | KTARKA124** | 92,00  | kit             |               |   |                        |
|                    |             |         | ✓  | ✓        |               |   |                               |     | TARKA124**  | 66,50  |                 |               |   |                        |
| Ninja 300          | 12          | 16      | ✓  |          | LT009         | ✓ |                               | NO  | KTARKA118** | 92,00  | kit             |               |   |                        |
|                    |             |         | ✓  |          |               |   |                               |     | TARKA118**  | 66,50  |                 |               |   |                        |
| Ninja 400          | 17          | 20      | ✓  | ✓        | LT009         | ✓ |                               | YES | KTARKA124** | 92,00  | kit             |               |   |                        |
|                    |             |         | ✓  | ✓        |               |   |                               |     | TARKA124**  | 66,50  |                 |               |   |                        |

NEW!

NEW!



| Modello - Model | Anno - Year | foro per frecce<br>hole for turn signals |         | C<br>luci<br>light | D<br>catadiottro<br>retroreflector | TÜV<br>homologated | Codice - Code | €           | FINE SERIE - END STOCK |     |
|-----------------|-------------|--|---------|--------------------|------------------------------------|--------------------|---------------|-------------|------------------------|-----|
|                 |             | A  | B       |                    |                                    |                    |               |             |                        |     |
|                 |             | dal - from                               | al - to | racings            | original                           | KBA 91919          |               |             |                        |     |
| <b>KAWASAKI</b> |             |  |         |                    |                                    |                    |               |             |                        |     |
| Ninja 650       | 16          | 21                                       | ✓       | ✓                  | LT009                              | ✓                  | YES           | KTARKA122** | 95,00                  | kit |
|                 |             |  | ✓       | ✓                  |                                    |                    |               | TARKA122**  | 70,00                  |     |
| Ninja 1000 SX   | 11          | 20                                       | ✓       |                    | LT009                              | ✓                  | YES           | KTARKA115** | 92,00                  | kit |
|                 |             |  | ✓       |                    |                                    |                    |               | TARKA115**  | 66,50                  |     |
| VERDIS 1000     | 19          | 20                                       | ✓       |                    | LT009                              | ✓                  | YES           | KTARKA115** | 92,00                  | kit |
|                 |             |  | ✓       |                    |                                    |                    |               | TARKA115**  | 66,50                  |     |
| Z 125           | 19          | 20                                       | ✓       | ✓                  | LT009                              | ✓                  | YES           | KTARKA125** | 92,00                  | kit |
|                 |             |  | ✓       | ✓                  |                                    |                    |               | TARKA125**  | 66,50                  |     |
| Z 300           | 12          | 16                                       | ✓       |                    | LT009                              | ✓                  | NO            | KTARKA118** | 92,00                  | kit |
|                 |             |  | ✓       |                    |                                    |                    |               | TARKA118**  | 66,50                  |     |
| Z 400           | 17          | 20                                       | ✓       | ✓                  | LT009                              | ✓                  | YES           | KTARKA124** | 92,00                  | kit |
|                 |             |  | ✓       | ✓                  |                                    |                    |               | TARKA124**  | 66,50                  |     |
| Z 650           | 16          | 20                                       | ✓       | ✓                  | LT009                              | ✓                  | YES           | KTARKA122** | 95,00                  | kit |
|                 |             |  | ✓       | ✓                  |                                    |                    |               | TARKA122**  | 70,00                  |     |
| Z 750           | 07          | 14                                       | ✓       |                    | LT009                              | ✓                  | NO            | KTARKA109** | 92,00                  | kit |
|                 |             |  | ✓       |                    |                                    |                    |               | TARKA109**  | 66,50                  |     |
| Z 800           | 13          | 16                                       | ✓       |                    | LT009                              | ✓                  | NO            | KTARKA117** | 92,00                  | kit |
|                 |             |  | ✓       |                    |                                    |                    |               | TARKA117**  | 66,50                  |     |
| Z 900           | 17          | 20                                       | ✓       | ✓                  | LT009                              | ✓                  | YES           | KTARKA123** | 95,00                  | kit |
|                 |             |  | ✓       | ✓                  |                                    |                    |               | TARKA123**  | 70,00                  |     |
| Z 1000          | 07          | 09                                       | ✓       |                    | LT009                              | ✓                  | NO            | KTARKA109** | 92,00                  | kit |
|                 |             |  | ✓       |                    |                                    |                    |               | TARKA109**  | 66,50                  |     |
| Z 1000          | 10          | 13                                       | ✓       |                    | LT009                              | ✓                  | YES           | KTARKA115** | 92,00                  | kit |
|                 |             |  | ✓       |                    |                                    |                    |               | TARKA115**  | 66,50                  |     |
| Z 1000          | 14          | 20                                       | ✓       |                    | LT009                              | ✓                  | YES           | KTARKA119** | 92,00                  | kit |
|                 |             |  | ✓       |                    |                                    |                    |               | TARKA119**  | 66,50                  |     |
| Z 1000 SX       | 11          | 20                                       | ✓       |                    | LT009                              | ✓                  | YES           | KTARKA115** | 92,00                  | kit |
|                 |             |  | ✓       |                    |                                    |                    |               | TARKA115**  | 66,50                  |     |
| Z H2            | 20          | 20                                       | ✓       | ✓                  | LT009                              | ✓                  | YES           | KTARKA123** | 95,00                  | kit |
|                 |             |  | ✓       | ✓                  |                                    |                    |               | TARKA123**  | 70,00                  |     |
| ZX6R / 636      | 13          | 17                                       | ✓       |                    | LT009                              | ✓                  | YES           | KTARKA120** | 92,00                  | kit |
|                 |             |  | ✓       |                    |                                    |                    |               | TARKA120**  | 66,50                  |     |
| ZX6R / 636      | 19          | 20                                       | ✓       | ✓                  | LT009                              | ✓                  | YES           | KTARKA126** | 92,00                  | kit |
|                 |             |  | ✓       | ✓                  |                                    |                    |               | TARKA126**  | 66,50                  |     |
| ZX10 R          | 08          | 10                                       | ✓       |                    | LT009                              | ✓                  | NO            | KTARKA120** | 92,00                  | kit |
|                 |             |  | ✓       |                    |                                    |                    |               | TARKA120**  | 66,50                  |     |
| ZX10 R          | 11          | 15                                       | —       | —                  | LT009                              | ✓                  | NO            | KTARKA113** | 92,00                  | kit |
|                 |             |  | —       | —                  |                                    |                    |               | TARKA113**  | 66,50                  |     |
| ZX10 R          | 16          | 20                                       | ✓       |                    | LT009                              | ✓                  | YES           | KTARKA121** | 92,00                  | kit |
|                 |             |  | ✓       |                    |                                    |                    |               | TARKA121**  | 66,50                  |     |
| <b>KEEWAY</b>   |             |  |         |                    |                                    |                    |               |             |                        |     |
| RKF 125         | 18          | 20                                       | ✓       |                    | LT009                              | ✓                  | NO            | KTARKE101** | 92,00                  | kit |
|                 |             |  | ✓       |                    |                                    |                    |               | TARKE101**  | 66,50                  |     |



| Modello - Model                | Anno - Year |         | A  |          | B             | C                             | D                      | TÜV homologated | Codice - Code | €   |           |
|--------------------------------|-------------|---------|--|----------|---------------|-------------------------------|------------------------|-----------------|---------------|-----|-----------|
|                                |             |         | foro per frecce<br>hole for turn signals |          | luci<br>light | catadiottro<br>retroreflector | FINA SERIE - END STOCK |                 |               |     |           |
|                                | dal - from  | al - to | racings                                  | original |               |                               |                        |                 |               |     | KBA 91919 |
| <b>KTM</b>                     |             |         |  |          |               |                               |                        |                 |               |     |           |
| DUKE 125 / 390                 | 17          | 20      | ✓  | ✓        | LT009         | ✓                             | YES                    | KTARKT105**     | 113,00        | kit |           |
|                                |             |         | ✓  | ✓        |               |                               |                        | TARKT105**      | 87,00         |     |           |
| DUKE 690                       | 12          | 16      | ✓  |          | LT003         | ✓                             | NO                     | KTARKT103**     | 84,00         | kit |           |
|                                |             |         | ✓  |          | LT003         |                               |                        | TARKT103**      | 80,00         |     |           |
| DUKE 790                       | 18          | 20      | ✓  | ✓        | LT007         | ✓                             | YES                    | KTARKT106**     | 113,00        | kit |           |
|                                |             |         | ✓  | ✓        | LT007         |                               |                        | TARKT106**      | 109,50        |     |           |
| DUKE 890 R                     | 20          | 20      | ✓  | ✓        | LT007         | ✓                             | YES                    | KTARKT106**     | 113,00        | kit |           |
|                                |             |         | ✓  | ✓        | LT007         |                               |                        | TARKT106**      | 109,50        |     |           |
| RC 125 / 200 / 390             | 17          | 20      | ✓  | ✓        | LT009         | ✓                             | NO                     | KTARKT107**     | 113,00        | kit |           |
|                                |             |         | ✓  | ✓        |               |                               |                        | TARKT107**      | 87,00         |     |           |
| Super Duke 1290 - R            | 20          | 20      | ✓  | ✓        | LT009         | ✓                             | YES                    | KTARKT109**     | 207,00        | kit |           |
|                                |             |         | ✓  | ✓        |               |                               |                        | TARKT109**      | 182,00        |     |           |
| <b>MV AGUSTA</b>               |             |         |  |          |               |                               |                        |                 |               |     |           |
| BRUTALE 750 / 910 / 990 / 1090 | 01          | 14      | ✓  |          | LT009         | ✓                             | NO                     | KTARMV101**     | 92,00         | kit |           |
|                                |             |         | ✓  |          |               |                               |                        | TARMV101**      | 66,50         |     |           |
| BRUTALE 675 / 800              | 12          | 16      | ✓  |          | LT009         | ✓                             | NO                     | KTARMV105**     | 92,00         | kit |           |
|                                |             |         | ✓  |          |               |                               |                        | TARMV105**      | 66,50         |     |           |
| F3 675 / F3 800                | 12          | 18      | ✓  |          | LT009         | ✓                             | NO                     | KTARMV104**     | 92,00         | kit |           |
|                                |             |         | ✓  |          |               |                               |                        | TARMV104**      | 66,50         |     |           |
| F4                             | 10          | 12      | ✓  | ✓        | LT009         | ✓                             | NO                     | KTARMV103**     | 95,00         | kit |           |
|                                |             |         | ✓  | ✓        |               |                               |                        | TARMV103**      | 70,00         |     |           |
| F4                             | 13          | 16      | ✓  |          | LT009         | ✓                             | NO                     | KTARMV106**     | 95,00         | kit |           |
|                                |             |         | ✓  |          |               |                               |                        | TARMV106**      | 70,00         |     |           |
| <b>SUZUKI</b>                  |             |         |  |          |               |                               |                        |                 |               |     |           |
| GSR 750                        | 11          | 16      | ✓  |          | LT009         | ✓                             | NO                     | KTARSU110**     | 92,00         | kit |           |
|                                |             |         | ✓  |          |               |                               |                        | TARSU110**      | 66,50         |     |           |
| GSX-R 125 / GSX-S 125          | 17          | 20      | ✓  |          | LT009         | ✓                             | YES                    | KTARSU115**     | 92,00         | kit |           |
|                                |             |         | ✓  |          |               |                               |                        | TARSU115**      | 66,50         |     |           |
| GSX 250 R                      | 17          | 20      | ✓  |          | LT009         | ✓                             | YES                    | KTARSU114**     | 92,00         | kit |           |
|                                |             |         | ✓  |          |               |                               |                        | TARSU114**      | 66,50         |     |           |
| GSXR 600 / 750                 | 08          | 10      | —  | —        | LT009         | ✓                             | NO                     | KTARSU104**     | 92,00         | kit |           |
|                                |             |         | —  | —        |               |                               |                        | TARSU104**      | 66,50         |     |           |
| GSXR 600 / 750                 | 11          | 17      | —  | —        | LT009         | ✓                             | NO                     | KTARSU109**     | 92,00         | kit |           |
|                                |             |         | —  | —        |               |                               |                        | TARSU109**      | 66,50         |     |           |
| GSXR 1000                      | 05          | 08      | —  | —        | LT009         | ✓                             | NO                     | KTARSU101**     | 92,00         | kit |           |
|                                |             |         | —  | —        |               |                               |                        | TARSU101**      | 66,50         |     |           |
| GSXR 1000                      | 09          | 16      | —  | —        | LT009         | ✓                             | YES                    | KTARSU102**     | 92,00         | kit |           |
|                                |             |         | —  | —        |               |                               |                        | TARSU102**      | 66,50         |     |           |
| GSXR 1000 / R                  | 17          | 20      |  | ✓        | LT009         | ✓                             | YES                    | KTARSU113**     | 100,0         | kit |           |
|                                |             |         |  | ✓        |               |                               |                        | TARSU113**      | 74,00         |     |           |
| GSX S 750                      | 17          | 20      | ✓  |          | LT009         | ✓                             | YES                    | KTARSU111**     | 92,00         | kit |           |
|                                |             |         | ✓  |          |               |                               |                        | TARSU111**      | 66,50         |     |           |
| GSX S 1000                     | 15          | 20      | ✓  |          | LT009         | ✓                             | YES                    | KTARSU111**     | 92,00         | kit |           |
|                                |             |         | ✓  |          |               |                               |                        | TARSU111**      | 66,50         |     |           |



| Modello - Model  | Anno - Year |         | A  |               | B                             |          | C        |             | D        |           | TÜV homologated | Codice - Code | € | FINE SERIE - END STOCK |
|--|-------------|---------|--|---------------|-------------------------------|----------|----------|-------------|----------|-----------|-----------------|---------------|---|------------------------|
|  | dal - from  | al - to | foro per frecce<br>hole for turn signals | luci<br>light | catadiottro<br>retroreflector | original | original | original    | original | KBA 91919 |                 |               |   |                        |
| <b>SUZUKI</b>  |             |         |  |               |                               |          |          |             |          |           |                 |               |   |                        |
| SV 650   | 16          | 20      | ✓  |               | LT009                         | ✓        | YES      | KTARSU112** | 92,00    | kit       |                 |               |   |                        |
|  |             |         | ✓  |               |                               |          |          | TARSU112**  | 66,50    |           |                 |               |   |                        |
| <b>TRIUMPH</b>   |             |         |  |               |                               |          |          |             |          |           |                 |               |   |                        |
| DAYTONA 675 / 675R   | 12          | 16      | ✓  | ✓             | LT009                         | ✓        | YES      | KTARTR106** | 95,00    | kit       |                 |               |   |                        |
|  |             |         | ✓  | ✓             |                               |          |          | TARTR106**  | 70,00    |           |                 |               |   |                        |
| Speed Triple 1050 / 1050R  | 11          | 15      | ✓  |               | LT009                         | ✓        | NO       | KTARTR105** | 92,00    | kit       |                 |               |   |                        |
|  |             |         | ✓  |               |                               |          |          | TARTR105**  | 66,50    |           |                 |               |   |                        |
| Speed Triple 1050 / R / RS   | 16          | 20      | ✓  | ✓             | LT009                         | ✓        | YES      | KTARTR107** | 95,00    | kit       |                 |               |   |                        |
| Utilizzare solo frecce corte. Si consiglia modello FRE928<br>Use only short indicators. FRE928NER is recommended |             |         | ✓  | ✓             |                               |          |          | TARTR107**  | 70,00    |           |                 |               |   |                        |
| Street Triple 675 / 675R   | 07          | 12      | ✓  |               | LT009                         | ✓        | NO       | KTARTR103** | 95,00    | kit       |                 |               |   |                        |
|  |             |         | ✓  |               |                               |          |          | TARTR103**  | 70,00    |           |                 |               |   |                        |
| Street Triple 675 / 675R   | 13          | 16      | ✓  | ✓             | LT009                         | ✓        | YES      | KTARTR106** | 95,00    | kit       |                 |               |   |                        |
|  |             |         | ✓  | ✓             |                               |          |          | TARTR106**  | 70,00    |           |                 |               |   |                        |
| Street Triple 765S / 765R / 765RS  | 17          | 21      | ✓  | ✓             | LT009                         | ✓        | YES      | KTARTR106** | 95,00    | kit       |                 |               |   |                        |
|  |             |         | ✓  | ✓             |                               |          |          | TARTR106**  | 70,00    |           |                 |               |   |                        |
| <b>YAMAHA</b>  |             |         |  |               |                               |          |          |             |          |           |                 |               |   |                        |
| FAZER 600 / FZ6  | 04          | 12      | ✓  | ✓             | LT009                         | ✓        | NO       | KTARYA106** | 92,00    | kit       |                 |               |   |                        |
|  |             |         | ✓  | ✓             |                               |          |          | TARYA106**  | 66,50    |           |                 |               |   |                        |
| FZ8  | 10          | 15      | ✓  | ✓             | LT009                         | ✓        | NO       | KTARYA109** | 92,00    | kit       |                 |               |   |                        |
|  |             |         | ✓  | ✓             |                               |          |          | TARYA109**  | 66,50    |           |                 |               |   |                        |
| FAZER 1000 / FZ1   | 06          | 15      | ✓  | ✓             | LT009                         | ✓        | NO       | KTARYA109** | 92,00    | kit       |                 |               |   |                        |
|  |             |         | ✓  | ✓             |                               |          |          | TARYA109**  | 66,50    |           |                 |               |   |                        |
| MT-03  | 15          | 20      | ✓  |               | LT009                         | ✓        | YES      | KTARYA120** | 92,00    | kit       |                 |               |   |                        |
|  |             |         | ✓  |               |                               |          |          | TARYA120**  | 66,50    |           |                 |               |   |                        |
| MT-07  | 13          | 21      | ✓  | ✓             | LT009                         | ✓        | YES      | KTARYA125** | 97,00    | kit       |                 |               |   |                        |
|  |             |         | ✓  | ✓             |                               |          |          | TARYA125**  | 71,50    |           |                 |               |   |                        |
| MT-09  | 13          | 16      | ✓  | ✓             | LT009                         | ✓        | YES      | KTARYA116** | 92,00    | kit       |                 |               |   |                        |
|  |             |         | ✓  | ✓             |                               |          |          | TARYA116**  | 66,50    |           |                 |               |   |                        |
| MT-09 Tracer / Tracer GT   | 15          | 20      | ✓  | ✓             | LT009                         | ✓        | YES      | KTARYA119** | 98,00    | kit       |                 |               |   |                        |
|  |             |         | ✓  | ✓             |                               |          |          | TARYA119**  | 73,00    |           |                 |               |   |                        |
| MT-09  | 17          | 20      | ✓  | ✓             | LT009                         | ✓        | NO       | KTARYA123** | 187,0    | kit       |                 |               |   |                        |
|  |             |         | ✓  | ✓             |                               |          |          | TARYA123**  | 162,0    |           |                 |               |   |                        |
| MT-09  | 21          | 21      | ✓  | ✓             | LT009                         | ✓        | NO       | KTARYA128** | 95,00    | kit       |                 |               |   |                        |
|  |             |         | ✓  | ✓             |                               |          |          | TARYA128**  | 70,00    |           |                 |               |   |                        |
| MT-10  | 16          | 20      | ✓  | ✓             | LT009                         | ✓        | YES      | KTARYA121** | 98,00    | kit       |                 |               |   |                        |
|  |             |         | ✓  | ✓             |                               |          |          | TARYA121**  | 73,00    |           |                 |               |   |                        |
| R 125  | 14          | 18      | ✓  | ✓             | LT009                         | ✓        | NO       | KTARYA126** | 92,00    | kit       |                 |               |   |                        |
|  |             |         | ✓  | ✓             |                               |          |          | TARYA126**  | 66,50    |           |                 |               |   |                        |
| R3   | 15          | 20      | ✓  |               | LT009                         | ✓        | YES      | KTARYA120** | 92,00    | kit       |                 |               |   |                        |
|  |             |         | ✓  |               |                               |          |          | TARYA120**  | 66,50    |           |                 |               |   |                        |
| R6   | 06          | 16      | ✓  | ✓             | LT009                         | ✓        | YES      | KTARYA103** | 92,00    | kit       |                 |               |   |                        |
|  |             |         | ✓  | ✓             |                               |          |          | TARYA103**  | 66,50    |           |                 |               |   |                        |
| R6   | 17          | 20      | ✓  | ✓             | LT009                         | ✓        | YES      | KTARYA122** | 92,00    | kit       |                 |               |   |                        |
|  |             |         | ✓  | ✓             |                               |          |          | TARYA122**  | 66,50    |           |                 |               |   |                        |

NEW!

# PORTA TARGA REGOLABILI

122 ADJUSTABLE LICENSE PLATE HOLDERS

KBA 91919

| Modello - Model                                     | Anno - Year | A  |               | B                             |            | C       |          | D           |        | TÜV homologated | FINE SERIE - END STOCK | Codice - Code | € |
|---|-------------|--|---------------|-------------------------------|------------|---------|----------|-------------|--------|-----------------|------------------------|---------------|---|
|   |             | foro per frecce<br>hole for turn signals | luci<br>light | catadiottro<br>retroreflector | dal - from | al - to | original | racing      |        |                 |                        |               |   |
| <b>YAMAHA</b>                                       |             |  |               |                               |            |         |          |             |        |                 |                        |               |   |
| R1  | 04          | 08                                       | ✓             | ✓                             | LT009      | ✓       | YES      | KTARYA103** | 92,00  | kit             |                        |               |   |
|   |             |  | ✓             | ✓                             |            |         |          | TARYA103**  | 66,50  |                 |                        |               |   |
| R1  | 09          | 14                                       | ✓             | ✓                             | LT009      | ✓       | NO       | KTARYA104** | 92,00  | kit             |                        |               |   |
|   |             |  | ✓             | ✓                             |            |         |          | TARYA104**  | 66,50  |                 |                        |               |   |
| R1 - R1M  | 15          | 20                                       | ✓             | ✓                             | LT009      | ✓       | YES      | KTARYA118** | 180,50 | kit             |                        |               |   |
|   |             |  | ✓             | ✓                             |            |         |          | TARYA118**  | 155,00 |                 |                        |               |   |
| TENERE 700  | 19          | 20                                       | ✓             |                               | LT009      | ✓       | NO       | KTARYA127** | 100,00 | kit             |                        |               |   |
|   |             |  | ✓             |                               |            |         |          | TARYA127**  | 74,00  |                 |                        |               |   |
| XJ6   | 08          | 15                                       | ✓             | ✓                             | LT009      | ✓       | NO       | KTARYA108** | 92,00  | kit             |                        |               |   |
|   |             |  | ✓             | ✓                             |            |         |          | TARYA108**  | 66,50  |                 |                        |               |   |
| T - MAX 500 (con sottocodone / with undertail)      | 08          | 11                                       | —             | —                             | LT009      | ✓       | YES      | KTARYA112** | 117,00 | kit             |                        |               |   |
|   |             |  | —             | —                             |            |         |          | TARYA112**  | 91,50  |                 |                        |               |   |
| T - MAX 500 (senza sottocodone / without undertail) | 08          | 11                                       | —             | —                             | LT009      | ✓       | NO       | KTARYA113** | 92,00  | kit             |                        |               |   |
|   |             |  | —             | —                             |            |         |          | TARYA113**  | 66,50  |                 |                        |               |   |
| T - MAX 530   | 12          | 16                                       | —             | —                             | LT009      | ✓       | YES      | KTARYA114** | 92,00  | kit             |                        |               |   |
|   |             |  | —             | —                             |            |         |          | TARYA114**  | 66,50  |                 |                        |               |   |
| T - MAX 530 / 560                                   | 17          | 20                                       | ✓             | ✓                             | LT009      | ✓       | YES      | KTARYA124** | 92,00  | kit             |                        |               |   |
|   |             |  | ✓             | ✓                             |            |         |          | TARYA124**  | 66,50  |                 |                        |               |   |

## PORTA TARGA UNIVERSALE GENERIC TAIL TIDY TO ADAPT



Porta targa universale con kit di applicazione  
Generic tail tidy to adapt with application kit

colore - color ■

TAR013\*\*

€ 54,00



KTARBM109 = (1) Kit Portatarga + (2) portafaro **nero**  
KTARBM110 = (1) Kit Portatarga + (2) portafaro **silver**

KTARBM109 = (1) Adjustable license plate holder KIT + (2) **Black** light support  
KTARBM110 = (1) Adjustable license plate holder KIT + (2) **Silver** light support

Honda CBR 1000RR - R SP

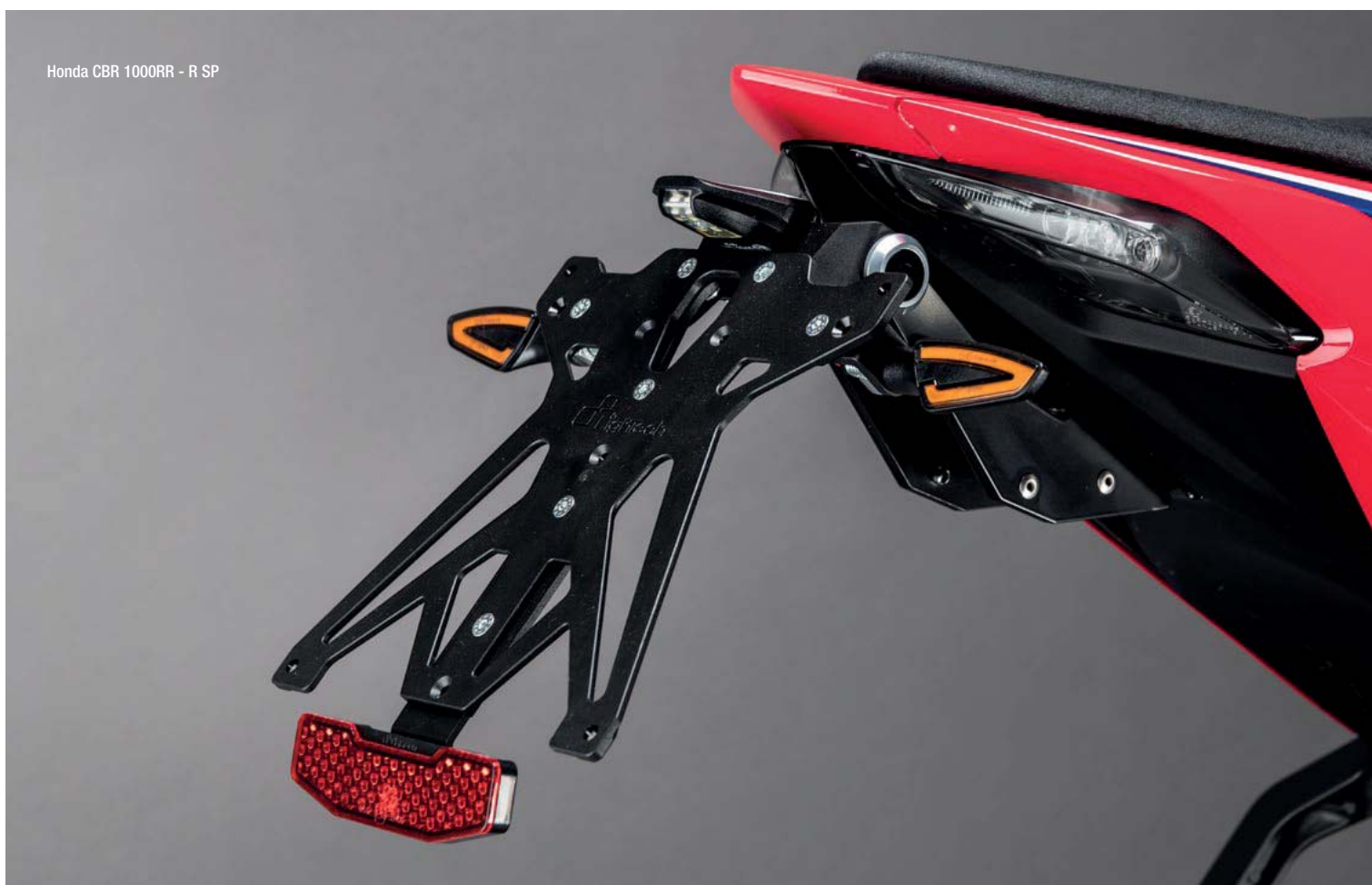

**!** COME COMPORRE IL CODICE / HOW TO FULFILL THE P/N?  
 (esempio per BMW S1000RR con supporto A2 / example for BMW S1000RR with A2 support plate)

Codice KIT porta targa / License plate holder Kit part number + A2 = **KTARBM105A2**

**A1**

-  IT = Italia
-  DE = Deutschland
-  SLO = Slovenija

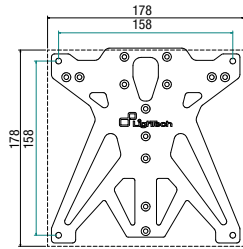

**MATERIAL**

Composit Nylon PA12 + Carbon Fiber

**A2**

-  F = France
-  CH = Schweiz

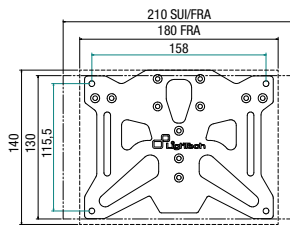

**MATERIAL**

Composit Nylon PA12 + Carbon Fiber

**A3**

-  E = España

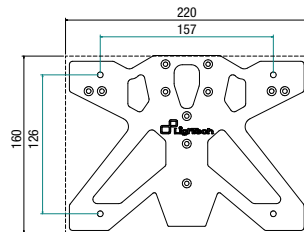

**MATERIAL**

Composit Nylon PA12 + Carbon Fiber

**B1**

-  CA = Canada
-  USA = United S.
-  P = Portugal

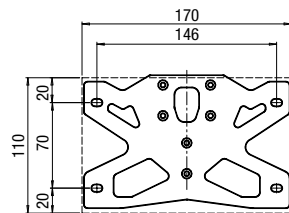

**MATERIAL**

Aluminium

**B2**

-  KOR = Korea

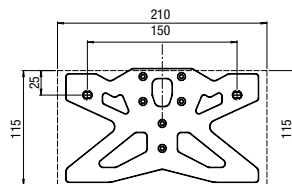

**MATERIAL**

Aluminium

**B3**

-  JAP = Japan

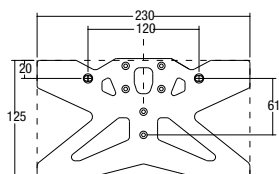

**MATERIAL**

Aluminium

Applicazioni specifiche per portatarga  
Specific applications for license plate holders

Codice - Code

|           |        |
|-----------|--------|
| KTARAP107 | TAR025 |
| KTARAP108 | TAR025 |
| KTARAP109 | TAR025 |
| KTARBM104 | TAR009 |
| KTARBM105 | TAR009 |
| KTARBM111 | TAR025 |
| KTARDU104 | TAR009 |
| KTARDU105 | TAR009 |
| KTARDU106 | TAR009 |
| KTARDU109 | TAR008 |
| KTARDU110 | TAR009 |
| KTARDU112 | TAR029 |
| KTARDU113 | TAR008 |
| KTARDU114 | TAR025 |
| KTARFA101 | TAR025 |
| KTARFA102 | TAR009 |
| KTARGU101 | TAR009 |
| KTARHO107 | TAR009 |
| KTARHO108 | TAR009 |
| KTARHO109 | TAR009 |
| KTARHO110 | TAR009 |
| KTARHO111 | TAR009 |
| KTARHO112 | TAR009 |
| KTARHO113 | TAR009 |
| KTARHO114 | TAR025 |
| KTARHO115 | TAR025 |
| KTARHO116 | TAR025 |
| KTARHO117 | TAR025 |
| KTARHO118 | TAR025 |
| KTARHO119 | TAR025 |
| KTARHO120 | TAR025 |
| KTARHO121 | TAR025 |
| KTARHU101 | TAR009 |
| KTARHU102 | TAR025 |
| KTARKA109 | TAR009 |
| KTARKA113 | TAR008 |
| KTARKA115 | TAR009 |
| KTARKA116 | TAR009 |
| KTARKA117 | TAR009 |
| KTARKA118 | TAR009 |
| KTARKA119 | TAR009 |
| KTARKA120 | TAR009 |
| KTARKA121 | TAR009 |
| KTARKA122 | TAR025 |
| KTARKA123 | TAR025 |
| KTARKA124 | TAR025 |
| KTARKA125 | TAR025 |
| KTARKA126 | TAR025 |

|           |        |
|-----------|--------|
| KTARKE101 | TAR025 |
| KTARKT103 | TAR009 |
| KTARKT105 | TAR025 |
| KTARKT106 | TAR025 |
| KTARKT107 | TAR025 |
| KTARKT109 | TAR008 |
| KTARMV101 | TAR009 |
| KTARMV103 | TAR009 |
| KTARMV104 | TAR025 |
| KTARMV105 | TAR009 |
| KTARMV106 | TAR025 |
| KTARSU101 | TAR009 |
| KTARSU102 | TAR029 |
| KTARSU104 | TAR009 |
| KTARSU109 | TAR009 |
| KTARSU110 | TAR009 |
| KTARSU111 | TAR009 |
| KTARSU112 | TAR009 |
| KTARSU113 | TAR025 |
| KTARSU114 | TAR025 |
| KTARSU115 | TAR025 |
| KTARTR103 | TAR009 |
| KTARTR105 | TAR009 |
| KTARTR106 | TAR025 |
| KTARTR107 | TAR009 |
| KTARYA103 | TAR009 |
| KTARYA104 | TAR009 |
| KTARYA108 | TAR009 |
| KTARYA109 | TAR009 |
| KTARYA112 | TAR009 |
| KTARYA113 | TAR009 |
| KTARYA114 | TAR009 |
| KTARYA116 | TAR025 |
| KTARYA116 | TAR025 |
| KTARYA118 | TAR008 |
| KTARYA119 | TAR025 |
| KTARYA120 | TAR009 |
| KTARYA121 | TAR009 |
| KTARYA122 | TAR025 |
| KTARYA124 | TAR009 |
| KTARYA125 | TAR025 |
| KTARYA126 | TAR025 |
| KTARYA127 | TAR025 |



|                     |                 |         | a kit - for kit |
|---------------------|-----------------|---------|-----------------|
| KIT VITI / BOLT KIT | 005M8x25 + RCM8 | TAR 009 | € 8,00          |
| KIT VITI / BOLT KIT | 005M8x30 + RCM8 | TAR 029 | € 8,00          |
| KIT VITI / BOLT KIT | 005M8x35 + RCM8 | TAR 008 | € 8,00          |
| KIT VITI / BOLT KIT | 005M8x40 + RCM8 | TAR 025 | € 8,00          |

# ACCESSORI PORTA TARGA REGOLABILI

126 ACCESSORIES FOR ADJUSTABLE LICENSE PLATE HOLDERS

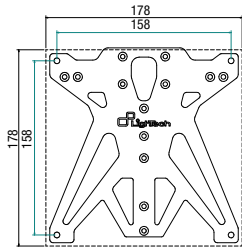

TAR014NER

€ 22,00

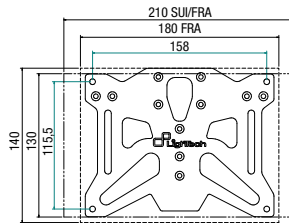

TAR015NER

€ 22,00

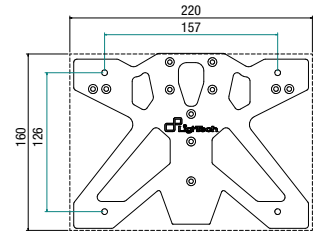

TAR017NER

€ 22,00

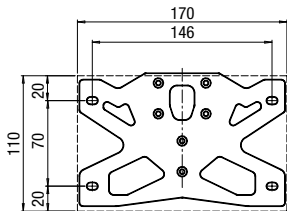

TAR026NER

€ 26,00

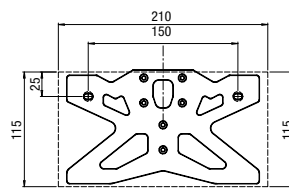

TAR030NER

€ 26,00

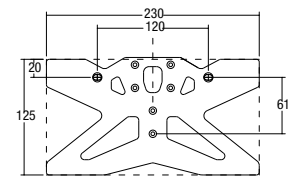

TAR032NER

€ 26,00



Kit supporti frecce aftermarket  
Aftermarket led turn signal  
supports kit

TAR019

€ 6,00



Staffa triangolare  
regolazione inclinazione  
Triangular bracket for  
inclination adjustment

TAR021

€ 9,00



Kit boccole laterali  
Side bushings kit

TAR022

€ 6,00

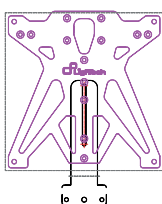

HOMOLOGATED



KAT04

€ 12,00

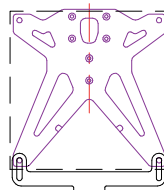

157 mm



HOMOLOGATED



KAT01

€ 12,00



HOMOLOGATED



TAR024

€ 6,50

Compatibile con tutti i portatarga Lightech dal 2019 →  
Compatible with Lightech tail tidy version 2019 →





**LUCI**  
LIGHTS

*Katana*



LUCE SEQUENZIALE / SEQUENTIAL LIGHT

NEW!

**Coppia frecce a led / Pair of led turn signals**

**Materiale / Material:** ABS  
**Omologato / Homologated**

- Nuovi indicatori di direzione / New indicators
- Ligttech patented / Ligttech patented
- Tecnologia innovativa MULTI-PIXEL  
Innovative MULTI-PIXEL technology

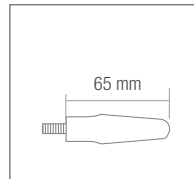

■ **Indicatori di direzione / Indicators**

FRE933NER

a coppia - for pair  
**€ 49,00**

MonsterEye<sup>2</sup>



NEW!

**Coppia frecce a led / Pair of led turn signals**

**Materiale / Material:** ABS  
**Omologato / Homologated**

- Nuovi indicatori di direzione / New indicators
- Ligttech patented / Ligttech patented
- Tecnologia innovativa MULTI-PIXEL  
Innovative MULTI-PIXEL technology

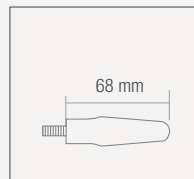

■ **Indicatori di direzione / Indicators**

□ **Front WHITE Light**

FRE934NER

a coppia - for pair  
**€ 52,00**

MonsterEye<sup>3</sup>



**Coppia frecce a led / Pair of led turn signals**

**Materiale / Material:** ABS  
**Omologato / Homologated**

- Nuovi indicatori di direzione / New indicators
- Ligttech patented / Ligttech patented
- Tecnologia innovativa MULTI-PIXEL  
Innovative MULTI-PIXEL technology

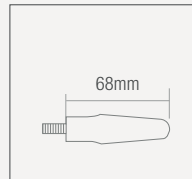

- **Indicatori di direzione / Indicators**
- **Rear RED Light / Brake Light**

FRE935NER

a coppia - for pair

€ 52,00

MonsterEye<sup>1</sup>



**Coppia frecce a led / Pair of led turn signals**

**Materiale / Material:** ABS  
**Omologato / Homologated:** E8

- Nuovi indicatori di direzione / New indicators
- Ligttech patented / Ligttech patented
- Tecnologia innovativa MULTI-PIXEL  
Innovative MULTI-PIXEL technology

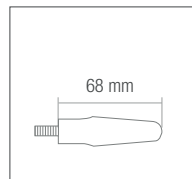

- **Indicatore di direzione / Indicators**

FRE932NER

a coppia - for pair

€ 49,00

SeagullWing



Coppia frecce a led / Pair of led turn signals

Materiale / Material: ABS  
Omologato / Homologated: E8

- Nuovi indicatori di direzione / New indicators
- Lightech patented / Lightech patented
- Tecnologia innovativa MULTI-PIXEL  
Innovative MULTI-PIXEL technology

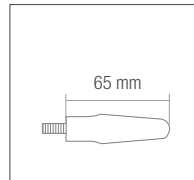

■ Indicatori di direzione / Indicators

FRE931NER

a coppia - for pair  
€ 49,00



FRE931NER



FRE929NER

B52



Coppia frecce a led / Pair of led turn signals

Materiale / Material: ABS  
Omologato / Homologated: E8

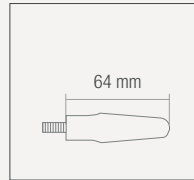

Indicatori di direzione / Indicators

FRE929NER

a coppia - for pair  
€ 49,00

TheTube



Coppia frecce a led / Pair of led turn signals

Materiale / Material: aluminum  
Omologato / Homologated: E8

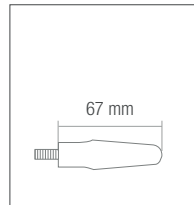

Indicatori di direzione / Indicators

FRE930NER ■  
FRE930COB ■  
FRE930ROS ■

a coppia - for pair  
€ 54,00

FRE930NER



## INDICATORI DI DIREZIONE A LED

132 LED TURN SIGNALS

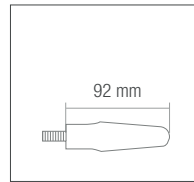

LUCE SEQUENZIALE / SEQUENTIAL LIGHT

**Coppia frecce a led / Pair of led turn signals**

Materiale / Material: ABS  
Omologato / Homologated: E8

- Indicatori di direzione / Indicators
- Stop / Brakelight
- Rear RED Light / Brake Light

FRE923NER

a coppia - for pair

€ 48,00

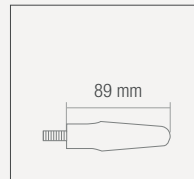

**Coppia frecce a led / Pair of led turn signals**

Materiale / Material: ABS  
Omologato / Homologated: E8

- Indicatori di direzione / Indicators

FRE924NER

a coppia - for pair

€ 38,00



LUCE SEQUENZIALE / SEQUENTIAL LIGHT

**Coppia frecce a led / Led turn signals in pair**

Materiale / Material: ABS  
Omologato / Homologated: E8

- Indicatori di direzione / Indicators

FRE925NER

a coppia - for pair

€ 49,00

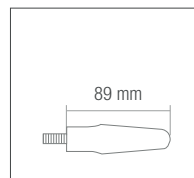

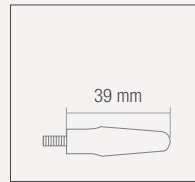

**Coppia frecce a led / Pair of led turn signals**

Materiale / Material: ABS  
Omologato / Homologated: E8

■ **Indicatori di direzione / Indicators**

FRE928NER a coppia - for pair  
**€ 39,00**

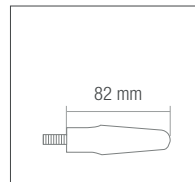

**Coppia frecce a led / Pair of led turn signals**

Materiale / Material: ABS  
Omologato / Homologated: E8

■ **Indicatori di direzione / Indicators**

FRE926NER a coppia - for pair  
**€ 38,00**

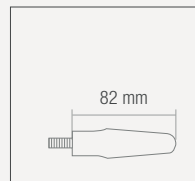

**Coppia frecce a led / Led turn signals in pair**

Materiale / Material: ABS  
Omologato / Homologated: E8

■ **Indicatori di direzione / Indicators**

FRE922NER a coppia - for pair  
**€ 39,00**

## PIASTRINE FRECCE

134 PLATES FOR INDICATORS



Piastrine frecce  
Plates for direction indicators

|     |         |
|-----|---------|
| PFY | € 12,50 |
|-----|---------|

per 4 pezzi  
for 4 pieces



Piastrine frecce  
Plates for direction indicators

|     |         |
|-----|---------|
| PFK | € 12,50 |
|-----|---------|

per 4 pezzi  
for 4 pieces



Piastrine frecce  
Plates for direction indicators

|      |         |
|------|---------|
| PFH2 | € 12,50 |
|------|---------|

per 4 pezzi  
for 4 pieces



Piastrine frecce  
Plates for direction indicators

|     |         |
|-----|---------|
| PFS | € 12,50 |
|-----|---------|

per 4 pezzi  
for 4 pieces



Piastrine frecce  
Plates for direction indicators

|      |         |
|------|---------|
| PFK2 | € 14,50 |
|------|---------|

per 4 pezzi  
for 4 pieces







Nuovo espositore per indicatori di direzione  
New display for turn signals

EXP009

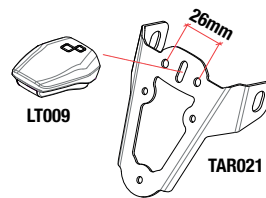

100% MADE IN ITALY  
PATENTED DESIGN®  
HOMOLOGATED



Luce targa Python  
Python license plate light

- LT009BIA
- LT009NER
- LT009ROS
- LT009BLU

€ 30,70

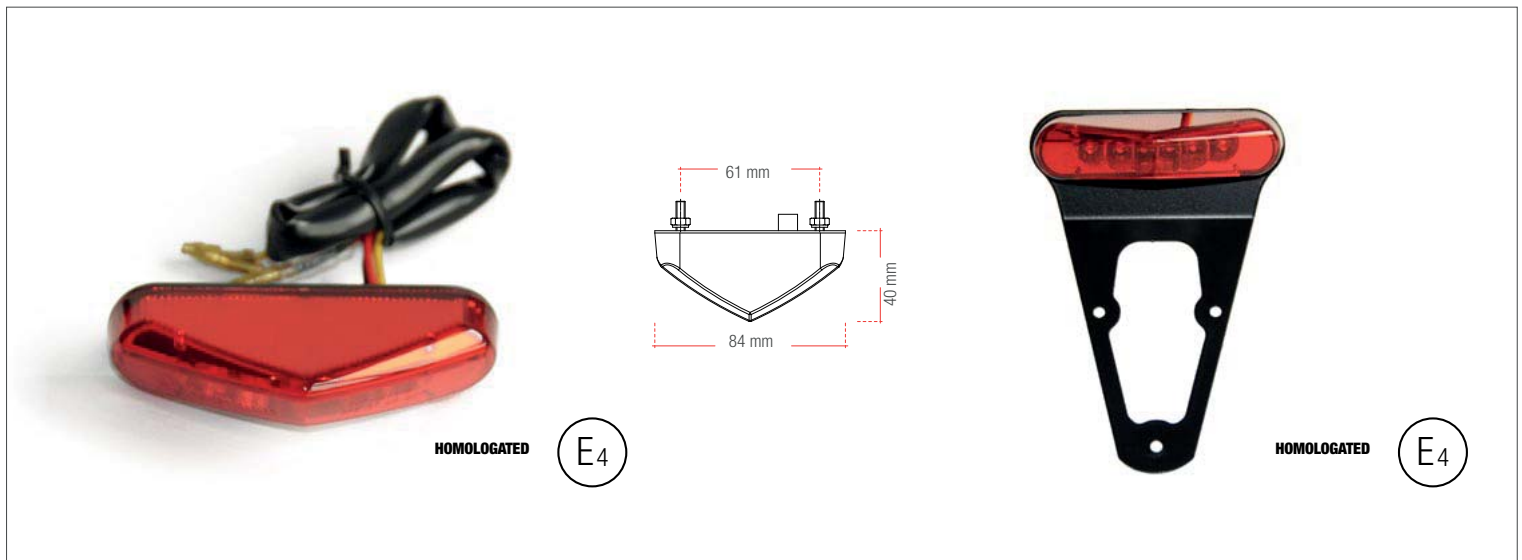

|   |       |         |
|---|-------|---------|
| Faro posteriore con luce targa + STOP<br>Rear light with license plate light + STOP | LT007 | € 36,40 |
|---|-------|---------|

|   |       |         |
|---|-------|---------|
| Faro posteriore con luce targa + STOP<br>Rear light with license plate light + STOP | LT008 | € 46,30 |
|---|-------|---------|

con supporto - with holder

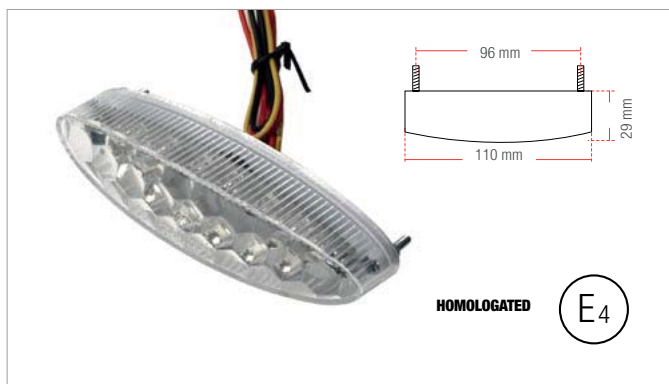

|   |       |         |
|---|-------|---------|
| Faro posteriore con luce targa + STOP<br>Rear light with license plate light + STOP | LT003 | € 33,30 |
|---|-------|---------|

senza copri faro - without cover



|   |        |         |
|---|--------|---------|
| Faro posteriore "RAIN"<br>Rear light "RAIN" | LT 010 | € 65,00 |
|---|--------|---------|

**NOT HOMOLOGATED**



Kit resistenza - Resistor kit  
10W / 6 ohm  
FRE001 € 6,50



Kit resistenza - Resistor kit  
25W / 10 ohm  
FRE002 € 10,00

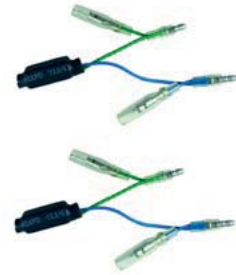

Kit resistenza - Resistor kit  
5W / 22 ohm  
FRE003 € 6,00



Kit resistenza - Resistor kit  
10w - 27 ohm  
21w - 8 ohm  
21 w - 10 ohm  
FRE004 € 7,00  
FRE005 € 7,00



Kit connettori per indicatori di direzione  
(verificare sempre compatibilità) /  
Plugs kit for turn signals (always check  
compatibility)

|          |        |        |
|----------|--------|--------|
| Honda    | FRE006 | € 7,50 |
| Yamaha   | FRE007 | € 7,50 |
| Suzuki   | FRE008 | € 7,50 |
| Kawasaki | FRE009 | € 7,50 |
| BMW      | FRE016 | € 7,50 |
| Triumph  | FRE017 | € 7,50 |



Relè elettronico / Electronic relé  
FRE010 € 14,50  
Intermittenza fissa /  
Fixed intermittence  
12v -180w - 15A



Relè elettronico / Electronic relé  
FRE011 € 22,00  
Intermittenza regolabile /  
Adjustable intermittence  
12v (0,6 -> 180w) - 0,05 - 15A



Kit resistenza - Resistor kit  
FRE012 € 19,50  
Intermittenza fissa /  
Fixed intermittence  
12,8v - (1-> 100w) - 10A



Relè elettronico / Electronic relé  
FRE013 € 17,00  
Intermittenza fissa / Fixed intermittence  
Specifico per / Specific for: Honda  
12,8v / 1 -1 00w



Relè elettronico / Electronic relé  
FRE014 € 12,00  
Intermittenza fissa / Fixed intermittence  
Specifico per / Specific for: Honda Honda, Kawasaki, Yamaha  
12v (0,6v -> 120w) - 0,05 - 10A



Kit resistenza - Resistor kit  
FRE015 € 25,00  
Intermittenza fissa / Fixed intermittence  
Specifico per / Specific for: Suzuki Plug & Play  
(12->13,8v) 1->100w

**BORN  
TO BE  
MOTO**



Yari Montella  
Team SpeedUp

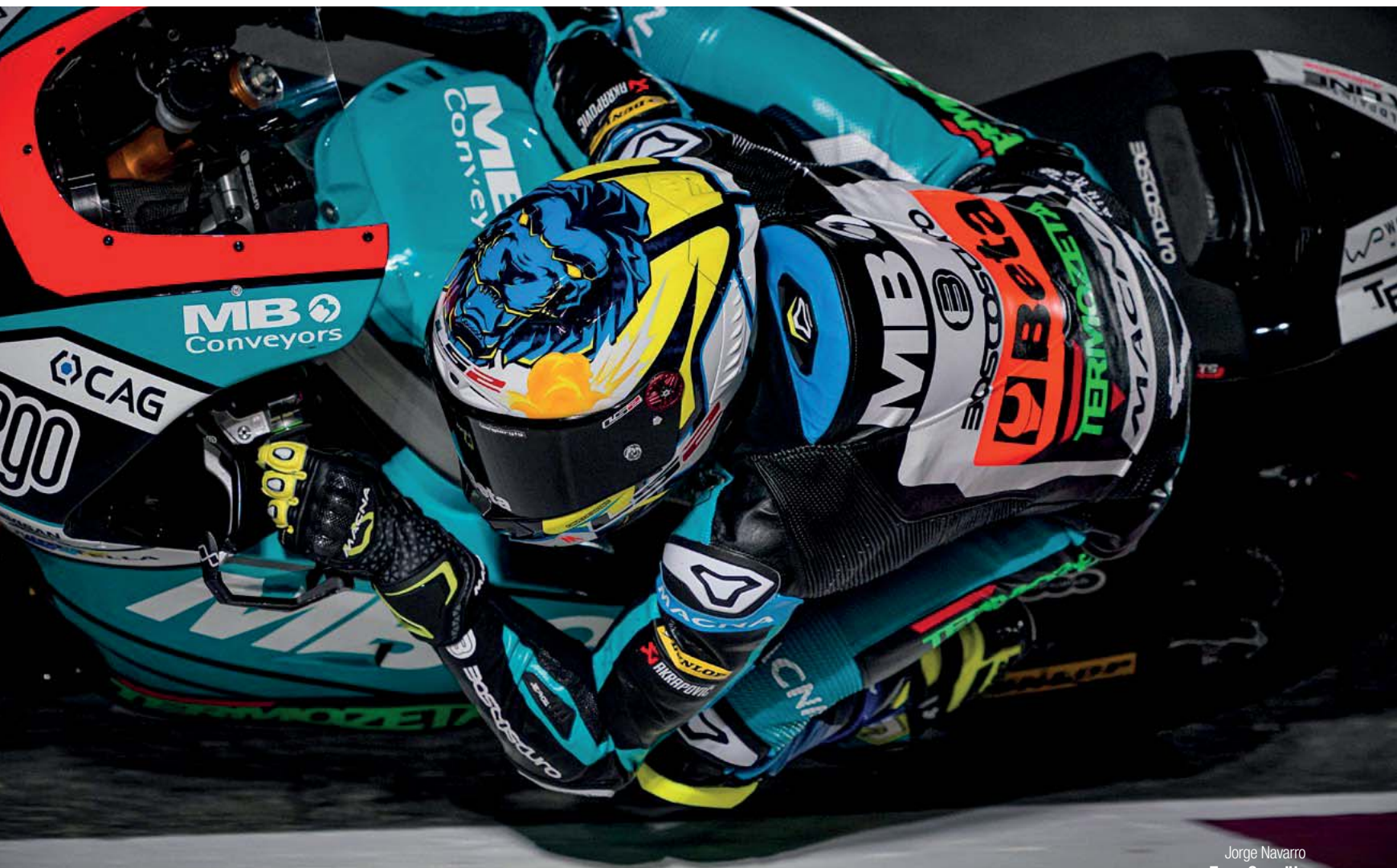

Jorge Navarro  
Team SpeedUp

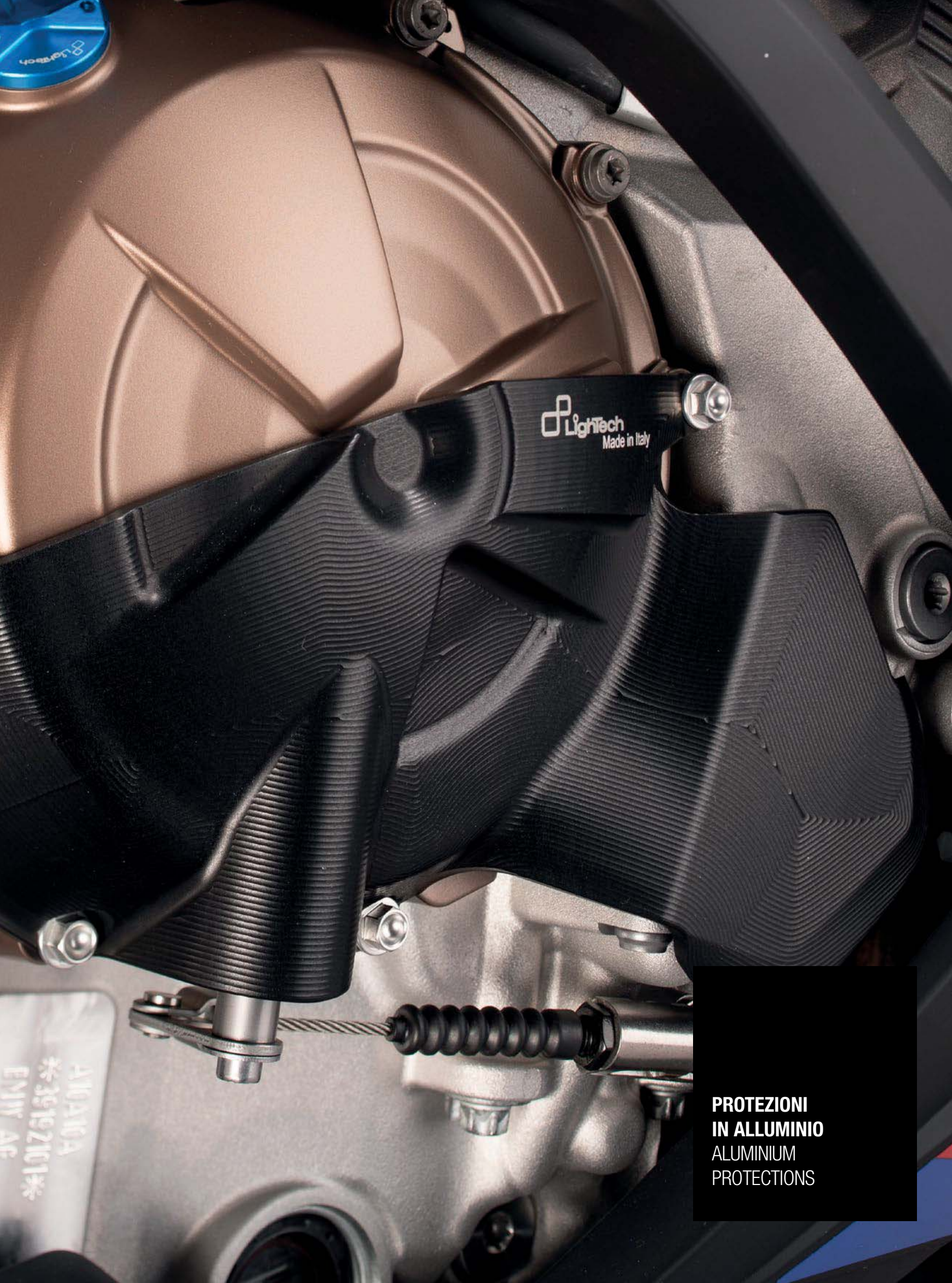

LightTech  
Made in Italy

**PROTEZIONI  
IN ALLUMINIO**  
ALUMINIUM  
PROTECTIONS

410A10A  
\*3916Z101\*  
ENI AC

# PROTEZIONE CARTER

140 CARTER PROTECTOR

FINE SERIE - END STOCK

| Modello - Model                    | Anno - Year | Articolo - Article | Codice - Code                                     | €               |                                      |
|------------------------------------|-------------|--------------------|---|-----------------|--------------------------------------|
| <b>dal - from      al - to</b>     |             |                    |   |                 |                                      |
| <b>APRILIA</b>                     |             |                    |   |                 |                                      |
| RS 660                             | 20          | 21                 | Copri Alternatore lato L / Electric Cover L Side  | ECPAP004        | 115,00                               |
|                                    |             |                    | Copri Frizione lato R / Clutch Cover R Side       | ECPAP003        | 190,00                               |
| RSV4 R / RR / Factory / APRC / RF  | 09          | 20                 | Copri Alternatore lato L / Electric Cover L Side  | ECPAP001        | 102,00                               |
|                                    |             |                    | Copri Frizione lato R / Clutch Cover R Side       | ECPAP002        | 206,00                               |
| TUONO R / RR / Factory / APRC / RF | 11          | 20                 | Copri Alternatore lato L / Electric Cover L Side  | ECPAP001        | 102,00                               |
|                                    |             |                    | Copri Frizione lato R / Clutch Cover R Side       | ECPAP002        | 206,00                               |
| <b>BMW</b>                         |             |                    |   |                 |                                      |
| S 1000 R                           | 09          | 21                 | Copri Alternatore lato L / Electric Cover L Side  | ECPBM001        | 156,00                               |
|                                    |             |                    | Copri Pick Up lato R / Pick Up Cover R Side       | ECPBM003        | 71,00                                |
| S 1000 RR                          | 09          | 18                 | Copri Alternatore lato L / Electric Cover L Side  | ECPBM001        | 156,00                               |
|                                    |             |                    | Copri Pick Up lato R / Pick Up Cover R Side       | ECPBM003        | 71,00                                |
| S 1000 RR                          | 19          | 21                 | Copri Alternatore / Electric Cover                | ECPBM002        | 90,00                                |
|                                    |             |                    | Copri Frizione - Pick Up / Pick Up - Clutch Cover | ECPBM004        | 192,00                               |
| <b>DUCATI</b>                      |             |                    |   |                 |                                      |
| 848 / 1098 / 1198 SBK              | 07          | 11                 | Copri Pompa Acqua / Water Pump Cover              | WPPDU002        | 88,50                                |
| Hypermotard 796 / 1100             | 07          | 12                 | Copri Pompa Acqua / Water Pump Cover              | WPPDU002        | 88,50                                |
| Hypermotard 821 / Hyperstrada 821  | 13          | 16                 | Copri Pignone / Front sprocket cover              | <b>ECPDU004</b> | 78,00                                |
|                                    |             |                    | Copri Pompa Acqua / Water Pump Cover              | WPPDU002        | 88,50                                |
| Hypermotard 939 / 950              | 17          | 21                 | Copri Pompa Acqua / Water Pump Cover              | WPPDU003        | 88,50                                |
| Monster 821                        | 14          | 20                 | Copri Pompa Acqua / Water Pump Cover              | WPPDU003        | 88,50                                |
| Monster 1200                       | 13          | 16                 | Copri Pompa Acqua / Water Pump Cover              | WPPDU002        | 88,50                                |
|                                    |             |                    | 17  | 20              | Copri Pompa Acqua / Water Pump Cover |
| Multistrada 1200                   | 07          | 14                 | Copri Pompa Acqua / Water Pump Cover              | WPPDU002        | 88,50                                |
|                                    |             |                    | 15  | 19              | Copri Pompa Acqua / Water Pump Cover |
| Panigale 1199                      | 12          | 15                 | Copri Alternatore lato L / Electric Cover L Side  | ECPDU001        | 172,00                               |
|                                    |             |                    | Copri Frizione lato R / Clutch Cover R Side       | ECPDU002        | 156,00                               |
| Panigale V4                        | 18          | 21                 | Copri Alternatore lato L / Electric Cover L Side  | ECPDU007        | 172,00                               |
|                                    |             |                    | Copri Frizione lato R / Clutch Cover R Side       | ECPDU006        | 156,00                               |
| Streetfighter 848 / 1100           | 09          | 16                 | Copri Pompa Acqua / Water Pump Cover              | WPPDU002        | 88,50                                |
| Streetfighter V4                   | 20          | 21                 | Copri Alternatore lato L / Electric Cover L Side  | ECPDU007        | 172,00                               |
| <b>HONDA</b>                       |             |                    |   |                 |                                      |
| CBR1000 RR-R / SP                  | 20          | 21                 | Copri Pick Up lato R / Pick Up Cover R Side       | ECPHO006        | 172,00                               |
|                                    |             |                    | Copri Alternatore lato L / Electric Cover L Side  | ECPHO007        | 146,00                               |

NEW!

NEW!

NEW!



ECPAP003



ECPAP001



ECPAP002



ECPBM002



ECPBM004



ECPBM001



ECPBM003



ECPDU006



ECPDU007



WPPDU003

NEW!



ECPH0006

NEW!



ECPH0007



ECPKA001



ECPKA002



ECPMV002

| Modello - Model  | Anno - Year |         | Articolo - Article                               | Codice - Code | €             |
|------------------|-------------|---------|--|---------------|---------------|
|                  | dal - from  | al - to |  |               |               |
| <b>KAWASAKI</b>  |             |         |  |               |               |
| Ninja 300        | 13          | 17      | Copri Alternatore lato L / Electric Cover L Side | ECPKA004      | <b>97,00</b>  |
|                  |             |         | Copri Frizione lato R / Clutch Cover R Side      | ECPKA003      | <b>128,00</b> |
| ZX 10R           | 11          | 20      | Copri Pick Up lato R / Pick Up Cover R Side      | ECPKA001      | <b>102,00</b> |
|                  |             |         | Copri Alternatore lato L / Electric Cover L Side | ECPKA002      | <b>133,00</b> |
| <b>MV AGUSTA</b> |             |         |  |               |               |
| B3 675 / 800     | 12          | 17      | Copri Alternatore lato L / Electric Cover L Side | ECPMV003      | <b>120,00</b> |
|                  |             |         | Copri Frizione lato R / Clutch Cover R Side      | ECPMV004      | <b>151,00</b> |
| F3 675 / 800     | 12          | 17      | Copri Alternatore lato L / Electric Cover L Side | ECPMV003      | <b>120,00</b> |
|                  |             |         | Copri Frizione lato R / Clutch Cover R Side      | ECPMV004      | <b>151,00</b> |
| Dragster 800     | 14          | 17      | Copri Alternatore lato L / Electric Cover L Side | ECPMV003      | <b>120,00</b> |
|                  |             |         | Copri Frizione lato R / Clutch Cover R Side      | ECPMV004      | <b>151,00</b> |
| RIVALE 800       | 14          | 17      | Copri Alternatore lato L / Electric Cover L Side | ECPMV003      | <b>120,00</b> |
|                  |             |         | Copri Frizione lato R / Clutch Cover R Side      | ECPMV004      | <b>151,00</b> |
| <b>SUZUKI</b>    |             |         |  |               |               |
| GSXR 1000        | 17          | 20      | Copri Alternatore lato L / Electric Cover L Side | ECPSU006      | <b>182,00</b> |



ECPSU006



ECPYA008



ECPYA009





ECPYA004



ECPYA005



ECPYA006

| Modello - Model    | Anno - Year |    | Articolo - Article                               | Codice - Code  | €      |
|--------------------|-------------|----|--|--|--------|
| dal - from al - to |             |    |  |  |        |
| <b>YAMAHA</b>      |             |    |  |  |        |
| MT-10              | 16          | 20 | Copri Alternatore lato L / Electric Cover L Side | ECPYA004   | 140,00 |
|                    |             |    | Copri Frizione lato R / Clutch Cover R Side      | ECPYA005   | 151,00 |
|                    |             |    | Copri Pick Up lato R / Pick Up Cover R Side      | ECPYA006   | 99,00  |
| R1 / R1M           | 15          | 21 | Copri Alternatore lato L / Electric Cover L Side | ECPYA004   | 140,00 |
|                    |             |    | Copri Frizione lato R / Clutch Cover R Side      | ECPYA005   | 151,00 |
|                    |             |    | Copri Pick Up lato R / Pick Up Cover R Side      | ECPYA006   | 99,00  |
| R6                 | 06          | 21 | Copri Alternatore lato L / Electric Cover L Side | ECPYA001   | 146,00 |
|                    |             |    | Copri Frizione lato R / Clutch Cover R Side      | ECPYA009   | 170,00 |
|                    |             |    | Copri Pick Up lato R / Pick Up Cover R Side      | ECPYA008   | 120,00 |
| T-MAX 500 - 530    | 06          | 16 | Kit copri carter / Carter cover kit              | STEYA002   | 125,00 |
| T-MAX 530 - 560    | 17          | 21 | Kit copri carter / Carter cover kit              |  ECPYA010 | 192,00 |

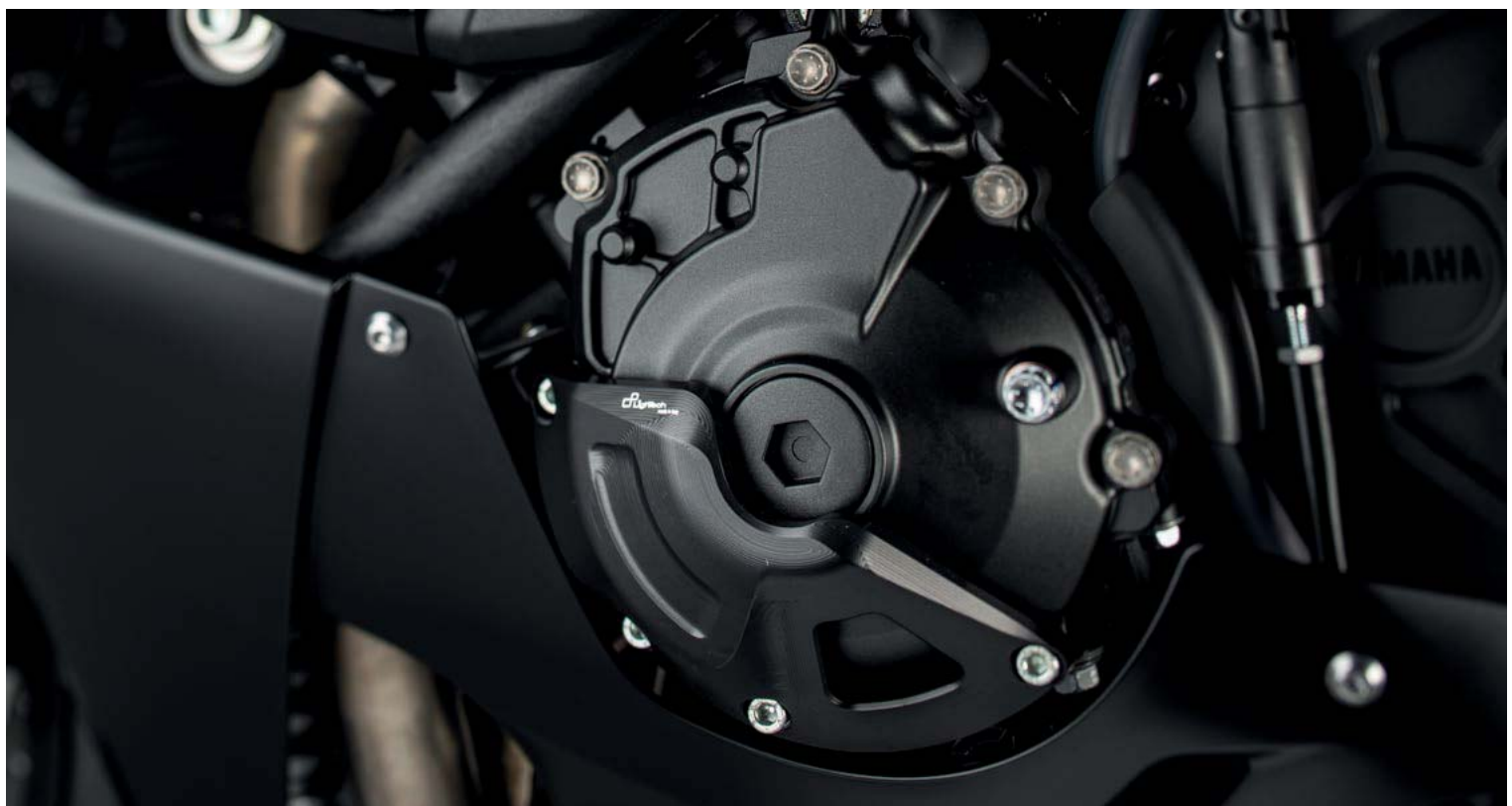

BORN  
TO BE  
MOTO



**PROTEZIONI**  
PROTECTIONS





Anello in alluminio  
Aluminium ring

Boccola per oscillazione in magnesio  
Magnesium bushing for oscillation

Guscio in Nylon  
Nylon shell

Gommino antishock in TPE durezza 60 Shore  
Antishock rubber made of TPE - hardness 60 Shore

Fondo in magnesio  
Magnesium bottom

Colori disponibili: nero. Available colours: black

Right = destro / right Left = sinistra / left ø = foro interno boccola / internal bush hole

FINE SERIE - END STOCK

| Modello - Model  | foro carena - drill fairing | Anno - Year |         | ø mm | Codice - Code | €      |
|--|-----------------------------|-------------|---------|------|---------------|--------|
|  |                             | dal - from  | al - to |      |               |        |
| <b>APRILIA</b>   |                             |             |         |      |               |        |
| DORSODURO 750 / 1200   | /                           | 08          | 17      | 10   | STEAP201      | 77,00  |
| DORSODURO 900  | /                           | 18          | 20      | 10   | STEAP201      | 77,00  |
| RSV4 / Factory / APRC vedi pagina 150 / see page 150           | /                           | 09          | 14      | -    | STEAP104      | 138,00 |
| RSV4 / Factory / APRC vedi pagina 150 / see page 150           | /                           | 09          | 14      | -    | STEAP105      | 138,00 |
| RSV4 / APRC / RF / 1100 factory vedi pagina 150 / see page 150 | /                           | 15          | 20      | -    | STEAP107      | 138,00 |
| SHIVER 750   | /                           | 07          | 16      | 10   | STEAP201      | 77,00  |
| SHIVER 900   | /                           | 18          | 20      | 10   | STEAP201      | 77,00  |
| TUONO V4   | /                           | 11          | 20      | 10   | STEAP203      | 88,00  |
| TUONO V4 vedi pagina 150 / see page 150                        | /                           | 11          | 20      | -    | STEAP106      | 138,00 |
| <b>BENELLI</b>   |                             |             |         |      |               |        |
| LEONCINO   | /                           | 18          | 20      | 10   | STEBN201      | 77,00  |
| <b>BMW</b>   |                             |             |         |      |               |        |
| R nine-T Scrambler   | /                           | 16          | 19      | -    | STEBM207      | 38,00  |
| S1000RR  | /                           | 09          | 11      | 10   | STEBM201      | 75,00  |
| S1000RR / HP4  | /                           | 12          | 14      | 10   | STEBM205      | 95,00  |
| S1000RR  | /                           | 15          | 18      | 10   | STEBM206      | 95,00  |
| S1000RR  | /                           | 19          | 21      | 10   | STEBM208      | 160,00 |
| <b>DUCATI</b>  |                             |             |         |      |               |        |
| HYPERMOTARD 796  | /                           | 09          | 12      | 10   | STEDU205      | 77,00  |
| HYPERMOTARD 821 / HYPERSTRADA 821                              | /                           | 13          | 16      | 10   | STEDU206      | 77,00  |
| MONSTER 696 - 796 - 1100                                       | /                           | 08          | 14      | 10   | STEDU202      | 77,00  |
| SCRAMBLER  | /                           | 14          | 16      | 10   | STEDU207      | 85,00  |
| STREETFIGHTER 848  | /                           | 11          | 16      | 10   | STEDU205      | 77,00  |
| STREETFIGHTER 1100   | /                           | 09          | 15      | 10   | STEDU203      | 77,00  |

FINE SERIE - END STOCK

| Modello - Model    | foro carena - drill fairing | Anno - Year | dal - from | al - to | ø mm | Codice - Code | €      |
|--------------------|-----------------------------|-------------|------------|---------|------|---------------|--------|
| <b>HONDA</b>       |                             |             |            |         |      |               |        |
| CB 500 F           | /                           | 13          | 18         |         | 10   | STEHO213      | 75,00  |
| CB 650 F           | /                           | 17          | 18         |         | 12   | STEHO215      | 75,00  |
| CB 650 R           | /                           | 19          | 21         |         | 12   | STEHO215      | 75,00  |
| CB 1000 R          | /                           | 08          | 20         |         | 12   | STEHO211      | 75,00  |
| CBF 1000           | /                           | 06          | 12         |         | 12   | STEHO211      | 75,00  |
| CBR 600 F          | right / left                | 11          | 13         |         | 12   | STEHO201      | 75,00  |
| CBR 600 RR         | right / left                | 03          | 06         |         | 12   | STEHO201      | 75,00  |
| CBR 600 RR         | right / left                | 09          | 13         |         | 12   | STEHO203      | 75,00  |
| CBR 1000 RR        | /                           | 06          | 07         |         | 10   | STEHO208      | 101,00 |
| CBR 1000 RR        | right / left                | 08          | 16         |         | 12   | STEHO209      | 75,00  |
| CBR 1000 RR-R / SP | /                           | 20          | 21         |         | 12   | STEHO216      | 75,00  |
| HORNET 600         | /                           | 03          | 06         |         | 10   | STEHO204      | 77,00  |
| HORNET 600         | /                           | 07          | 13         |         | 12   | STEHO205      | 75,00  |
| <b>HUSQVARNA</b>   |                             |             |            |         |      |               |        |
| NUDA 900           | /                           | 12          | 15         |         | 12   | STEHU201      | 75,00  |
| <b>KAWASAKI</b>    |                             |             |            |         |      |               |        |
| ER - 6N            | /                           | 12          | 16         |         | 10   | STEKA211      | 103,00 |
| Z125               | /                           | 19          | 20         |         | 10   | STEKA216      | 75,00  |
| Z650               | /                           | 17          | 21         |         | 10   | STEKA214      | 75,00  |
| Z750               | /                           | 04          | 06         |         | 10   | STEKA205      | 75,00  |
| Z750               | /                           | 07          | 12         |         | 10   | STEKA206      | 75,00  |
| Z800               | /                           | 13          | 16         |         | -    | STEKA112NER   | 124,00 |
| Z800               | /                           | 13          | 16         |         | -    | STEKA112SIL   | 124,00 |
| Z800               | /                           | 13          | 16         |         | -    | STEKA112ROS   | 124,00 |
| Z900               | /                           | 17          | 21         |         | 10   | STEKA215      | 75,00  |
| Z1000              | /                           | 03          | 06         |         | 10   | STEKA205      | 75,00  |
| Z1000              | /                           | 07          | 09         |         | 10   | STEKA206      | 75,00  |
| Z1000              | /                           | 10          | 18         |         | 10   | STEKA207      | 75,00  |
| ZX6R               | right / left                | 05          | 06         |         | 10   | STEKA202      | 75,00  |
| ZX6R               | /                           | 07          | 08         |         | 10   | STEKA203      | 88,00  |
| ZX6R / 636         | /                           | 13          | 21         |         | 10   | STEKA213      | 88,00  |
| ZX10R              | left                        | 08          | 10         |         | 10   | STEKA204      | 75,00  |
| ZX10R              | /                           | 11          | 20         |         | 10   | STEKA210      | 77,00  |



FINE SERIE - END STOCK

| Modello - Model                  | foro carena - drill fairing | Anno - Year |         | ø mm | Codice - Code | €      |
|----------------------------------|-----------------------------|-------------|---------|------|---------------|--------|
|                                  |                             | dal - from  | al - to |      |               |        |
| <b>KTM</b>                       |                             |             |         |      |               |        |
| DUKE 125 / 390                   | /                           | 17          | 20      | 10   | STEKT203      | 108,00 |
| DUKE 790                         | /                           | 18          | 20      | 10   | STEKT204      | 108,00 |
| DUKE 890R                        | /                           | 20          | 20      | 10   | STEKT204      | 108,00 |
| <b>MV</b>                        |                             |             |         |      |               |        |
| BRUTALE 675 / 800                | /                           | 12          | 16      | 10   | STEMV202      | 77,00  |
| BRUTALE 800                      | /                           | 17          | 18      | 12   | STEMV203      | 77,00  |
| BRUTALE 750 / 910 / 1000 / 1090  | /                           | 01          | 12      | 13   | STEMV201      | 82,00  |
| DRAGSTER 800                     | /                           | 13          | 16      | 10   | STEMV202      | 77,00  |
| DRAGSTER 800                     | /                           | 17          | 18      | 12   | STEMV203      | 77,00  |
| RIVALE 800                       | /                           | 13          | 16      | 10   | STEMV202      | 77,00  |
| <b>SUZUKI</b>                    |                             |             |         |      |               |        |
| Gladius 650                      | /                           | 09          | 15      | 10   | STESU209      | 85,00  |
| GSR 600                          | /                           | 06          | 11      | 10   | STESU208      | 75,00  |
| GSR 750                          | /                           | 11          | 16      | 10   | STESU211      | 75,00  |
| GSXR 600 / 750                   | /                           | 08          | 10      | 10   | STESU202      | 90,00  |
| GSXR 600 / 750                   | /                           | 11          | 17      | 10   | STESU210      | 103,0  |
| GSXR 1000                        | /                           | 07          | 08      | 10   | STESU205      | 75,00  |
| GSXR 1000                        | /                           | 09          | 16      | 10   | STESU206      | 103,0  |
| GSXR 1000                        | /                           | 17          | 20      | 10   | STESU215      | 134,0  |
| GSX-S 750                        | /                           | 17          | 20      | 10   | STESU214      | 75,00  |
| GSX-S 1000                       | /                           | 15          | 20      | 10   | STESU212      | 75,00  |
| KATANA                           | /                           | 20          | 20      | 10   | STESU212      | 75,00  |
| SV 650                           | /                           | 16          | 17      | 10   | STESU213      | 75,00  |
| <b>TRIUMPH</b>                   |                             |             |         |      |               |        |
| Speed Triple 1050                | /                           | 08          | 10      | 12   | STETR202      | 75,00  |
| Speed Triple 1050                | /                           | 11          | 16      | 12   | STETR204      | 75,00  |
| Street Triple 675 / 675R         | /                           | 07          | 10      | 10   | STETR203      | 75,00  |
| Street Triple 675 / 675R         | /                           | 11          | 16      | 10   | STETR205      | 75,00  |
| Street Triple 765 / 765R / 765RS | /                           | 17          | 21      | 10   | STETR205      | 75,00  |
| <b>YAMAHA</b>                    |                             |             |         |      |               |        |
| FAZER 600 / FZ6                  | /                           | 04          | 12      | 10   | STEYA205      | 75,00  |
| FZ1                              | /                           | 06          | 15      | 10   | STEYA206      | 75,00  |
| FZ8                              | /                           | 10          | 15      | 10   | STEYA206      | 75,00  |
| MT-03                            | /                           | 06          | 14      | 10   | STEYA208      | 101,00 |
| MT-03 ( cc 300)                  | /                           | 15          | 18      | 10   | STEYA217      | 75,00  |
| MT-07                            | /                           | 14          | 20      | 10   | STEYA212      | 75,00  |
| MT-09                            | /                           | 13          | 16      | 10   | STEYA211      | 75,00  |
| MT-09 / SP                       | /                           | 17          | 20      | 10   | STEYA215      | 75,00  |
| MT-09 Tracer / XSR 900           | /                           | 13          | 20      | 10   | STEYA211      | 75,00  |
| MT-10                            | /                           | 16          | 20      | 12   | STEYA213      | 75,00  |
| R1 / R1-M                        | /                           | 15          | 21      | 12   | STEYA213      | 75,00  |
| R3                               | /                           | 15          | 18      | 10   | STEYA214      | 75,00  |
| R6                               | /                           | 06          | 07      | 10   | STEYA203      | 85,00  |
| R6                               | /                           | 08          | 16      | 10   | STEYA204      | 85,00  |
| R6                               | /                           | 17          | 20      | 10   | STEYA216      | 175,00 |



**ANELLI IN ALLUMINIO IN 7 COLORI**  
ALUMINIUM RINGS AVAILABLE IN 7 COLORS



RSTE102ARA

RSTE102ROS

RSTE102ORO

RSTE102VER

RSTE102COB

RSTE102NER

RSTE102SIL

€ 9,20

a coppia - for pair

**GOMMINO SHOCK ABSORBER**  
SHOCK ABSORBER RUBBER



RSTE101ARA

RSTE101BLU

RSTE101ROS

RSTE101VER

RSTE101NER

RSTE101BIA

€ 10,40

a coppia - for pair



**RICAMBIO PER NUOVA "SERIE 200"**  
SPARE PARTS FOR NEW VERSION "200"

a pezzo - for piece

|   |     |         |         |
|---|-----|---------|---------|
| Ricambio protezione - Slider spare part | ø10 | RSTE210 | € 24,50 |
| Ricambio protezione - Slider spare part | ø12 | RSTE212 | € 24,50 |
| Ricambio protezione - Slider spare part | ø13 | RSTE213 | € 24,50 |



\* Controllare posizione vite / Check bolt position

**APRILIA RSV4**

Code: STEAP104

Posizione: alto  
Upper position



Code: STEAP105

Posizione: centrale  
Central position



Code: STEAP107

Posizione: basso  
Lower position



**APRILIA TUONO V4**

Code: STEAP106

Posizione: centrale  
Central position



APRILIA RSV4

STEAP\_---





**PROTEZIONI  
PERNI RUOTA**  
WHEEL AXLE SLIDERS

# PROTEZIONI PERNI RUOTA

152 WHEEL AXLE SLIDERS

## NEW LOOK

- Insetto smart plug  
Smart plug insert
- Combinazioni colori dedicate  
Dedicated color combinations

Maggior protezioni agli urti  
Greater impact protection

Evoluzione delle linee  
Evolution of the lines



|                                    |                                     |                                      |                                     |                                       |                                      |                                       |
|------------------------------------|-------------------------------------|--------------------------------------|-------------------------------------|---------------------------------------|--------------------------------------|---------------------------------------|
| <span style="color: red;">■</span> | <span style="color: blue;">■</span> | <span style="color: black;">■</span> | <span style="color: gold;">■</span> | <span style="color: silver;">■</span> | <span style="color: green;">■</span> | <span style="color: orange;">■</span> |
| rosso<br>red                       | cobalto<br>cobalt                   | nero<br>black                        | oro<br>gold                         | silver<br>silver                      | verde<br>green                       | arancione<br>orange                   |

| Modello - Model                   | Anno - Year | Codice - Code   | €  | Front / Rear | Anno - Year |              | a kit - for kit |
|-----------------------------------|-------------|---|----|--------------|-------------|--------------|-----------------|
|                                   |             |   |    |              | dal - from  | al - to      |                 |
| <b>APRILIA</b>                    |             |   |    |              |             |              |                 |
| DORSODURO 750 / 1200              |             | <span style="color: red;">■</span> <span style="color: black;">■</span> <span style="color: gold;">■</span> <span style="color: silver;">■</span> | 08 | 17           | WAPAP401    | <b>58,00</b> | F+R             |
| DORSODURO 900                     |             | <span style="color: red;">■</span> <span style="color: black;">■</span> <span style="color: gold;">■</span> <span style="color: silver;">■</span> | 18 | 21           | WAPAP401    | <b>58,00</b> | F+R             |
| RSV4 R / Factory / APRC           |             | <span style="color: red;">■</span> <span style="color: black;">■</span> <span style="color: gold;">■</span> <span style="color: silver;">■</span> | 09 | 20           | WAPAP401    | <b>58,00</b> | F+R             |
| SHIVER 750                        |             | <span style="color: red;">■</span> <span style="color: black;">■</span> <span style="color: gold;">■</span> <span style="color: silver;">■</span> | 07 | 16           | WAPAP401    | <b>58,00</b> | F+R             |
| TUONO V4                          |             | <span style="color: red;">■</span> <span style="color: black;">■</span> <span style="color: gold;">■</span> <span style="color: silver;">■</span> | 11 | 20           | WAPAP401    | <b>58,00</b> | F+R             |
| RS 660                            |             | <span style="color: red;">■</span> <span style="color: black;">■</span> <span style="color: gold;">■</span>                                       | 20 | 21           | WAPAP402    | <b>58,00</b> | F+R             |
| <b>BMW</b>                        |             |   |    |              |             |              |                 |
| S1000R                            |             | <span style="color: red;">■</span> <span style="color: black;">■</span> <span style="color: blue;">■</span> <span style="color: silver;">■</span> | 14 | 19           | WAPBM401    | <b>58,00</b> | F+R             |
| S1000RR                           |             | <span style="color: red;">■</span> <span style="color: black;">■</span> <span style="color: blue;">■</span> <span style="color: silver;">■</span> | 09 | 21           | WAPBM401    | <b>58,00</b> | F+R             |
| <b>DUCATI</b>                     |             |   |    |              |             |              |                 |
| DIAVEL                            |             | <span style="color: red;">■</span> <span style="color: black;">■</span>   | 11 | 17           | WAPDU401    | <b>47,50</b> | F               |
| HYPERMOTARD 821 / 939 / 959 / 950 |             | <span style="color: red;">■</span> <span style="color: black;">■</span>   | 13 | 21           | WAPDU403    | <b>33,50</b> | F               |
| MONSTER 821                       |             | <span style="color: red;">■</span> <span style="color: black;">■</span>   | 14 | 16           | WAPDU405    | <b>58,00</b> | F+R             |
| MONSTER 1100                      |             | <span style="color: red;">■</span> <span style="color: black;">■</span>   | 11 | 13           | WAPDU402    | <b>33,50</b> | F               |
| MONSTER 1200 / R                  |             | <span style="color: red;">■</span> <span style="color: black;">■</span>   | 14 | 17           | WAPDU403    | <b>33,50</b> | F               |
| PANIGALE 959                      |             | <span style="color: red;">■</span> <span style="color: black;">■</span>   | 15 | 19           | WAPDU408    | <b>58,00</b> | F+R             |
| PANIGALE 1199                     |             | <span style="color: red;">■</span> <span style="color: black;">■</span>   | 12 | 14           | WAPDU401    | <b>47,50</b> | F               |
|                                   |             |   |    |              | ARDU110     | <b>89,00</b> | R               |
| PANIGALE 1299                     |             | <span style="color: red;">■</span> <span style="color: black;">■</span>   | 15 | 17           | WAPDU409    | <b>47,50</b> | F               |
|                                   |             |   |    |              | ARDU110     | <b>89,00</b> | R               |
| PANIGALE V4                       |             | <span style="color: red;">■</span> <span style="color: black;">■</span>   | 18 | 21           | WAPDU409    | <b>47,50</b> | F               |
|                                   |             |   |    |              | ARDU110     | <b>89,00</b> | R               |
| STREETFIGHTER 848                 |             | <span style="color: red;">■</span> <span style="color: black;">■</span>   | 11 | 16           | WAPDU402    | <b>33,50</b> | F               |
| STREETFIGHTER 1100                |             | <span style="color: red;">■</span> <span style="color: black;">■</span>   | 09 | 15           | WAPDU403    | <b>33,50</b> | F               |
| STREETFIGHTER V4 / S              |             | <span style="color: red;">■</span> <span style="color: black;">■</span>   | 20 | 21           | WAPDU409    | <b>47,50</b> | F               |
|                                   |             |   |    |              | ARDU110     | <b>89,00</b> | R               |



| Modello - Model                 | Anno - Year | Codice - Code | €  | Front / Rear | Anno - Year |         | a kit - for kit |
|---------------------------------|-------------|---------------|----|--------------|-------------|---------|-----------------|
|                                 |             |               |    |              | dal - from  | al - to |                 |
| <b>HONDA</b>                    |             |               |    |              |             |         |                 |
| CB 650 F                        | ■ ■         | 14            | 15 | WAPHO404     | 33,5        | F       |                 |
| CB 1000 R                       | ■ ■         | 18            | 21 | WAPHO407     | 33,5        | F       |                 |
| CBR 600 RR                      | ■ ■         | 07            | 12 | WAPHO401     | 68,00       | F+R     |                 |
| CBR 600 RR                      | ■ ■         | 13            | 13 | WAPHO403     | 68,00       | F+R     |                 |
| CBR 600 RR                      | ■ ■         | 14            | 16 | WAPHO401     | 68,00       | F+R     |                 |
| CBR 1000 RR                     | ■ ■         | 08            | 16 | WAPHO402     | 68,00       | F+R     |                 |
| CBR 1000 RR                     | ■ ■         | 17            | 19 | WAPHO405     | 68,00       | F+R     |                 |
| CBR 1000 RR-R / SP              | ■ ■         | 20            | 21 | WAPHO405     | 68,00       | F+R     |                 |
| XADV                            | ■ ■ ■       | 17            | 20 | WAPHO406     | 68,00       | F+R     |                 |
| <b>KAWASAKI</b>                 |             |               |    |              |             |         |                 |
| ZX6R                            | ■ ■ ■ ■     | 07            | 12 | WAPKA401     | 58,00       | F+R     |                 |
| ZX6R / 636                      | ■ ■ ■ ■     | 13            | 21 | WAPKA405     | 58,00       | F+R     |                 |
| ZX10R                           | ■ ■ ■ ■     | 11            | 20 | WAPKA401     | 58,00       | F+R     |                 |
| Z650                            | ■ ■ ■       | 17            | 21 | WAPKA407     | 58,00       | F+R     |                 |
| Z 800                           | ■ ■ ■       | 13            | 16 | WAPKA406     | 33,50       | F       |                 |
| Z900                            | ■ ■ ■       | 17            | 21 | WAPKA408     | 58,00       | F+R     |                 |
| Z 1000 - SX                     | ■ ■ ■       | 14            | 19 | WAPKA406     | 33,50       | F       |                 |
| <b>KTM</b>                      |             |               |    |              |             |         |                 |
| DUKE 790                        | ■ ■ ■       | 18            | 21 | WAPKT402     | 58,00       | F+R     |                 |
| DUKE 890 R                      | ■ ■ ■       | 20            | 21 | WAPKT402     | 58,00       | F+R     |                 |
| SUPER DUKE 1290                 | ■ ■ ■       | 17            | 19 | WAPKT401     | 33,50       | F       |                 |
| SUPER DUKE 1290 / R             | ■ ■ ■       | 17            | 20 | WAPKT403     | 89,00       | R       |                 |
| <b>MV AGUSTA</b>                |             |               |    |              |             |         |                 |
| BRUTALE                         | ■ ■         | 10            | 16 | WAPMV401     | 33,50       | F       |                 |
|                                 |             |               |    | ARMV102      | 89,00       | R       |                 |
| B3 675 / B3 800                 | ■ ■         | 12            | 16 | WAPMV401     | 33,50       | F       |                 |
|                                 |             |               |    | ARMV102      | 89,00       | R       |                 |
| F3 675 / F3 800                 | ■ ■         | 12            | 16 | WAPMV401     | 33,50       | F       |                 |
|                                 |             |               |    | ARMV102      | 89,00       | R       |                 |
| F4                              | ■ ■         | 10            | 16 | WAPMV401     | 33,50       | F       |                 |
|                                 |             |               |    | ARMV102      | 89,00       | R       |                 |
| RIVALE 800                      | ■ ■         | 14            | 16 | WAPMV401     | 33,50       | F       |                 |
|                                 |             |               |    | ARMV102      | 89,00       | R       |                 |
| <b>SUZUKI</b>                   |             |               |    |              |             |         |                 |
| GSXR 600 / 750                  | ■ ■ ■ ■     | 06            | 10 | WAPSU401     | 68,00       | F+R     |                 |
| GSXR 600 / 750                  | ■ ■ ■       | 11            | 17 | WAPSU402     | 58,00       | F+R     |                 |
| GSXR 1000                       | ■ ■ ■ ■     | 07            | 11 | WAPSU401     | 68,00       | F+R     |                 |
| GSXR 1000                       | ■ ■ ■ ■     | 12            | 21 | WAPSU405     | 58,00       | F+R     |                 |
| GSX-S 750                       | ■ ■ ■       | 17            | 21 | WAPSU406     | 58,00       | F+R     |                 |
| GSX-S 1000                      | ■ ■ ■       | 15            | 21 | WAPSU404     | 58,00       | F+R     |                 |
| <b>TRIUMPH</b>                  |             |               |    |              |             |         |                 |
| DAYTONA 675 / 675R              | ■ ■         | 13            | 13 | WAPTR401     | 58,00       | F+R     |                 |
| STREET TRIPLE 675 / 675R / RS   | ■ ■         | 13            | 16 | WAPTR401     | 58,00       | F+R     |                 |
| STREET TRIPLE 765 S / 765R / RS | ■ ■         | 17            | 21 | WAPTR402     | 33,50       | F       |                 |

# PROTEZIONI PERNI RUOTA

154 WHEEL AXLE SLIDERS

| Modello - Model              | Anno - Year | Codice - Code | €                 | Front / Rear |
|------------------------------|-------------|---------------|-------------------|--------------|
| <b>YAMAHA</b>                |             |               |                   |              |
|                              | dal - from  | al - to       | a kit - for kit   |              |
| MT-07                        | 14          | 20            | WAPYA403<br>33,50 | F            |
|                              |             |               | ARYA104<br>68,00  | R            |
| MT-09 / MT09 TRACER / XSR900 | 13          | 16            | WAPYA402<br>58,00 | F+R          |
| MT-09 / MT09 TRACER GT       | 17          | 20            | WAPYA410<br>58,00 | F+R          |
| MT-10                        | 16          | 20            | WAPYA411<br>58,00 | F+R          |
| R3                           | 15          | 21            | WAPYA413<br>60,00 | F+R          |
| R6                           | 06          | 16            | WAPYA401<br>68,00 | F+R          |
| R6                           | 17          | 20            | WAPYA411<br>58,00 | F+R          |
| R1                           | 07          | 14            | WAPYA401<br>68,00 | F+R          |
| R1 / R1M                     | 15          | 21            | WAPYA411<br>58,00 | F+R          |
| T-Max 500                    | 08          | 11            | WAPYA412<br>33,50 | F            |
| T-Max 530                    | 12          | 14            | WAPYA405<br>58,00 | F+R          |
| T-Max 530 / 560              | 15          | 21            | WAPYA409<br>68,00 | F+R          |

NEW

## RICAMBIO INTERNO PER PROTEZIONI PERNO RUOTA LIGHTECH

REPLACEMENT INTERNAL PART FOR LIGHTECH'S WHEEL AXLE SLIDERS



KWAP001COB

KWAP001ROS

KWAP001VER

KWAP001ORO

KWAP001NER

KWAP001SIL

KWAP001ARA

€ 9,20

a coppia - for pair





**VITERIA  
BOLTS**













**VITI SPECIAL IN ERGAL 7075**

7075 ERGAL SPECIAL BOLTS

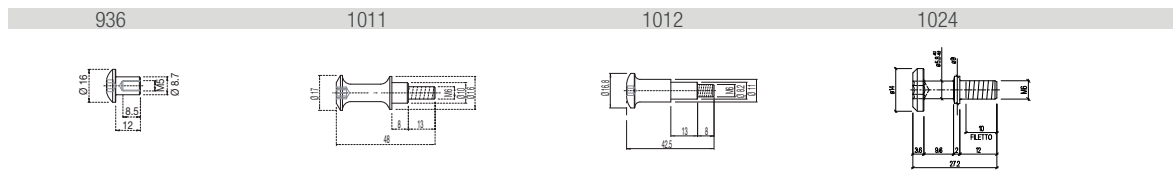
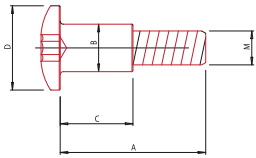

| M  | A    | B    | C    | D  | Codice - Code | €    |
|----|------|------|------|----|---------------|------|
| 8  | 38,5 | 12,4 | 19   | 22 | 930           | 4,90 |
| 10 | 49   | 12,4 | 18,5 | 22 | 931           | 4,90 |
| 10 | 38   | 12,4 | 19   | 22 | 931B          | 4,90 |
| 4  | 12   | -    | -    | 9  | 932           | 1,90 |
| 6  | 19,5 | 7,5  | 3,5  | 14 | 933           | 3,10 |
| 10 | 56,5 | 11,9 | 22,5 | 19 | 934           | 7,30 |
| 8  | 38,5 | 11,9 | 22,5 | 19 | 935           | 6,10 |
| 5  | 12   | 8,7  | 12   | 16 | 936           | 5,60 |
| 6  | 17,4 | 7,9  | 8,4  | 17 | 940           | 3,10 |
| 5  | 15   | 7,4  | 7,5  | 12 | 941           | 2,80 |
| 6  | 20   | -    | -    | 10 | 950           | 3,10 |
| 8  | 31   | 10   | 6    | 17 | 951           | 3,70 |
| 8  | 41   | 9,9  | 6    | 16 | 952           | 4,30 |
| 8  | 20   | 9,9  | 5    | 17 | 953           | 4,30 |
| 6  | 30   | 6    | 9    | 10 | 954           | 3,10 |
| 6  | 23,5 | 9,9  | 11   | 20 | 955           | 4,30 |
| 6  | 15   | -    | -    | 10 | 956           | 3,10 |
| 8  | 33   | 9,9  | 11   | 15 | 960           | 3,70 |
| 10 | 25   | 9,9  | 4    | 15 | 961           | 3,70 |
| 5  | 16,5 | 8,1  | 3,7  | 14 | 962           | 2,80 |
| 6  | 20   | 7,9  | 9,5  | 18 | 963           | 3,10 |
| 7  | 17,5 | 10,9 | 5,5  | 24 | 964           | 3,10 |
| 6  | 15   | 7,9  | 3    | 14 | 965           | 3,10 |
| 4  | 21,5 | 4    | 5,5  | 10 | 970           | 2,50 |
| 4  | 7    | -    | -    | 10 | 971           | 2,20 |

| <b>M</b> | <b>A</b> | <b>B</b> | <b>C</b> | <b>D</b> | <b>Codice - Code</b> | <b>€</b>    |
|----------|----------|----------|----------|----------|----------------------|-------------|
| 6        | 11,5     | 8,2      | 3,75     | 14       | 972                  | <b>2,80</b> |
| 6        | 15       | 9,85     | 5        | 22       | 974                  | <b>3,10</b> |
| 6        | 19       | 7,9      | 8        | 14       | 976                  | <b>3,10</b> |
| 6        | 30,5     | 8        | 23,5     | 14       | 977                  | <b>3,70</b> |
| 6        | 15       | 7,9      | 6        | 14       | 978                  | <b>3,10</b> |
| 6        | 13       | 6,9      | 4,4      | 14       | 979                  | <b>2,50</b> |
| 6        | 14       | 7,9      | 3,8      | 14       | 980                  | <b>3,10</b> |
| 5        | 15,6     | 7,9      | 2,6      | 14       | 981                  | <b>2,80</b> |
| 6        | 16       | 8,4      | 3,5      | 14       | 982                  | <b>3,10</b> |
| 6        | 15       | 7,9      | 6        | 17       | 983                  | <b>3,10</b> |
| 6        | 15       | 8,9      | 4        | 14       | 984                  | <b>3,10</b> |
| 6        | 30       | 6        | 11       | 12       | 991                  | <b>3,10</b> |
| 6        | 11       | 9,9      | 3,5      | 17       | 992                  | <b>2,80</b> |
| 5        | 10       | 8,9      | 3        | 14       | 993                  | <b>2,60</b> |
| 6        | 14,5     | 9,4      | 6        | 17       | 994                  | <b>3,10</b> |
| 6        | 14,5     | 11,9     | 3,5      | 17       | 995                  | <b>3,10</b> |
| 6        | 15       | 8,9      | 5        | 14       | 997                  | <b>3,10</b> |
| 6        | 15       | 9,9      | 3,5      | 17       | 998                  | <b>2,80</b> |
| 5        | 15       | 7        | 2,5      | 11,5     | 999                  | <b>3,10</b> |
| 6        | 15       | 9        | 2        | 14       | 1000                 | <b>3,10</b> |
| 5        | 20,5     | 7        | 13,5     | 12       | 1001                 | <b>3,10</b> |
| 5        | 20,5     | 6,9      | 2,5      | 12       | 1002                 | <b>3,10</b> |
| 6        | 11       | 8,2      | 4        | 14       | 1003                 | <b>3,10</b> |
| 6        | 14       | 7,9      | 5,5      | 14       | 1004                 | <b>5,70</b> |
| 6        | 15       | 9,8      | 5,5      | 22       | 1005                 | <b>2,90</b> |
| 10       | 40       | 10       | 5        | 16       | 1006                 | <b>3,70</b> |
| 6        | 20       | 6        | 1,5      | 30       | 1007                 | <b>4,90</b> |
| 6        | 25,5     | 8        | 13,5     | 17       | 1008                 | <b>3,70</b> |
| 5        | 25       | -        | -        | 9        | 1009                 | <b>3,10</b> |
| 6        | 21       | 10       | 8        | 17       | 1011                 | <b>4,70</b> |
| 6        | 21       | 8,25     | 13       | 17       | 1012                 | <b>4,70</b> |
| 6        | 25,5     | 8        | 10,5     | 24       | 1013                 | <b>4,70</b> |
| 5        | 16       | 8,2      | 8        | 14       | 1015                 | <b>3,10</b> |
| 6        | 16,5     | 8,5      | 3,5      | 17       | 1016                 | <b>3,20</b> |
| 6        | 16,5     | 8,2      | 5        | 12       | 1018                 | <b>3,20</b> |
| 6        | 20       | 9,8      | 8,6      | 17       | 1019                 | <b>3,70</b> |
| 5        | 17       | 8,2      | 5,8      | 14       | 1020                 | <b>3,20</b> |
| 6        | 20       | 8,7      | 9,2      | 14       | 1021                 | <b>3,70</b> |
| 5        | 12,8     | 8,1      | 3,7      | 14       | 1022                 | <b>2,80</b> |
| 5        | 11       | 8        | 2,6      | 14       | 1023                 | <b>3,10</b> |
| 6        | -        | -        | -        | -        | 1024                 | <b>3,80</b> |
|          |          |          |          |          | 1025                 | <b>6,10</b> |
|          |          |          |          |          | 1027                 | <b>2,80</b> |
|          |          |          |          |          | 1028                 | <b>2,80</b> |
| 5        | -        | -        | -        | 10       | 1030                 | <b>2,60</b> |
| 5        | 17       | 7,4      | 5,5      | 12       | 1031                 | <b>2,80</b> |
| 5        | 20       | 7,4      | 9,5      | 12       | 1032                 | <b>2,80</b> |
| 8        | 25       | 11,9     | 10       | 19       | 1033                 | <b>4,30</b> |
| 6        | 16,5     | 8,6      | 3,5      | 17       | 1034                 | <b>3,70</b> |
| 6        | 20       | 8,5      | 10       | 17       | 1035                 | <b>3,70</b> |
| 5        | 13       | 8        | -        | 12       | 1036                 | <b>2,80</b> |
| 5        | 17       | 8,5      | 6        | 12       | 1037                 | <b>2,80</b> |



Viti forate - Drilled bolts

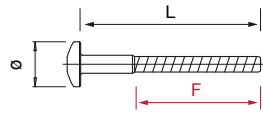

|    | lunghezza - length | ø testa - head | Codice - Code | €    |
|----|--------------------|----------------|---------------|------|
| M5 | 15                 | 12             | FORM515       | 4,90 |
| M5 | 20                 | 12             | FORM520       | 5,00 |
| M6 | 15                 | 17             | FORM615       | 5,70 |
| M6 | 20                 | 17             | FORM620       | 5,80 |
| M6 | 25                 | 17             | FORM625       | 5,90 |
| M6 | 30                 | 17             | FORM630       | 6,00 |
| M8 | 20                 | 22             | FORM820       | 6,10 |
| M8 | 30                 | 22             | FORM830       | 6,40 |
| M8 | 40                 | 22             | FORM840       | 6,60 |
| M8 | 45                 | 22             | FORM845       | 6,70 |



Ergal 7075 / Autofilettanti - Self tapping bolts



PAC 2

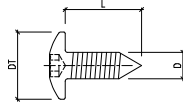

PAC 3

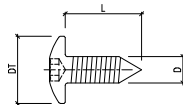

| Ø   | lunghezza - length | ø testa - head | Codice - Code | €    |
|-----|--------------------|----------------|---------------|------|
| 4,5 | 13                 | 10             | PAC24513      | 3,40 |
| 4,5 | 16                 | 10             | PAC24516      | 3,60 |
| 4,9 | 13                 | 10             | PAC24913      | 3,40 |
| 4,9 | 16                 | 10             | PAC24916      | 3,60 |
| 5,5 | 16                 | 10             | PAC25516      | 3,60 |
| 5,5 | 19                 | 10             | PAC25519      | 3,80 |
| 4,5 | 13                 | 14             | PAC34513      | 3,40 |
| 4,5 | 16                 | 14             | PAC34516      | 3,60 |
| 4,9 | 13                 | 14             | PAC34913      | 3,40 |
| 4,9 | 16                 | 14             | PAC34916      | 3,60 |
| 5,5 | 16                 | 14             | PAC35516      | 3,60 |
| 5,5 | 19                 | 14             | PAC35519      | 3,80 |



Ergal 7075 / Ganci rapidi - Quick fairing fasteners

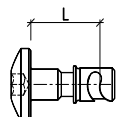

| misura - measure | Codice - Code | €    |
|------------------|---------------|------|
| 11 mm            | GR11          | 5,60 |
| 12 mm            | GR12          | 5,60 |
| 14 mm            | GR14          | 5,90 |
| 16 mm            | GR16          | 6,50 |
| 22 mm            | GR22          | 7,40 |

**Ganci rapidi in acciaio** - Steel quick fairing fasteners

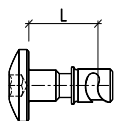

| misura - measure | Codice - Code | €    |
|------------------|---------------|------|
| 11 mm            | GRSTTB11      | 4,90 |
| 12 mm            | GRSTTB12      | 4,90 |
| 14 mm            | GRSTTB14      | 4,90 |

**Ganci rapidi in ferro** - Iron quick fairing fasteners

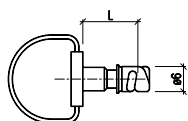

| misura - measure | Codice - Code | €    |
|------------------|---------------|------|
| 11 mm            | GRFE11        | 4,90 |
| 12 mm            | GRFE12        | 4,90 |
| 14 mm            | GRFE14        | 4,90 |

**Ricettacoli** - Receptacle



| Codice - Code | €    |
|---------------|------|
| RIC           | 1,80 |



**Cappelletto valvola ruota** - Wheel valve cap



| Codice - Code | €    |
|---------------|------|
| VAL           | 3,00 |

Viteria ergal 7075 - 7075 ergal bolts



Nm

Ergal 7075

| M3   | M4   | M5   | M6   | M8    | M10   | M12   | M14   | M16   |
|------|------|------|------|-------|-------|-------|-------|-------|
| 0,75 | 1,50 | 3,00 | 5,20 | 12,30 | 25,00 | 42,40 | 67,50 | 102,5 |



| 0011 | M4   | M5   | M6   | M8   | M10 x 1,25 | M10 x 1,5 | M12 x 1,25 |
|------|------|------|------|------|------------|-----------|------------|
| €    | 2,80 | 2,90 | 3,30 | 4,30 | 5,30       | 5,30      | 6,10       |
| 0012 |      |      |      |      | M10 x 1    |           |            |
| €    | -    | -    | -    | -    | 5,30       | -         | -          |
| 0013 |      |      |      |      |            |           | M12 x 1,5  |
| €    | -    | -    | -    | -    | -          | -         | 6,10       |



| 0015 | M4   | M5   | M6   | M8   |   |   |   |
|------|------|------|------|------|---|---|---|
| €    | 2,80 | 2,90 | 3,30 | 4,30 | - | - | - |



| 0016 |   | M5   | M6   | M8   |   |   |   |
|------|---|------|------|------|---|---|---|
| €    | - | 2,90 | 3,30 | 4,30 | - | - | - |



Standard

| misura - measure | Ø est.<br>Ø ext. | spessore - thickness | Codice - Code | €    |
|------------------|------------------|----------------------|---------------|------|
| M4               | 9                | 0,8                  | RM4           | 0,72 |
| M5               | 10               | 1,5                  | RM5           | 0,72 |
| M6               | 12               | 1,6                  | RM6           | 0,72 |
| M8               | 17               | 1,6                  | RM8           | 0,95 |
| M10              | 21               | 2                    | RM10          | 1,05 |



Special

| misura - measure | Ø est.<br>Ø ext. | spessore - thickness | Codice - Code | €    |
|------------------|------------------|----------------------|---------------|------|
| M5               | 17               | 1,6                  | RSM5A         | 0,93 |
| M5               | 21               | 1,6                  | RSM5B         | 0,93 |
| M6               | 17               | 1,6                  | RSM6A         | 0,93 |
| M6               | 21               | 1,6                  | RSM6B         | 1,05 |
| M8               | 21               | 2                    | RSM8A         | 1,05 |
| M10              | 30               | 2                    | RSM10         | 1,60 |

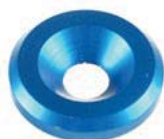

| misura - measure | Ø est.<br>Ø ext. | spessore - thickness | Codice - Code | €    |
|------------------|------------------|----------------------|---------------|------|
| M5               | 15               | 5                    | RCM5          | 1,20 |
| M6               | 22               | 4                    | RCM6          | 1,50 |
| M8               | 25               | 5,5                  | RCM8          | 2,10 |

**Viti in titanium grado 5 - 5th degree titanium bolts**



**Nm**

**TIT. 6AV4V G5**

| M3   | M4   | M5   | M6    | M8    | M10   | M12   | M14    | M16    |
|------|------|------|-------|-------|-------|-------|--------|--------|
| 1,73 | 3,57 | 6,90 | 11,10 | 28,30 | 57,60 | 97,50 | 155,20 | 235,70 |



| T0015 | M4   | M5  | M6  | M8    | M10 x 1,25 | M10 x 1,5 | M12 x 1,25 |
|-------|------|-----|-----|-------|------------|-----------|------------|
| €     | 5,70 | 6,6 | 7,3 | 10,00 | 13,00      | 13,00     | 17,60      |



Standard

| misura - measure | Ø est.<br>Ø ext. | spessore - thickness | Codice - Code | €    |
|------------------|------------------|----------------------|---------------|------|
| M4               | 9                | 0,8                  | RM4T          | 1,80 |
| M5               | 10               | 1,5                  | RM5T          | 2,00 |
| M6               | 12               | 1,6                  | RM6T          | 2,20 |
| M8               | 17               | 1,6                  | RM8T          | 2,80 |
| M10              | 21               | 2                    | RM10T         | 3,30 |

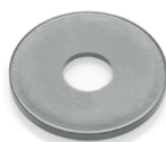

Special

| misura - measure | Ø est.<br>Ø ext. | spessore - thickness | Codice - Code | €    |
|------------------|------------------|----------------------|---------------|------|
| M5               | 17               | 1,6                  | RSM5AT        | 2,80 |
| M6               | 17               | 1,6                  | RSM6AT        | 2,80 |
| M6               | 21               | 1,6                  | RSM6BT        | 3,30 |
| M8               | 21               | 2                    | RSM8AT        | 3,30 |
| M10              | 30               | 2                    | RSM10T        | 5,90 |

**RONDELLE IN NYLON - NYLON WASHERS**



| misura - measure | Ø est.<br>Ø ext. | spessore - thickness | Codice - Code | €    |
|------------------|------------------|----------------------|---------------|------|
| M4               | 10               | 0,5                  | RPM4          | 0,32 |
| M5               | 12               | 0,5                  | RPM5          | 0,32 |
| M6               | 14               | 0,5                  | RPM6          | 0,32 |
| M8               | 16               | 0,5                  | RPM8          | 0,32 |

## VITI DISCHI FRENO IN TITANIO GRADO 5

166 BOLTS FOR BRAKE DISK IN TITANIUM 5 DEGREE

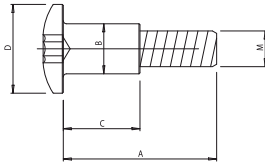
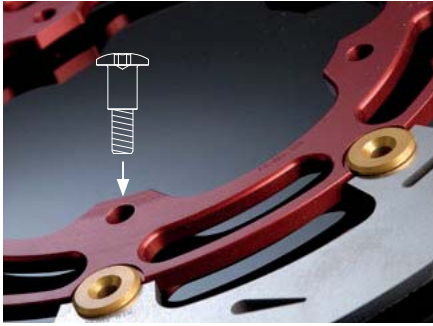

I Modelli di moto citati sono indicativi, pertanto si consiglia di verificare le misure delle viti.

The motorbikes mentioned can be not correct, please control the measures.

FINE SERIE - END STOCK

| moto - bike            | M | A  | B   | C   | D  | Codice - Code | €                   |
|------------------------|---|----|-----|-----|----|---------------|---------------------|
|                        |   |    |     |     |    |               | a pezzo - for piece |
| KAWASAKI               | 8 | 31 | 10  | 5   | 18 | VIT K         | 18,20               |
| SUZUKI                 | 8 | 33 | 10  | 10  | 16 | VIT S         | 17,20               |
| SUZUKI                 | 8 | 21 | 9,9 | 6   | 16 | VIT S2        | 17,20               |
| DUCATI                 | 8 | 15 | -   | -   | 13 | VIT D1        | 10,90               |
| HONDA ANT. / front     | 6 | 20 | -   | -   | 15 | VIT H1        | 14,60               |
| HONDA POST. / rear     | 8 | 23 | 10  | 5   | 16 | VIT H2        | 14,60               |
| HONDA CR. ANT. / front | 6 | 20 | -   | -   | 12 | VIT H3        | 12,00               |
| YAMAHA ANT. / front    | 6 | 21 | 8   | 6   | 14 | VIT Y         | 17,20               |
| YAMAHA POST. / rear    | 8 | 20 | 9,8 | 4,5 | 16 | VIT Y2        | 17,20               |

## RACCORDERIA FRENO BRAKE PARTS

FINE SERIE - END STOCK



| Modello - Model                      | misura - measure | Codice - Code | €    |
|--------------------------------------|------------------|---------------|------|
| Bullone singolo<br>Single banjo bolt | M 10 X 1         | VF11          | 4,60 |
|                                      | M 10 X 1,25      | VF1251        | 4,60 |



| Modello - Model                     | misura - measure | Codice - Code | €    |
|-------------------------------------|------------------|---------------|------|
| Bullone doppio<br>Double banjo bolt | M 10 X 1         | VF12          | 6,25 |
|                                     | M 10 X 1,25      | VF1252        | 6,25 |



| Modello - Model  | misura - measure | Codice - Code | €    |
|--|------------------|---------------|------|
| Bullone singolo con spurgo<br>Single banjo bolt with bleeder | M 10 X 1         | VF11SP        | 5,60 |
|  | M 10 X 1,25      | VF1251SP      | 5,60 |



| Modello - Model   | misura - measure | Codice - Code | €    |
|---|------------------|---------------|------|
| Bullone doppio con spurgo<br>Double banjo bolt with bleeder | M 10 X 1         | VF12SP        | 7,30 |
|   | M 10 X 1,25      | VF1252SP      | 7,30 |



| Modello - Model   | misura - measure | Codice - Code | €    |
|-------------------|------------------|---------------|------|
| Spurgo<br>Bleeder | M6               | SPM6          | 3,15 |
|                   | M7               | SPM7          | 3,50 |
|                   | M8               | SPM8          | 3,70 |
|                   | M 10 x 1         | SPM10         | 4,70 |





**KIT VITI**  
**BOLT KIT**



| Modello<br>Model | MOTORE / ENGINE |                    |                |   | TELAIO / FRAME     |                |   | CARENA / FAIRING   |                |   |
|------------------|-----------------|--------------------|----------------|---|--------------------|----------------|---|--------------------|----------------|---|
|                  | Anno<br>Years   | Quantità<br>Pieces | Codice<br>Code | € | Quantità<br>Pieces | Codice<br>Code | € | Quantità<br>Pieces | Codice<br>Code | € |

dal - from    al - to

| <b>APRILIA</b>                |    |    |    |       |       |    |       |       |    |       |        |
|-------------------------------|----|----|----|-------|-------|----|-------|-------|----|-------|--------|
| DORSODURO 750                 | 08 | 16 | 24 | 9AD M | 40,50 | 29 | 9AD T | 72,10 | 31 | 9AD C | 76,00  |
| DORSODURO 1200                | 11 | 16 | 26 | 1AD M | 61,40 | 25 | 1AD T | 70,10 | 36 | 1AD C | 90,40  |
| RS 660                        | 20 | 21 | -  | -     | -     | -  | -     | -     | -  | -     | -      |
| RSV 1000 R                    | 05 | 08 | 56 | 5A1 M | 116,6 | 33 | 5A1 T | 88,20 | 67 | 5A1 C | 130,90 |
| RSV 4 R / Factory / APRC / RF | 09 | 20 | 30 | 9A4 M | 67,10 | 22 | 9A4 T | 65,60 | 44 | 9A4 C | 94,60  |
| SHIVER                        | 07 | 12 | 38 | 7A7 M | 93,50 | 27 | 7A7 T | 68,40 | 42 | 7A7 C | 102,40 |
| TUONO V4                      | 11 | 20 | 34 | 1AT M | 73,30 | 28 | 1AT T | 87,60 | 42 | 1AT C | 96,90  |

| <b>BMW</b> |    |    |    |       |       |    |       |       |    |       |        |
|------------|----|----|----|-------|-------|----|-------|-------|----|-------|--------|
| S 1000 R   | 14 | 14 | 38 | 4BS M | 93,40 | 25 | 4BS T | 76,10 | 50 | 4BS C | 118,10 |
| S 1000 RR  | 09 | 14 | 38 | 0B1 M | 93,40 | 23 | 0B1 T | 51,20 | 66 | 0B1 C | 134,80 |
| S 1000 RR  | 15 | 18 | 34 | 5B1 M | 83,30 | 19 | 5B1 T | 58,30 | 63 | 5B1 C | 196,80 |
| S 1000 RR  | 19 | 20 | 19 | 9B1 M | 47,30 | 14 | 9B1 T | 50,80 | 23 | 9B1 C | 65,00  |

| <b>DUCATI</b>                 |    |    |    |       |       |    |       |       |    |       |        |
|-------------------------------|----|----|----|-------|-------|----|-------|-------|----|-------|--------|
| 848                           | 08 | 12 | 24 | 8D8 M | 43,40 | 16 | 8D8 T | 38,40 | 77 | 8D8 C | 176,20 |
| 1098 - 1198                   | 07 | 11 | 26 | 7D1M  | 45,10 | 20 | 7D1 T | 45,90 | 73 | 7D1 C | 165,70 |
| DIAVEL                        | 11 | 16 | 35 | 2DD M | 85,70 | 23 | 2DD T | 67,40 | 42 | 2DD C | 88,80  |
| DS 1200 MULTISTRADA           | 10 | 12 | 34 | 0D1 M | 58,60 | 23 | 0D1 T | 61,80 | 76 | 0D1 C | 158,90 |
| HYPERMOTARD 1100              | 07 | 12 | 34 | 7DM M | 58,50 | 24 | 7DM T | 50,90 | 31 | 7DM C | 79,20  |
| HYPERMOTARD 821 / HYPERMOTARD | 13 | 15 | 44 | 3DH M | 75,60 | 21 | 3DH T | 64,50 | 54 | 3DH C | 129,80 |
| MONSTER 696                   | 08 | 13 | 42 | 8D6 M | 81,50 | 14 | 8D6 T | 52,10 | 47 | 8D6 C | 95,40  |
| MONSTER 821                   | 14 | 17 | 48 | 4D8 M | 84,60 | 12 | 4D8 T | 42,80 | 41 | 4D8 C | 86,50  |
| MONSTER 1100                  | 11 | 13 | 39 | 1DM M | 68,10 | 20 | 1DM T | 58,00 | 38 | 1DM C | 70,60  |
| MONSTER 1200 / R              | 17 | 20 | 41 | 1D7 M | 91,85 | 12 | 1D7 T | 42,70 | 42 | 1D7 C | 87,35  |
| PANIGALE 1199 / 1199 R        | 12 | 14 | 24 | 2DP M | 44,60 | 24 | 2DP T | 64,10 | 62 | 2DP C | 137,40 |
| PANIGALE 1299 / 1299 R        | 15 | 17 | 16 | 6D1 M | 36,60 | 20 | 6D1 T | 56,20 | 73 | 6D1 C | 156,70 |
| STREETFIGHTER 848             | 11 | 14 | 42 | 1D8 M | 76,40 | 17 | 1D8 T | 65,70 | 73 | 1D8 C | 143,60 |
| STREETFIGHTER 1100            | 09 | 14 | 47 | 9DS M | 82,00 | 13 | 9DS T | 38,80 | 70 | 9DS C | 135,50 |

| <b>HONDA</b> |    |    |    |       |       |    |       |        |    |       |        |
|--------------|----|----|----|-------|-------|----|-------|--------|----|-------|--------|
| CB500 F      | 13 | 15 | 34 | 3H5 M | 81,50 | 21 | 3H5 T | 67,40  | 41 | 3H5 C | 101,10 |
| CB650 F      | 14 | 17 | 25 | 4H6 M | 61,00 | 39 | 4H6 T | 110,00 | 36 | 4H6 C | 89,50  |
| CB 1000 R    | 08 | 17 | 25 | 8HB M | 60,90 | 32 | 8HB T | 96,10  | 31 | 8HB C | 71,70  |
| CB 1000 R    | 18 | 20 | 30 | 1H8 M | 73,6  | 24 | 1H8 T | 77,55  | 29 | 1H8 C | 59,45  |
| CBR 600 F    | 11 | 14 | 21 | 1H6 M | 51,30 | 25 | 1H6 T | 85,60  | 35 | 1H6 C | 81,80  |
| CBR 250 RR   | 11 | 14 | 24 | 2H5 M | 59,10 | 20 | 2H5 T | 53,60  | 34 | 2H5 C | 78,00  |
| CBR 600 RR   | 07 | 08 | 25 | 7H6 M | 60,60 | 27 | 7H6 T | 85,30  | 59 | 7H6 C | 129,80 |
| CBR 600 RR   | 09 | 12 | -  | -     | -     | 30 | 9HC T | 92,20  | 63 | 9HC C | 140,00 |
| CBR 600 RR   | 13 | 16 | 12 | 6H6 M | 30,00 | 32 | 6H6 T | 94,70  | 63 | 6H6 C | 144,00 |
| CBR 1000 RR  | 06 | 07 | 30 | 6H1 M | 76,60 | 24 | 6H1 T | 78,10  | 68 | 6H1 C | 159,00 |
| CBR 1000 RR  | 08 | 11 | 26 | 8H1 M | 63,10 | 26 | 8H1 T | 79,30  | 43 | 8H1 C | 96,70  |
| CBR 1000 RR  | 12 | 14 | 17 | 2HB M | 42,70 | 27 | 2HB T | 86,00  | 48 | 2HB C | 113,20 |
| CBR 1000 RR  | 17 | 19 | 24 | 1H7 M | 58,60 | 28 | 1H7 T | 93,20  | 36 | 1H7 C | 80,50  |
| CRF 450      | 08 | 09 | 37 | 8H4 M | 90,40 | 17 | 8H4 T | 36,10  | 27 | 8H4 C | 62,70  |
| CRF 450      | 10 | 11 | 39 | 0H4 M | 96,50 | 6  | 0H4 T | 16,10  | 38 | 0H4 C | 88,20  |
| HORNET 600   | 07 | 10 | 26 | 7HH M | 63,20 | 27 | 7HH T | 88,50  | 34 | 7HH C | 84,90  |
| HORNET 600   | 11 | 13 | 26 | 1HH M | 63,20 | 25 | 1HH T | 82,40  | 30 | 1HH C | 68,40  |
| INTEGRA 700  | 12 | 13 | -  | -     | -     | 11 | 2H1 T | 45,70  | 29 | 2H1 C | 66,60  |
| NC 700 X     | 12 | 13 | 35 | 3H7 M | 83,20 | 19 | 3H7 T | 68,00  | 28 | 3H7 C | 77,60  |
| XADV 750     | 17 | 20 | -  | -     | -     | 18 | 7H7 T | 65,40  | 24 | 7H7 C | 79,20  |

| <b>HUSQVARNA</b> |    |    |    |       |        |    |       |       |    |       |       |
|------------------|----|----|----|-------|--------|----|-------|-------|----|-------|-------|
| NUDA 900         | 12 | 14 | 45 | 1Q9 M | 103,00 | 18 | 1Q9 T | 58,20 | 37 | 1Q9 C | 78,50 |



| Modello<br>Model  | MOTORE / ENGINE |                    |                |       | TELAIO / FRAME     |                |       | CARENA / FAIRING   |                |       |        |
|-------------------|-----------------|--------------------|----------------|-------|--------------------|----------------|-------|--------------------|----------------|-------|--------|
|                   | Anno<br>Years   | Quantità<br>Pieces | Codice<br>Code | €     | Quantità<br>Pieces | Codice<br>Code | €     | Quantità<br>Pieces | Codice<br>Code | €     |        |
|                   | dal - from      |                    | al - to        |       |                    |                |       |                    |                |       |        |
| <b>KAWASAKI</b>   |                 |                    |                |       |                    |                |       |                    |                |       |        |
| ER-6N             | 09              | 11                 | 33             | 9KR M | 78,20              | 18             | 9KR T | 52,40              | 40             | 9KR C | 91,70  |
| ER-6N             | 12              | 14                 | 33             | 2KR M | 78,20              | 14             | 2KR T | 51,40              | 46             | 2KR C | 95,20  |
| Ninja 250R        | 09              | 12                 | 12             | 9K2 M | 28,80              | 19             | 9K2 T | 81,90              | 52             | 9K2 C | 111,70 |
| * Ninja 300       | 13              | 17                 | 26             | 3K3 M | 62,60              | 27             | 3K3 T | 101,00             | 45             | 3K3C  | 99,50  |
| * Ninja 400       | 18              | 20                 | 27             | 4K8 M | 64,40              | 36             | 4K8 T | 122,35             | 32             | 4K8 C | 66,25  |
| * Z 650           | 17              | 20                 | 33             | 6K7 M | 76,15              | 17             | 6K7 T | 69,30              | 40             | 6K7 C | 82,40  |
| Z 750             | 07              | 12                 | 32             | 7K7 M | 79,20              | 43             | 7K7 T | 142,00             | 38             | 7K7 C | 86,10  |
| Z 800             | 13              | 16                 | 31             | 3K8 M | 76,40              | 22             | 3K8 T | 75,40              | 41             | 3K8 C | 88,90  |
| * Z 900           | 17              | 20                 | 25             | 9K7 M | 61,20              | 19             | 9K7 T | 63,40              | 24             | 9K7 C | 54,50  |
| Z1000             | 07              | 08                 | 42             | 7K1 M | 93,60              | 46             | 7K1 T | 142,70             | 44             | 7K1 C | 97,50  |
| Z1000             | 09              | 09                 | 42             | 9K1 M | 93,60              | 45             | 9K1 T | 144,20             | 50             | 9K1 C | 110,50 |
| Z1000             | 10              | 13                 | 25             | 0KZ M | 60,50              | 41             | 0KZ T | 128,30             | 47             | 0KZ C | 107,20 |
| Z1000             | 14              | 14                 | 26             | 4KZ M | 63,40              | 31             | 4KZ T | 107,30             | 54             | 4KZ C | 108,40 |
| Z1000 SX          | 11              | 13                 | 21             | 1KS M | 51,10              | 46             | 1KS T | 139,80             | 50             | 1KS C | 112,60 |
| ZX6R              | 07              | 08                 | 37             | 7K6 M | 93,30              | 26             | 7K6 T | 93,40              | 64             | 7K6 C | 140,90 |
| ZX6R              | 09              | 12                 | 37             | 9K6 M | 92,90              | 26             | 9K6 T | 91,30              | 58             | 9K6 C | 119,40 |
| ZX6R              | 13              | 16                 | 40             | 6K6 M | 99,90              | 23             | 6K6 T | 88,40              | 62             | 6K6 C | 128,10 |
| ZX10 R            | 04              | 05                 | 32             | 4K1 M | 74,70              | 28             | 4K1 T | 98,90              | 58             | 4K1 C | 122,40 |
| ZX10 R            | 06              | 07                 | 36             | 6K1 M | 85,20              | 35             | 6K1 T | 113,10             | 57             | 6K1 C | 122,50 |
| ZX10 R            | 08              | 10                 | 26             | 8K1 M | 84,60              | 32             | 8K1 T | 105,40             | 54             | 8K1 C | 115,50 |
| * ZX10 R          | 11              | 15                 | 33             | 1K1 M | 77,90              | 33             | 1K1 T | 111,90             | 47             | 1K1 C | 95,00  |
| * ZX10 R          | 16              | 20                 | 25             | 1K6 M | 57,60              | 25             | 1K6 T | 93,30              | 56             | 1K6 C | 118,60 |
| <b>KTM</b>        |                 |                    |                |       |                    |                |       |                    |                |       |        |
| DUKE 125          | 17              | 19                 | 31             | 8M1 M | 74,75              | 23             | 8M1 T | 68,25              | 31             | 8M1 C | 74,75  |
| DUKE 690          | 07              | 10                 | 28             | 7M6 M | 67,90              | 23             | 7M6 T | 55,30              | 26             | 7M6 C | 63,80  |
| DUKE 690          | 12              | 14                 | 27             | 2M6 M | 66,20              | 22             | 2M6 T | 62,10              | 43             | 2M6 C | 76,90  |
| SUPER DUKE 990    | 07              | 10                 | 29             | 7M9 M | 74,30              | 30             | 7M9 T | 71,60              | 21             | 7M9 C | 33,10  |
| <b>MOTO GUZZI</b> |                 |                    |                |       |                    |                |       |                    |                |       |        |
| GRISO             | 06              | 15                 | 35             | 5GG M | 59,20              | 26             | 5GG T | 58,40              | 47             | 5GG C | 110,30 |
| <b>MV AGUSTA</b>  |                 |                    |                |       |                    |                |       |                    |                |       |        |
| BRUTALE 910       | 04              | 10                 | 35             | MV5 M | 75,60              | 15             | MV5 T | 27,60              | 47             | MV5 C | 90,10  |
| B3 675            | 12              | 16                 | 30             | 4V6 M | 63,10              | 20             | 4V6 T | 48,80              | 37             | 4V6 C | 69,40  |
| B3 800            | 13              | 16                 | 30             | 4V6 M | 63,10              | 20             | 4V6 T | 48,80              | 37             | 4V6 C | 69,40  |
| F3 675            | 12              | 14                 | 20             | MV3 M | 46,00              | 23             | MV3 T | 55,30              | 59             | MV3 C | 125,10 |
| F3 800            | 13              | 16                 | 22             | MV8 M | 49,10              | 20             | MV8 T | 50,20              | 70             | MV8 C | 146,20 |
| F4 1000           | 14              | 14                 | 12             | 4V1 M | 29,80              | 22             | 4V1 T | 63,80              | 37             | 4V1 C | 95,20  |
| RIVALE 800        | 14              | 17                 | 28             | 5M8 M | 63,90              | 26             | 5M8 T | 48,70              | 73             | 5M8 C | 150,40 |
| <b>SUZUKI</b>     |                 |                    |                |       |                    |                |       |                    |                |       |        |
| GLADIUS           | 09              | 13                 | 30             | 9SG M | 77,10              | 20             | 9SG T | 61,70              | 37             | 9SG C | 97,10  |
| GSR 600           | 06              | 11                 | 39             | 6SR M | 99,60              | 26             | 6SR T | 75,50              | 28             | 6SR C | 71,90  |
| GSR 750           | 11              | 13                 | 34             | 1SR M | 85,90              | 27             | 1SR T | 81,60              | 42             | 1SR C | 108,70 |
| GSXR 600/750      | 06              | 07                 | 30             | 6S6 M | 76,90              | 28             | 6S6 T | 79,40              | 47             | 6S6 C | 117,60 |
| GSXR 600/750      | 08              | 10                 | 33             | 8S6 M | 82,60              | 26             | 8S6 T | 71,00              | 48             | 8S6 C | 113,70 |
| GSXR 600/750      | 11              | 16                 | 31             | 1SX M | 79,30              | 38             | 1SX T | 106,90             | 48             | 1SX C | 123,20 |
| GSXR 1000         | 05              | 06                 | 38             | 5S1 M | 92,10              | 38             | 5S1 T | 122,40             | 46             | 5S1 C | 120,20 |
| GSXR 1000         | 07              | 08                 | 32             | 7S1 M | 80,80              | 39             | 7S1 T | 111,00             | 48             | 7S1 C | 134,30 |
| GSXR 1000         | 09              | 16                 | 25             | 9S1 M | 61,50              | 22             | 9S1 T | 69,50              | 49             | 9S1 C | 134,70 |
| GSXR 1000         | 17              | 20                 | 25             | 1X7 M | 61,20              | -              | 1X7 T | 95,20              | 33             | 1X7 C | 80,80  |
| GSX-S 750         | 17              | 20                 | 31             | 7S7 M | 81,10              | -              | 7S7 T | 67,30              | 31             | 7S7 C | 79,80  |
| GSX-S 1000        | 15              | 20                 | 32             | 5SS M | 82,70              | 26             | 5SS T | 82,00              | 39             | 5SS C | 104,10 |



| Modello<br>Model          | MOTORE / ENGINE |                    |                |       | TELAIO / FRAME     |                |       | CARENA / FAIRING   |                |       |        |
|---------------------------|-----------------|--------------------|----------------|-------|--------------------|----------------|-------|--------------------|----------------|-------|--------|
|                           | Anno<br>Years   | Quantità<br>Pieces | Codice<br>Code | €     | Quantità<br>Pieces | Codice<br>Code | €     | Quantità<br>Pieces | Codice<br>Code | €     |        |
|                           | dal - from      | al - to            |                |       |                    |                |       |                    |                |       |        |
| <b>TRIUMPH</b>            |                 |                    |                |       |                    |                |       |                    |                |       |        |
| DAYTONA 675               | 07              | 12                 | 33             | 7TD M | 76,50              | 34             | 7TD T | 98,10              | 46             | 7TD C | 102,80 |
| SPEED TRIPLE 1050         | 08              | 10                 | 55             | 8TT M | 128,80             | 24             | 8TT T | 71,00              | 37             | 8TT C | 88,30  |
| SPEED TRIPLE 1050         | 11              | 15                 | 52             | 0TT M | 122,20             | 33             | 0TT T | 134,60             | 48             | 0TT C | 118,50 |
| SPEED TRIPLE 1050         | 16              | 16                 | 57             | 6T1 M | 132,00             | 24             | 6T1 T | 66,10              | 47             | 6T1 C | 97,00  |
| STREET TRIPLE 675 / 675R  | 07              | 12                 | 36             | 7T6 M | 83,10              | 29             | 7T6 T | 86,20              | 33             | 7T6 C | 81,50  |
| STREET TRIPLE 675 / 675R  | 13              | 16                 | 38             | 3T6 M | 87,40              | 33             | 3T6 T | 95,20              | 40             | 3T6 C | 91,40  |
| STREET TRIPLE 765 / 765 R | 17              | 20                 | 39             | 7T7M  | 90,50              | 28             | 7T7T  | 81,40              | 34             | 7T7C  | 70,00  |

|                     |    |    |    |       |       |    |       |        |    |       |        |
|---------------------|----|----|----|-------|-------|----|-------|--------|----|-------|--------|
| <b>YAMAHA</b>       |    |    |    |       |       |    |       |        |    |       |        |
| FAZER 600 / FZ6 600 | 04 | 12 | 40 | 4Y6 M | 69,50 | 24 | 4Y6 T | 76,80  | 38 | 4Y6 C | 83,50  |
| FZ1                 | 06 | 15 | 35 | 6Y1 M | 77,40 | 22 | 6Y1 T | 71,30  | 58 | 6Y1 C | 131,90 |
| FZ8                 | 10 | 15 | 28 | 0Y8 M | 62,10 | 28 | 0Y8 T | 82,80  | 51 | 0Y8 C | 110,20 |
| MT-03               | 06 | 13 | 30 | 6YM M | 64,50 | 25 | 6YM T | 75,90  | 44 | 6YM C | 94,80  |
| MT-07               | 14 | 20 | 31 | 4Y7 M | 72,10 | 22 | 4Y7 T | 71,20  | 51 | 4Y7 C | 108,50 |
| MT-09               | 13 | 16 | 40 | 3YM M | 93,20 | 18 | 3YM T | 58,50  | 44 | 3YM C | 89,30  |
| MT-09 Tracer        | 15 | 16 | 41 | 5Y9 M | 98,30 | 27 | 5Y9 T | 83,70  | 50 | 5Y9 C | 149,50 |
| MT-09               | 17 | 20 | 39 | 9Y7 M | 92,80 | 18 | 9Y7 T | 70,40  | 33 | 9Y7 C | 85,70  |
| MT-10               | 16 | 20 | 32 | 6Y0 M | 75,70 | 27 | 6Y0 T | 84,00  | 42 | 6Y0 C | 86,60  |
| R1                  | 04 | 06 | 26 | 4Y1 M | 46,20 | 28 | 4Y1 T | 93,50  | 62 | 4Y1 C | 146,10 |
| R1                  | 07 | 08 | 33 | 7Y1 M | 58,60 | 33 | 7Y1 T | 102,80 | 52 | 7Y1 C | 121,00 |
| R1                  | 09 | 14 | 33 | 9Y1 M | 75,80 | 23 | 9Y1 T | 68,10  | 52 | 9Y1 C | 119,50 |
| R1                  | 15 | 19 | 28 | 5Y1 M | 65,95 | 27 | 5Y1 T | 77,75  | 53 | 5Y1 C | 118,90 |
| R1                  | 20 | 20 | 28 | 5Y1 M | 65,95 | 27 | 5Y1 T | 77,75  | 32 | 0Y1 C | 71,30  |
| R3                  | 15 | 17 | 27 | 5Y3 M | 62,60 | 23 | 5Y3 T | 78,80  | 45 | 5Y3 C | 92,50  |
| R6                  | 06 | 07 | 32 | 6Y6 M | 54,70 | 28 | 6Y6 T | 90,90  | 60 | 6Y6 C | 139,60 |
| R6                  | 08 | 16 | 32 | 8Y6 M | 54,70 | 22 | 8Y6 T | 78,10  | 54 | 8Y6 C | 123,90 |
| R6                  | 17 | 20 | 29 | 6Y7 M | 68,50 | 16 | 6Y7 T | 51,10  | 31 | 6Y7 C | 73,30  |
| T MAX 500           | 08 | 11 | 17 | 8YT M | 42,40 | -  | -     | -      | 43 | 8YT C | 108,60 |
| T MAX 530           | 12 | 16 | -  | -     | -     | 16 | 2YXT  | 45,10  | 34 | 2YX C | 82,00  |
| XJ6                 | 08 | 13 | 28 | 8YJ M | 65,20 | 18 | 8YJ T | 61,30  | 48 | 8YJ C | 104,80 |
| X-MAX 400           | 13 | 14 | 15 | 3YX M | 33,50 | -  | -     | -      | 39 | 3YX C | 103,70 |





**DADI SPECIALI**  
SPECIAL NUTS

# DADI SPECIALI ERGAL 7075

172 7075 ERGAL SPECIAL NUTS

Nm = coppia MASSIMA di chiusura / Maximum tightening torque



**D001**  
M 25 X 1,5    30  
Ø 39 · h 13    Nm 350



**D002**  
M 25 X 1    32  
Ø 39,5 · h 14    Nm 300



**D003**  
M 24 X 1,5    32  
Ø 39 · h 17,5    Nm 330



**D004**  
M 18 X 1,5    22  
Ø 29 · h 14    Nm 140



**D005**  
M 22 x 1    32  
Ø 39,5 · h 16,5    Nm 250



**D006**  
M 24 x 1    30  
Ø 37 · h 16,5    Nm 300



**D007**  
M 14 x 1,5    22  
Ø 29,5 · h 13    Nm 67



**D008**  
38 x 1,5    46  
Ø 63,5 · h 28,5    Nm 1240



**D009**  
33 x 1,5    41  
Ø 49,5 · h 14    Nm 900



**D010**  
20 x 1,5    27  
Ø 34,8 · h 15    Nm 200

## POSIZIONE - POSITION

- 1 Perno ruota anteriore / Front wheel axle
- 2 Canotto sterzo / Steering stem head
- 3 Perno forcellone / Swing arm pivot shaft
- 4 Perno ruota posteriore / Rear wheel axle

|                                    |                                     |                                      |                                     |                                       |
|------------------------------------|-------------------------------------|--------------------------------------|-------------------------------------|---------------------------------------|
| <span style="color: red;">■</span> | <span style="color: blue;">■</span> | <span style="color: black;">■</span> | <span style="color: gold;">■</span> | <span style="color: silver;">■</span> |
| rosso<br>red                       | cobalto<br>cobalt                   | nero<br>black                        | oro<br>gold                         | silver<br>silver                      |



| Modello - Model       | Anno - Year | posizione - position 1 |         | posizione - position 2 |       | posizione - position 3 |       | posizione - position 4 |       |               |       |
|-----------------------|-------------|------------------------|---------|------------------------|-------|------------------------|-------|------------------------|-------|---------------|-------|
|                       |             | dal - from             | al - to | Codice - Code          | €     | Codice - Code          | €     | Codice - Code          | €     | Codice - Code | €     |
| <b>APRILIA</b>        |             |                        |         |                        |       |                        |       |                        |       |               |       |
| Dorsoduro 750         | 08 - 13     |                        |         | D001                   | 18,70 | -                      |       | D010                   | 18,70 | D001          | 18,70 |
| Dorsoduro 1200        | 11 - 13     |                        |         | D001                   | 18,70 | -                      |       | D010                   | 18,70 | D001          | 18,70 |
| RSV 1000              | 04 - 05     |                        |         | D001                   | 18,70 | -                      |       | D010                   | 18,70 | D001          | 18,70 |
| RSV4 / Factory / APRC | 09 - 20     |                        |         | D001                   | 18,70 | -                      |       | D010                   | 18,70 | D001          | 18,70 |
| SHIVER 750            | 07 - 13     |                        |         | D001                   | 18,70 | -                      |       | D010                   | 18,70 | D001          | 18,70 |
| Tuono                 | 06 - 09     |                        |         | -                      |       | -                      |       | D010                   | 18,70 | D001          | 18,70 |
| Tuono V4              | 11 - 20     |                        |         | D001                   | 18,70 | -                      |       | D010                   | 18,70 | D001          | 18,70 |
| <b>BMW</b>            |             |                        |         |                        |       |                        |       |                        |       |               |       |
| F800R                 | 10 - 10     |                        |         | -                      |       | -                      |       | -                      |       | D011          | 18,70 |
| S1000R                | 14 - 19     |                        |         | -                      |       | -                      |       | D004                   | 19,30 | D003          | 20,80 |
| S1000RR               | 09 - 21     |                        |         | -                      |       | D014                   | 20,30 | D004                   | 19,30 | D003          | 20,80 |



|                 |        |
|-----------------|--------|
| <b>D011</b>     |        |
| 16 x 1,5        | 🔑 22   |
| ø 25,8 · h 14,5 | Nm 100 |



|                 |        |
|-----------------|--------|
| <b>D013</b>     |        |
| 24 x 1,5        | 🔑 32   |
| ø 39,8 · h 14,5 | Nm 330 |



|                 |        |
|-----------------|--------|
| <b>D014</b>     |        |
| 28 x 1          | 🔑 34   |
| ø 42,3 · h 19,7 | Nm 520 |



|                 |        |
|-----------------|--------|
| <b>D018</b>     |        |
| 22 x 1,5        | 🔑 32   |
| ø 38,4 · h 19,5 | Nm 270 |



|               |        |
|---------------|--------|
| <b>D019</b>   |        |
| 25 x 1,25     | 🔑 28   |
| ø 33,3 · h 10 | Nm 250 |



|             |         |
|-------------|---------|
| <b>D020</b> |         |
| 38 x 1,5    | 🔑 46    |
| ø 55 · h 19 | Nm 1240 |



|             |        |
|-------------|--------|
| <b>D021</b> |        |
| 35 x 1,5    | 🔑 46   |
| ø 55 · h 18 | Nm 960 |



|             |        |
|-------------|--------|
| <b>D022</b> |        |
| 33 x 1      | 🔑 41   |
| ø 46 · h 16 | Nm 850 |



|             |        |
|-------------|--------|
| <b>D023</b> |        |
| 35 x 1,5    | 🔑 46   |
| ø 55 · h 21 | Nm 970 |

| Modello - Model       | Anno - Year | posizione - position 1 | posizione - position 2 | posizione - position 3 | posizione - position 4 |
|-----------------------|-------------|------------------------|------------------------|------------------------|------------------------|
| <b>DUCATI</b>         |             |                        |                        |                        |                        |
| 748 / 916 / 996 / 998 | 96          | 01                     | D019                   | 19,80                  | -                      |
| 848                   | 08          | 11                     | -                      | -                      | D008 (right side)      |
|                       |             |                        |                        |                        | D009 (left side)       |
| HYPERMOTARD 821       | 13          | 14                     | -                      | -                      | D020 (right side)      |
|                       |             |                        |                        |                        | D009 (left side)       |
| Hypermotard 1100      | 07          | 12                     | D019                   | 19,80                  | D008 (right side)      |
|                       |             |                        |                        |                        | D009 (left side)       |
| Monster / 610 ie      | 03          | 07                     | D019                   | 19,80                  | -                      |
| <b>HONDA</b>          |             |                        |                        |                        |                        |
| CB 500 F              | 13          | 13                     | -                      | -                      | D011                   |
| CB 650 F              | 14          | 15                     | -                      | -                      | D004                   |
| CB 1000 R             | 08          | 17                     | -                      | D006                   | D004                   |
| CBR 250 RR            | 11          | 12                     | -                      | -                      | D011                   |
| CBR 600 F             | 11          | 13                     | -                      | D006                   | D004                   |
| CBR 600 RR            | 05          | 06                     | -                      | D006                   | -                      |
| CBR 600 RR            | 07          | 16                     | -                      | D006                   | D004                   |
| CBR 1000 RR           | 04          | 07                     | -                      | -                      | D018                   |
| CBR 1000 RR           | 08          | 16                     | -                      | D022                   | D018                   |
| CBR 1000RR-R / SP     | 20          | 21                     | -                      | -                      | D003                   |
| HORNET 600            | 03          | 06                     | -                      | D006                   | D007                   |
| HORNET 600            | 07          | 13                     | -                      | D006                   | D004                   |
| HORNET 900            | 02          | 08                     | -                      | D006                   | -                      |
| INTEGRA               | 12          | 14                     | -                      | -                      | D004                   |
| NC700X                | 12          | 14                     | -                      | -                      | D004                   |
| XADV                  | 17          | 20                     | -                      | -                      | D004                   |
| <b>HUSQVARNA</b>      |             |                        |                        |                        |                        |
| NUDA 900              | 12          | 15                     | -                      | -                      | D007                   |

# DADI SPECIALI ERGAL 7075

174 7075 ERGAL SPECIAL NUTS

| Modello - Model              | Anno - Year |         | posizione - position 1 |       | posizione - position 2 |       | posizione - position 3 |       | posizione - position 4 |       |
|------------------------------|-------------|---------|------------------------|-------|------------------------|-------|------------------------|-------|------------------------|-------|
|                              | dal - from  | al - to | Codice - Code          | €     | Codice - Code          | €     | Codice - Code          | €     | Codice - Code          | €     |
| <b>KAWASAKI</b>              |             |         |                        |       |                        |       |                        |       |                        |       |
| Ninja 250 R                  | 09          | 12      | D007                   | 18,70 | -                      |       | -                      |       | D011                   | 18,70 |
| Ninja 300 R                  | 13          | 16      | -                      |       | -                      |       | -                      |       | -                      |       |
| ZX6R                         | 03          | 04      | -                      |       | D002                   | 18,70 | D010                   | 18,70 | D003                   | 20,80 |
| ER - 6N                      | 06          | 08      | -                      |       | -                      |       | -                      |       | D004                   | 19,30 |
| ER - 6N                      | 09          | 11      | -                      |       | -                      |       | D010                   | 18,70 | D004                   | 19,30 |
| ER - 6N                      | 12          | 13      | -                      |       | -                      |       | -                      |       | D004                   | 19,30 |
| Z 650                        | 17          | 21      | -                      |       | -                      |       | -                      |       | D004                   | 19,30 |
| Z 750                        | 07          | 12      | -                      |       | -                      |       | D010                   | 18,70 | D004                   | 19,30 |
| Z 800                        | 12          | 16      | -                      |       | -                      |       | -                      |       | D004                   | 19,30 |
| Z 900                        | 17          | 21      | -                      |       | -                      |       | -                      |       | D004                   | 19,30 |
| Z 1000                       | 03          | 06      | -                      |       | -                      |       | D010                   | 18,70 | D003                   | 20,80 |
| Z 1000                       | 07          | 09      | -                      |       | -                      |       | D010                   | 18,70 | D003                   | 20,80 |
| Z 1000 / Z1000 SX            | 10          | 16      | -                      |       | -                      |       | D010                   | 18,70 | -                      |       |
| ZX6R                         | 06          | 21      | -                      |       | D014                   | 20,30 | D010                   | 18,70 | D003                   | 20,80 |
| ZX10R                        | 04          | 05      | -                      |       | D014                   | 20,30 | D010                   | 18,70 | D004                   | 19,30 |
| ZX10 R                       | 06          | 07      | -                      |       | D014                   | 20,30 | D010                   | 18,70 | D004                   | 19,30 |
| ZX10 R                       | 08          | 10      | -                      |       | -                      |       | D010                   | 18,70 | D004                   | 19,30 |
| ZX10 R                       | 11          | 20      | -                      |       | D014                   | 20,30 | D010                   | 18,70 | D003                   | 20,80 |
| <b>MV</b>                    |             |         |                        |       |                        |       |                        |       |                        |       |
| BRUTALE 675 / BRUTALE 800    | 12          | 17      | D019                   | 19,80 | -                      |       | -                      |       | -                      |       |
| F3 675 / F3 800              | 12          | 17      | D019                   | 19,80 | -                      |       | -                      |       | -                      |       |
| RIVALE 800                   | 14          | 17      | D019                   | 19,80 | -                      |       | -                      |       | -                      |       |
| <b>SUZUKI</b>                |             |         |                        |       |                        |       |                        |       |                        |       |
| GLADIUS                      | 09          | 13      | -                      |       | D005                   | 18,70 | -                      |       | D010                   | 18,70 |
| GSR 600                      | 06          | 11      | -                      |       | D013                   | 18,70 | D010                   | 18,70 | D018                   | 20,80 |
| GSR 750                      | 11          | 16      | -                      |       | -                      |       | -                      |       | D018                   | 20,80 |
| GSXR 1000                    | 05          | 16      | -                      |       | D014                   | 20,30 | D010                   | 18,70 | D001                   | 18,70 |
| GSXR 600 / 750               | 06          | 10      | -                      |       | D014                   | 20,30 | D010                   | 18,70 | D001                   | 18,70 |
| GSXR 600 / 750               | 11          | 17      | D010                   | 18,70 | D014                   | 20,30 | D010                   | 18,70 | D018                   | 20,80 |
| GSXS 1000 / GSXS 1000F       | 15          | 19      | D010                   | 18,70 | -                      |       | D010                   | 18,70 | D001                   | 18,70 |
| SV 650 / 650S                | 03          | 08      | -                      |       | D013                   | 18,70 | D004                   | 19,30 | D004                   | 19,30 |
| <b>TRIUMPH</b>               |             |         |                        |       |                        |       |                        |       |                        |       |
| DAYTONA 675 / 675R           | 07          | 16      | -                      |       | D002                   | 18,70 | D011                   | 18,70 | D004                   | 19,30 |
| Speed Triple 1050 / 1050R    | 08          | 16      | -                      |       | -                      |       | -                      |       | D020 (right side)      | 46,80 |
|                              |             |         |                        |       |                        |       |                        |       | D021 (left side)       | 36,40 |
| Street Triple 675 / 675R     | 07          | 16      | -                      |       | D002                   | 18,70 | D011                   | 18,70 | D004                   | 19,30 |
| Street Triple 765 R / S / RS | 17          | 21      | -                      |       | D002                   | 18,70 | D011                   | 18,70 | D004                   | 19,30 |
| <b>YAMAHA</b>                |             |         |                        |       |                        |       |                        |       |                        |       |
| MT-03 (660cc) monocilindrico | 06          | 14      | -                      |       | D005                   | 18,70 | D011                   | 18,70 | D011                   | 18,70 |
| MT-03 (321cc) bicilindrico   | 16          | 18      | -                      |       | -                      |       | -                      |       | D011                   | 18,70 |
| MT-07                        | 13          | 20      | -                      |       | -                      |       | -                      |       | D004                   | 19,30 |
| MT-09 / MT - 09 Tracer       | 13          | 20      | -                      |       | -                      |       | -                      |       | D004                   | 19,30 |
| Fazer 600 / FZ6              | 04          | 12      | -                      |       | D005                   | 18,70 | D004                   | 19,30 | D003                   | 20,80 |
| FZ8                          | 10          | 16      | -                      |       | D014                   | 20,30 | D004                   | 19,30 | D003                   | 20,80 |
| FZ1 / FAZER 1000             | 06          | 12      | -                      |       | D014                   | 20,30 | D004                   | 19,30 | D003                   | 20,80 |
| R6                           | 06          | 20      | -                      |       | D014                   | 20,30 | D018                   | 20,80 | D003                   | 20,80 |
| R1                           | 04          | 06      | -                      |       | D014                   | 20,30 | D004                   | 19,30 | D003                   | 20,80 |
| R1                           | 07          | 14      | -                      |       | D014                   | 20,30 | D010                   | 18,70 | D003                   | 20,80 |
| R1 / R1M                     | 15          | 21      | -                      |       | -                      |       | -                      |       | D003                   | 20,80 |
| R3                           | 15          | 21      | -                      |       | -                      |       | -                      |       | D011                   | 18,70 |
| T-MAX 530                    | 12          | 21      | -                      |       | -                      |       | -                      |       | D013                   | 18,70 |
| XJ6                          | 08          | 12      | -                      |       | D005                   | 18,70 | D007                   | 18,70 | D011                   | 18,70 |



TAPPI  
CAPS

















FILETTATO - SPIN LOCKING











TAPPI COLORATI  
COLOURED CAPS

TAPPI B&W  
B&W CAPS

| Modello - Model | Anno - Year | Codice - Code   | € |
|-----------------|-------------|---|---|
|                 |             |  |   |







| Codice - Code   | € |
|---|---|
|  |   |







| KAWASAKI          |    |    |        |   |        |
|-------------------|----|----|--------|---|--------|
| ER - 6N           | 12 | 16 | TFN215 |  | 95,00  |
| Ninja 400         | 18 | 20 | TFN223 |  | 110,00 |
| Z 650             | 17 | 20 | TFN223 |  | 110,00 |
| Z 750 / Z750 R    | 07 | 12 | TFN215 |  | 95,00  |
| Z 800             | 13 | 16 | TFN215 |  | 95,00  |
| Z 900             | 17 | 20 | TFN223 |  | 110,00 |
| Z 1000 / Z 1000SX | 10 | 16 | TFN215 |  | 95,00  |
| ZX 6 R / ZX636    | 07 | 18 | TFN215 |  | 95,00  |
| ZX636             | 19 | 20 | TFN223 |  | 110,00 |
| ZX 10 R           | 06 | 20 | TFN215 |  | 95,00  |







|        |   |        |
|--------|---|--------|
| TFS215 |  | 120,00 |
| TFS223 |  | 135,00 |
| TFS223 |  | 135,00 |
| TFS215 |  | 120,00 |
| TFS215 |  | 120,00 |
| TFS223 |  | 135,00 |
| TFS215 |  | 120,00 |
| TFS215 |  | 120,00 |
| TFS223 |  | 135,00 |
| TFS215 |  | 120,00 |







| MV AGUSTA |    |    |        |   |       |
|-----------|----|----|--------|---|-------|
| BRUTALE   | 01 | 12 | TFN226 |  | 95,00 |
| F4        | 97 | 09 | TFN226 |  | 95,00 |

|        |   |        |
|--------|---|--------|
| TFS226 |  | 120,00 |
| TFS226 |  | 120,00 |

| SUZUKI         |    |    |        |   |       |
|----------------|----|----|--------|---|-------|
| GSR 600        | 06 | 11 | TFN220 |  | 95,00 |
| GSR 750        | 11 | 16 | TFN220 |  | 95,00 |
| GSXR 600 / 750 | 04 | 17 | TFN220 |  | 95,00 |
| GSXR 1000      | 03 | 16 | TFN220 |  | 95,00 |
| GSXR 1000      | 17 | 20 | TFN220 |  | 95,00 |
| GSXS 750       | 17 | 20 | TFN220 |  | 95,00 |
| GSXS 1000      | 15 | 20 | TFN220 |  | 95,00 |

|        |   |        |
|--------|---|--------|
| TFS220 |  | 120,00 |
| TFS220 |  | 120,00 |
| TFS220 |  | 120,00 |
| TFS220 |  | 120,00 |
| TFS220 |  | 120,00 |
| TFS220 |  | 120,00 |
| TFS220 |  | 120,00 |

| YAMAHA                |    |    |        |   |       |
|-----------------------|----|----|--------|---|-------|
| MT-07                 | 14 | 20 | TFN226 |  | 95,00 |
| MT-09 / MT- 09 Tracer | 13 | 20 | TFN226 |  | 95,00 |
| MT-10                 | 16 | 20 | TFN226 |  | 95,00 |
| R1 / R1M              | 04 | 20 | TFN226 |  | 95,00 |
| R3                    | 15 | 20 | TFN226 |  | 95,00 |
| R6                    | 08 | 20 | TFN226 |  | 95,00 |
| XSR700                | 17 | 20 | TFN226 |  | 95,00 |

|        |   |        |
|--------|---|--------|
| TFS226 |  | 120,00 |
| TFS226 |  | 120,00 |
| TFS226 |  | 120,00 |
| TFS226 |  | 120,00 |
| TFS226 |  | 120,00 |
| TFS226 |  | 120,00 |
| TFS226 |  | 120,00 |





- rosso  
red
- cobalto  
cobalt
- nero  
black
- oro  
gold
- silver  
silver
- verde  
green

**SGANCIO RAPIDO**  
**RAPID LOCKING**

| Modello - Model | Anno - Year | Codice - Code |  |  |   |
|-----------------|-------------|---------------|--|--|---|
|                 |             |               |  |  | € |

| <b>APRILIA</b>          |    |    |        |   |  |               |
|-------------------------|----|----|--------|---|--|---------------|
| RS 660                  | 20 | 21 | TRN214 | <span style="color: red;">■</span> <span style="color: black;">■</span>                                     |  | <b>125,00</b> |
| RSV 1000                | 04 | 08 | TRN210 | <span style="color: red;">■</span> <span style="color: black;">■</span> <span style="color: grey;">■</span> |  | <b>138,00</b> |
| RSV4 (all versions)     | 09 | 20 | TRN210 | <span style="color: red;">■</span> <span style="color: black;">■</span> <span style="color: grey;">■</span> |  | <b>138,00</b> |
| TUONO 660               | 20 | 21 | TRN214 | <span style="color: red;">■</span> <span style="color: black;">■</span>                                     |  | <b>125,00</b> |
| TUONO V4 (all versions) | 11 | 20 | TRN210 | <span style="color: red;">■</span> <span style="color: black;">■</span> <span style="color: grey;">■</span> |  | <b>138,00</b> |

| <b>BMW</b> |    |    |        |   |  |               |
|------------|----|----|--------|---|--|---------------|
| S 1000 R   | 14 | 19 | TRN211 | <span style="color: red;">■</span> <span style="color: black;">■</span> <span style="color: blue;">■</span> |  | <b>138,00</b> |
| S 1000 RR  | 09 | 21 | TRN211 | <span style="color: red;">■</span> <span style="color: black;">■</span> <span style="color: blue;">■</span> |  | <b>138,00</b> |

| <b>DUCATI</b>                         |    |    |        |   |  |               |
|---------------------------------------|----|----|--------|---|--|---------------|
| Monster 821                           | 14 | 17 | TRN226 | <span style="color: red;">■</span> <span style="color: black;">■</span> <span style="color: blue;">■</span> <span style="color: yellow;">■</span> <span style="color: grey;">■</span> |  | <b>125,00</b> |
| Monster 1200 / R                      | 17 | 20 | TRN226 | <span style="color: red;">■</span> <span style="color: black;">■</span> <span style="color: blue;">■</span> <span style="color: yellow;">■</span> <span style="color: grey;">■</span> |  | <b>125,00</b> |
| Panigale 899 / 959 / 1199 / 1299 / V4 | 12 | 20 | TRN212 | <span style="color: red;">■</span> <span style="color: black;">■</span> <span style="color: grey;">■</span>   |  | <b>138,00</b> |
| Streetfighter 848 / 1100              | 09 | 16 | TRN210 | <span style="color: red;">■</span> <span style="color: black;">■</span> <span style="color: grey;">■</span>   |  | <b>138,00</b> |
| Streetfighter V4 / S                  | 20 | 21 | TRN212 | <span style="color: red;">■</span> <span style="color: black;">■</span> <span style="color: grey;">■</span>   |  | <b>138,00</b> |

| <b>HONDA</b>       |    |    |        |   |  |               |
|--------------------|----|----|--------|---|--|---------------|
| CB 125 R           | 18 | 20 | TRN224 | <span style="color: red;">■</span> <span style="color: black;">■</span> |  | <b>125,00</b> |
| CB 300 R           | 18 | 19 | TRN224 | <span style="color: red;">■</span> <span style="color: black;">■</span> |  | <b>125,00</b> |
| CB 500 R           | 16 | 20 | TRN224 | <span style="color: red;">■</span> <span style="color: black;">■</span> |  | <b>125,00</b> |
| CB 650 R           | 18 | 20 | TRN224 | <span style="color: red;">■</span> <span style="color: black;">■</span> |  | <b>125,00</b> |
| CB 650 R           | 21 | 21 | TRN227 | <span style="color: red;">■</span> <span style="color: black;">■</span> |  | <b>125,00</b> |
| CB 1000 R          | 18 | 20 | TRN224 | <span style="color: red;">■</span> <span style="color: black;">■</span> |  | <b>125,00</b> |
| CBR 1000 RR        | 17 | 19 | TRN224 | <span style="color: red;">■</span> <span style="color: black;">■</span> |  | <b>125,00</b> |
| CBR 1000 RR R / SP | 20 | 21 | TRN227 | <span style="color: red;">■</span> <span style="color: black;">■</span> |  | <b>125,00</b> |

■ rosso red  
■ cobalto cobalt  
■ nero black  
■ oro gold  
■ silver silver  
■ verde green

SGANCIO RAPIDO  
RAPID LOCKING

| Modello - Model | Anno - Year |  | Codice - Code   | € |
|-----------------|-------------|--|---|---|
|                 |             |  |  |   |

| KAWASAKI          |    |    |        |  |        |
|-------------------|----|----|--------|--|--------|
| ER - 6N           | 12 | 16 | TRN215 | <span style="color: red;">■</span> <span style="color: black;">■</span> <span style="color: green;">■</span> | 125,00 |
| Ninja 400         | 18 | 20 | TRN223 | <span style="color: red;">■</span> <span style="color: black;">■</span> <span style="color: green;">■</span> | 138,00 |
| Z 650             | 17 | 20 | TRN223 | <span style="color: red;">■</span> <span style="color: black;">■</span> <span style="color: green;">■</span> | 138,00 |
| Z 750 - Z750 R    | 07 | 12 | TRN215 | <span style="color: red;">■</span> <span style="color: black;">■</span> <span style="color: green;">■</span> | 125,00 |
| Z 800             | 13 | 16 | TRN215 | <span style="color: red;">■</span> <span style="color: black;">■</span> <span style="color: green;">■</span> | 125,00 |
| Z 900             | 17 | 20 | TRN223 | <span style="color: red;">■</span> <span style="color: black;">■</span> <span style="color: green;">■</span> | 138,00 |
| Z 1000 / Z 1000SX | 10 | 16 | TRN215 | <span style="color: red;">■</span> <span style="color: black;">■</span> <span style="color: green;">■</span> | 125,00 |
| ZX 6 R / ZX636    | 07 | 18 | TRN215 | <span style="color: red;">■</span> <span style="color: black;">■</span> <span style="color: green;">■</span> | 125,00 |
| ZX636             | 19 | 20 | TRN223 | <span style="color: red;">■</span> <span style="color: black;">■</span> <span style="color: green;">■</span> | 138,00 |
| ZX 10 R           | 06 | 20 | TRN215 | <span style="color: red;">■</span> <span style="color: black;">■</span> <span style="color: green;">■</span> | 125,00 |

| MV AGUSTA |    |    |        |   |        |
|-----------|----|----|--------|---|--------|
| BRUTALE   | 01 | 12 | TRN226 | <span style="color: red;">■</span> <span style="color: black;">■</span> <span style="color: blue;">■</span> <span style="color: yellow;">■</span> <span style="color: silver;">■</span> | 125,00 |
| F4        | 97 | 09 | TRN226 | <span style="color: red;">■</span> <span style="color: black;">■</span> <span style="color: blue;">■</span> <span style="color: yellow;">■</span> <span style="color: silver;">■</span> | 125,00 |

| SUZUKI         |    |    |        |   |        |
|----------------|----|----|--------|---|--------|
| GSR 600        | 06 | 11 | TRN220 | <span style="color: red;">■</span> <span style="color: black;">■</span> <span style="color: blue;">■</span> | 125,00 |
| GSR 750        | 11 | 16 | TRN220 | <span style="color: red;">■</span> <span style="color: black;">■</span> <span style="color: blue;">■</span> | 125,00 |
| GSXR 600 / 750 | 04 | 17 | TRN220 | <span style="color: red;">■</span> <span style="color: black;">■</span> <span style="color: blue;">■</span> | 125,00 |
| GSXR 1000      | 03 | 16 | TRN220 | <span style="color: red;">■</span> <span style="color: black;">■</span> <span style="color: blue;">■</span> | 125,00 |
| GSXR 1000      | 17 | 20 | TRN220 | <span style="color: red;">■</span> <span style="color: black;">■</span> <span style="color: blue;">■</span> | 125,00 |
| GSXS 750       | 17 | 20 | TRN220 | <span style="color: red;">■</span> <span style="color: black;">■</span> <span style="color: blue;">■</span> | 125,00 |
| GSXS 1000      | 15 | 20 | TRN220 | <span style="color: red;">■</span> <span style="color: black;">■</span> <span style="color: blue;">■</span> | 125,00 |

| TRIUMPH                          |    |    |        |   |        |
|----------------------------------|----|----|--------|---|--------|
| Daytona 675 / 675 R              | 11 | 18 | TRN214 | <span style="color: red;">■</span> <span style="color: black;">■</span> | 125,00 |
| Speed Triple 1050                | 11 | 18 | TRN214 | <span style="color: red;">■</span> <span style="color: black;">■</span> | 125,00 |
| Street Triple 675 / 675 R        | 11 | 16 | TRN214 | <span style="color: red;">■</span> <span style="color: black;">■</span> | 125,00 |
| Street Triple 765 S / 765 R / RS | 17 | 20 | TRN214 | <span style="color: red;">■</span> <span style="color: black;">■</span> | 125,00 |

| YAMAHA                |    |    |        |   |        |
|-----------------------|----|----|--------|---|--------|
| MT-07                 | 14 | 20 | TRN226 | <span style="color: red;">■</span> <span style="color: black;">■</span> <span style="color: blue;">■</span> <span style="color: yellow;">■</span> <span style="color: silver;">■</span> | 125,00 |
| MT-09 / MT- 09 Tracer | 13 | 20 | TRN226 | <span style="color: red;">■</span> <span style="color: black;">■</span> <span style="color: blue;">■</span> <span style="color: yellow;">■</span> <span style="color: silver;">■</span> | 125,00 |
| MT-10                 | 16 | 20 | TRN226 | <span style="color: red;">■</span> <span style="color: black;">■</span> <span style="color: blue;">■</span> <span style="color: yellow;">■</span> <span style="color: silver;">■</span> | 125,00 |
| R1 / R1M              | 04 | 20 | TRN226 | <span style="color: red;">■</span> <span style="color: black;">■</span> <span style="color: blue;">■</span> <span style="color: yellow;">■</span> <span style="color: silver;">■</span> | 125,00 |
| R3                    | 15 | 20 | TRN226 | <span style="color: red;">■</span> <span style="color: black;">■</span> <span style="color: blue;">■</span> <span style="color: yellow;">■</span> <span style="color: silver;">■</span> | 125,00 |
| R6                    | 08 | 20 | TRN226 | <span style="color: red;">■</span> <span style="color: black;">■</span> <span style="color: blue;">■</span> <span style="color: yellow;">■</span> <span style="color: silver;">■</span> | 125,00 |
| XSR700                | 17 | 20 | TRN226 | <span style="color: red;">■</span> <span style="color: black;">■</span> <span style="color: blue;">■</span> <span style="color: yellow;">■</span> <span style="color: silver;">■</span> | 125,00 |

# TAPPI SERBATOIO















180 FUEL TANK CAPS

 FINE SERIE - END STOCK

















|   |   |   |   |   |
|---|---|---|---|---|
|  |  |  |  |  |
| rosso<br>red  | cobalto<br>cobalt   | nero<br>black   | oro<br>gold   | silver<br>silver  |

|   |   |
|---|---|
| <b>SGANCIO RAPIDO</b><br><b>RAPID LOCKING</b> | <b>FILETTATO</b><br><b>SPIN LOCKING</b> |
|---|---|

| Modello - Model | Anno - Year | Codice - Code  | € | Codice - Code   | € |
|-----------------|-------------|--|---|---|---|
|                 |             |  |   |  |   |









































| APRILIA                 |    |    |  |        |  |
|-------------------------|----|----|--|--------|--|
| RS 660                  | 20 | 21 | TR14   | 107,00 | TF14   95,00 |
| RSV 1000                | 04 | 08 | TR10   | 124,00 | -  |
| RSV4 R / Factory / APRC | 09 | 20 | TR10   | 124,00 | -  |
| TUONO 660               | 20 | 21 | TR14   | 107,00 | TF14   95,00 |
| TUONO V4                | 11 | 20 | TR10   | 124,00 | -  |

| BMW       |    |    |  |        |   |
|-----------|----|----|--|--------|---|
| S 1000 R  | 14 | 19 | TR11    | 124,00 | - |
| S 1000 RR | 09 | 21 | TR11    | 124,00 | - |

| DUCATI                                    |    |    |  |        |  |
|---|----|----|--|--------|--|
| Diavel                                    | 11 | 17 | -  |        | TF13   95,00 |
| Monster 821                               | 14 | 17 | TR26             | 108,00 | -  |
| Monster 1200 / R                          | 17 | 20 | TR26     | 108,00 | -  |
| Panigale 899 / 959 / 1199 / 1299 / V4 / S | 12 | 20 | TR12     | 124,00 | -  |
| Streetfighter 848 / 1100                  | 09 | 16 | TR10     | 124,00 | -  |
| Streetfighter V4 / S                      | 20 | 21 | TR12     | 124,00 | -  |

| GUZZI                                      |   |   |   |        |   |
|--|---|---|---|--------|---|
| Universal (modello con 6 fori - Ø 99,5 mm) | - | - | TR5     | 107,00 | TF5   84,00 |









| HONDA              |    |    |  |        |  |
|--------------------|----|----|--|--------|--|
| CB 125 R           | 18 | 20 | TR24     | 124,00 | TF24   95,00   |
| CB 300 R           | 18 | 19 | TR24     | 124,00 | TF24   95,00   |
| CB 500 R           | 16 | 20 | TR24     | 124,00 | TF24   95,00   |
| CB 650 R           | 18 | 20 | TR24     | 124,00 | TF24   95,00   |
| CB 650 R           | 21 | 21 | TR27     | 124,00 | -  |
| CB 1000 R          | 18 | 20 | TR24     | 124,00 | TF24   95,00   |
| CBR 600 RR         | 13 | 16 | TR22     | 124,00 | TF22   95,00   |
| CBR 1000 RR        | 04 | 11 | TR22     | 124,00 | TF22   95,00   |
| CBR 1000 RR        | 12 | 14 | TR18      | 124,00 | TF18      95,00 |
| CBR 1000 RR        | 15 | 16 | TR22     | 124,00 | TF22   95,00   |
| CBR 1000 RR        | 17 | 19 | TR24     | 124,00 | TF24   95,00   |
| CBR 1000 RR R / SP | 20 | 21 | TR27     | 124,00 | -  |





















| KAWASAKI          |    |    |  |        |  |
|-------------------|----|----|--|--------|--|
| ER - 6N           | 12 | 16 | TR15      | 107,00 | -  |
| Ninja 300         | 13 | 17 | TR21     | 107,00 | TF21   84,00 |
| Ninja 400         | 18 | 20 | TR23     | 124,00 | -  |
| Z 650             | 17 | 20 | TR23     | 124,00 | -  |
| Z 750 - Z750 R    | 07 | 12 | TR15      | 107,00 | -  |
| Z 800             | 13 | 16 | TR15      | 107,00 | -  |
| Z 900             | 17 | 20 | TR23     | 124,00 | -  |
| Z 1000 / Z 1000SX | 10 | 16 | TR15      | 107,00 | -  |
| ZX 6 R / ZX636    | 07 | 18 | TR15      | 107,00 | -  |
| ZX636             | 19 | 20 | TR23     | 124,00 | -  |
| ZX 10 R           | 06 | 20 | TR15      | 107,00 | -  |













| KTM      |    |    |  |        |  |
|----------|----|----|--|--------|--|
| DUKE 790 | 18 | 20 | TR25  | 107,00 | TF25  95,00 |







FINE SERIE - END STOCK

| Modello - Model | Anno - Year | SGANCIO RAPIDO<br>RAPID LOCKING  |   | FILETTATO<br>SPIN LOCKING   |   |
|-----------------|-------------|--|---|---|---|
|                 |             | Codice - Code  | € | Codice - Code   | € |
|                 |             |  |   |  |   |

| MV AGUSTA          |    |    |  |        |  |   |       |
|--------------------|----|----|--|--------|--|---|-------|
| BRUTALE B3 675/800 | 12 | 17 | TR16  | 112,00 | TF16  |  | 95,00 |
| F3 675 / 800       | 12 | 17 | TR16  | 112,00 | TF16  |  | 95,00 |
| RIVALE             | 14 | 17 | TR16  | 112,00 | TF16  |  | 95,00 |

| SUZUKI         |    |    |  |        |  |   |       |
|----------------|----|----|--|--------|--|---|-------|
| GSR 600        | 06 | 11 | TR20  | 107,00 | TF20  |  | 95,00 |
| GSR 750        | 11 | 16 | TR20  | 107,00 | TF20  |  | 95,00 |
| GSXR 600 / 750 | 04 | 17 | TR20  | 107,00 | TF20  |  | 95,00 |
| GSXR 1000      | 03 | 16 | TR20  | 107,00 | TF20  |  | 95,00 |
| GSXR 1000      | 17 | 20 | TR20  | 107,00 | TF20  |  | 95,00 |
| GSXS 750       | 17 | 20 | TR20  | 107,00 | TF20  |  | 95,00 |
| GSXS 1000      | 15 | 20 | TR20  | 107,00 | TF20  |  | 95,00 |

| TRIUMPH                          |    |    |  |        |  |   |       |
|----------------------------------|----|----|--|--------|--|---|-------|
| Daytona 675 / 675 R / 765        | 11 | 20 | TR14  | 107,00 | TF14  |  | 95,00 |
| Speed Triple 1050                | 11 | 18 | TR14  | 107,00 | TF14  |  | 95,00 |
| Street Triple 675 / 675 R        | 11 | 16 | TR14  | 107,00 | TF14  |  | 95,00 |
| Street Triple 765 S / 765 R / RS | 17 | 20 | TR14  | 107,00 | TF14  |  | 95,00 |

| YAMAHA                |    |    |  |        |   |  |  |
|-----------------------|----|----|--|--------|---|--|--|
| MT-07                 | 14 | 20 | TR26  | 108,00 | - |  |  |
| MT-09 / MT- 09 Tracer | 13 | 20 | TR26  | 108,00 | - |  |  |
| MT-10                 | 16 | 20 | TR26  | 108,00 | - |  |  |
| R1 / R1M              | 04 | 20 | TR26  | 108,00 | - |  |  |
| R3                    | 15 | 20 | TR26  | 108,00 | - |  |  |
| R6                    | 08 | 20 | TR26  | 108,00 | - |  |  |
| XSR700                | 17 | 20 | TR26  | 108,00 | - |  |  |



# TAPPI SERBATOIO

182 FUEL TANK CAPS

NEW!



Model FCF

Ricambio Flangia interna - Internal spare part

FCF € 28,00

Colori disponibili - Available colours:



a pezzo - for piece



Model TRF

Ricambio Flangia interna - Internal spare part

TRF € 54,00

Colori disponibili: nero  
Available colours: black

a pezzo - for piece



Model TFC

Ricambio Flangia interna - Internal spare part

TFC € 26,00

Colori disponibili: nero  
Available colours: black

a pezzo - for piece



Chiave racing universale per tappo serbatoio e tappo olio  
Universal racing key for fuel tank cap and oil filler cap

TFT € 28,00

a pezzo - for piece







cm<sup>3</sup> 16

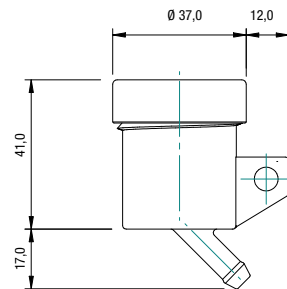

Bocchetta olio trasparente fumè con tappo in alluminio / Fluid reservoir fumè with aluminium cap.

OBT004 € 38,00

a pezzo - for piece

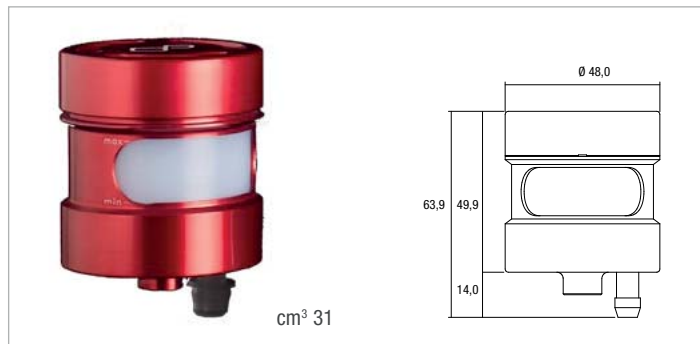

cm<sup>3</sup> 31

Bocchetta olio con involucro in alluminio / Fluid reservoir with aluminium case

OBT001 € 46,80

a pezzo - for piece



cm<sup>3</sup> 16

Bocchetta olio con involucro in alluminio / Fluid reservoir with aluminium case

OBT002 € 57,20

a pezzo - for piece



assembled on: OBT001

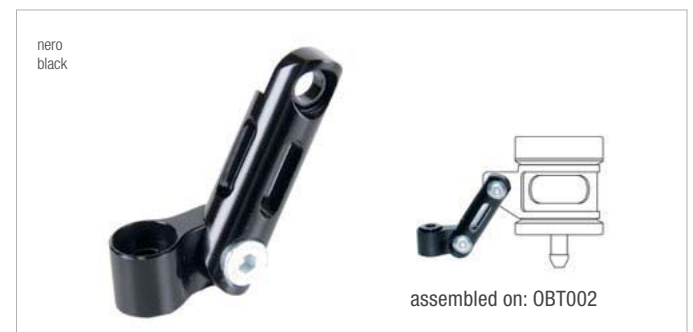

assembled on: OBT002

Supporto per OBT001 / OBT002 - Holder for OBT001 / OBT002

OBT003 € 32,20

a pezzo - for piece



| Modello - Model                             | Anno - Year |    | filetto - thread | Codice - Code | €     | Codice - Code | €     |
|---|-------------|----|------------------|---------------|-------|---------------|-------|
| <b>APRILIA</b>                              |             |    |                  |               |       |               |       |
| RS 660 / TUONO 660                          | 20          | 21 | M 20 X 1,5       | OIL 001       | 21,10 | OILS          | 21,10 |
| DORSODURO 750                               | 08          | 13 | M 25 X 1,5       | OIL 002       | 21,10 | OILA          | 21,10 |
| DORSODURO 750                               | 14          | 16 | M 20 X 1,5       | OIL 001       | 21,10 | OILS          | 20,00 |
| DORSODURO 900                               | 18          | 21 | M 20 X 1,5       | OIL 001       | 21,10 | OILS          | 20,00 |
| DORSODURO 1200                              | 11          | 16 | M 20 X 1,5       | OIL 001       | 21,10 | OILS          | 20,00 |
| RSV 4 / Factory APRC / 1100 Factory         | 09          | 20 | M 25 X 1,5       | OIL 002       | 21,10 | OILA          | 21,10 |
| SHIVER 750                                  | 07          | 15 | M 25 X 1,5       | OIL 002       | 21,10 | OILA          | 20,00 |
| TUONO                                       | 06          | 09 | M 20 X 1,5       | OIL 001       | 21,10 | OILS          | 20,00 |
| TUONO V4                                    | 11          | 20 | M 25 X 1,5       | OIL 002       | 21,10 | OILA          | 21,10 |
| <b>BMW</b>                                  |             |    |                  |               |       |               |       |
| R Nine-T / Scrambler / Pure / Urban / Racer | 16          | 19 | M 34 x 1,5       | OIL 008       | 23,40 |               |       |
| R 1200 GS                                   | 08          | 12 | M 34 x 1,5       | OIL 008       | 23,40 |               |       |
| S1000 R                                     | 14          | 19 | M 24 X 2         | OIL 007       | 21,10 | OILBM01       | 21,10 |
| S1000 RR                                    | 09          | 20 | M 24 X 2         | OIL 007       | 21,10 | OILBM01       | 21,10 |
| <b>DUCATI</b>                               |             |    |                  |               |       |               |       |
| 848   | 08          | 10 | M 20 X 2,5       | OIL 011       | 21,10 |               |       |
| 1098 - 1198                                 | 07          | 11 | M 22 X 1,5       | OIL 003       | 20,00 | OILD          | 20,00 |
| HYPERMOTARD 796                             | 09          | 12 | M 20 X 2,5       | OIL 011       | 21,10 |               |       |
| HYPERMOTARD 821 / HYPERSTRADA 821           | 13          | 15 | M 20 X 2,5       | OIL 011       | 21,10 |               |       |
| HYPERMOTARD 939                             | 16          | 18 | M 20 X 2,5       | OIL 011       | 21,10 |               |       |
| HYPERMOTARD 950                             | 19          | 20 | M 20 X 2,5       | OIL 011       | 21,10 |               |       |
| MONSTER 696                                 | 08          | 15 | M 19,5 X 2,5     | OIL 004       | 20,00 | OILH          | 20,00 |
| MONSTER 821                                 | 14          | 19 | M 20 X 2,5       | OIL 011       | 21,10 |               |       |
| MONSTER 1100                                | 11          | 13 | M 20 X 2,5       | OIL 011       | 21,10 |               |       |
| MONSTER 1200 / 1200S                        | 14          | 20 | M 20 X 2,5       | OIL 011       | 21,10 |               |       |
| MULTISTRADA 1200                            | 10          | 13 | M 19,5 X 2,5     | OIL 004       | 20,00 | OILH          | 20,00 |
| PANIGALE 1199 / 899                         | 12          | 15 | M 19,5 X 2,5     | OIL 004       | 20,00 | OILH          | 20,00 |
| PANIGALE 1299 / V4                          | 15          | 20 | M 20 X 2,5       | OIL 011       | 21,10 |               |       |
| STREETFIGHTER 848                           | 11          | 16 | M 20 X 2,5       | OIL 011       | 21,10 |               |       |
| STREETFIGHTER 1100                          | 09          | 15 | M 22 X 1,5       | OIL 003       | 20,00 | OILD          | 20,00 |
| STREETFIGHTER V4 / S                        | 20          | 21 | M 20 X 2,5       | OIL 011       | 21,10 |               |       |
| <b>GUZZI</b>                                |             |    |                  |               |       |               |       |
| GRISO 850 / 1100 / 1150                     | 06          | 15 | M 20 X 1,5       | OIL 001       | 21,10 | OILS          | 20,00 |
| <b>HONDA</b>                                |             |    |                  |               |       |               |       |
| tutte / all                                 | -           | -  | M 19,5 X 2,5     | OIL 004       | 20,00 | OILH          | 20,00 |
| CB 500 R                                    | 16          | 20 | M 19,5 X 2,5     | OIL 004       | 20,00 | OILH          | 20,00 |
| CB 650 R                                    | 19          | 21 | M 20 X 2,5       | OIL 011       | 21,10 |               |       |
| CBR 1000 RR-R / SP                          | 20          | 21 | M 20 X 2,5       | OIL 011       | 21,10 |               |       |
| XADV  | 17          | 20 | M 20 X 2,5       | OIL 011       | 21,10 |               |       |





| Modello - Model                   | Anno - Year |    | filetto - thread | Codice - Code | €     | Codice - Code | €     |
|-----------------------------------|-------------|----|------------------|---------------|-------|---------------|-------|
| <b>KAWASAKI</b>                   |             |    |                  |               |       |               |       |
| * ER 6N                           | 06          | 15 | M 19,5 X 2,5     | OIL 004       | 20,00 | OILH          | 20,00 |
| * Ninja 400                       | 18          | 20 | M 20 X 2,5       | OIL 011       | 21,10 |               |       |
| * Z125                            | 19          | 20 | M 20 X 2,5       | OIL 011       | 21,10 |               |       |
| * Z400                            | 17          | 20 | M 20 X 2,5       | OIL 011       | 21,10 |               |       |
| * Z 650                           | 17          | 21 | M 20 X 2,5       | OIL 011       | 21,10 |               |       |
| * Z 800                           | 13          | 16 | M 20 X 2,5       | OIL 011       | 21,10 |               |       |
| * Z 900                           | 17          | 21 | M 20 X 2,5       | OIL 011       | 21,10 |               |       |
| * Z 1000                          | 03          | 09 | M 30 X 1,5       | OIL 005       | 23,40 | OILK2         | 21,30 |
| * Z 1000                          | 10          | 19 | M 20 X 2,5       | OIL 011       | 21,10 |               |       |
| * Z 1000 SX                       | 11          | 19 | M 20 X 2,5       | OIL 011       | 21,10 |               |       |
| * ZX6R / 636                      | 05          | 21 | M 30 X 1,5       | OIL 005       | 23,40 | OILK2         | 21,30 |
| * ZX10R                           | 04          | 20 | M 30 X 1,5       | OIL 005       | 23,40 | OILK2         | 21,30 |
| <b>KTM</b>                        |             |    |                  |               |       |               |       |
| DUKE 790                          | 18          | 21 | M 24 X 3         | OIL 013       | 20,00 |               |       |
| DUKE 890 R                        | 20          | 21 | M 24 X 3         | OIL 013       | 20,00 |               |       |
| DUKE 1290 R                       | 20          | 21 | M 24 X 3         | OIL 013       | 20,00 |               |       |
| <b>MV AGUSTA</b>                  |             |    |                  |               |       |               |       |
| BRUTALE 750 / 910 / 990 / 1090    | 00          | 17 | M 25 X 1,5       | OIL 002       | 21,10 |               |       |
| B3 675 / 800                      | 12          | 17 | M 24 X 3         | OIL 013       | 20,00 |               |       |
| F3 675 / 800                      | 12          | 17 | M 24 X 3         | OIL 013       | 20,00 |               |       |
| F4 750 / 910 / 990 / 1090         | 00          | 17 | M 25 X 1,5       | OIL 002       | 21,10 |               |       |
| RIVALE 800                        | 13          | 17 | M 24 X 3         | OIL 013       | 20,00 |               |       |
| <b>SUZUKI</b>                     |             |    |                  |               |       |               |       |
| GSXR 600 / 750                    | 06          | 10 | M 20 X 1,5       | OIL 001       | 21,10 | OILS          | 20,00 |
| GSXR 600 / 750                    | 11          | 17 | M 20 X 1,5       | OIL 001       | 21,10 | OILS          | 20,00 |
| GSXR 1000                         | 07          | 11 | M 20 X 1,5       | OIL 001       | 21,10 | OILS          | 20,00 |
| GSXR 1000                         | 12          | 16 | M 20 X 1,5       | OIL 001       | 21,10 | OILS          | 20,00 |
| GSXR 1000                         | 17          | 21 | M 20 X 1,5       | OIL 001       | 21,10 | OILS          | 20,00 |
| GSX-S 750                         | 17          | 21 | M 20 X 1,5       | OIL 001       | 21,10 | OILS          | 20,00 |
| GSX-S 1000                        | 15          | 21 | M 20 X 1,5       | OIL 001       | 21,10 | OILS          | 20,00 |
| <b>TRIUMPH</b>                    |             |    |                  |               |       |               |       |
| tutte / all                       | -           | -  | M 19,5 X 2,5     | OIL 004       | 20,00 | OILH          | 20,0  |
| Street Triple 765S / 765R / 765RS | 17          | 21 | M 20 X 2,5       | OIL 011       | 21,10 |               |       |
| <b>YAMAHA</b>                     |             |    |                  |               |       |               |       |
| MT 03 (660CC) monocilindrico      | 06          | 14 | M 19,5 X 2,5     | OIL 004       | 20,00 | OILH          | 20,00 |
| MT03 (321CC) bicilindrico         | 16          | 21 | M 26 X 3         | OIL 006       | 21,10 | OILY          | 21,10 |
| MT-07 / XMT-07                    | 14          | 21 | M 26 X 3         | OIL 006       | 21,10 | OILY          | 21,10 |
| MT-09 / MT - 09 Tracer            | 13          | 21 | M 20 X 2,5       | OIL 011       | 21,10 |               |       |
| MT-10                             | 16          | 21 | M 26 X 3         | OIL 006       | 21,10 | OILY          | 21,10 |
| R1 / R1M                          | 15          | 21 | M 26 X 3         | OIL 006       | 21,10 | OILY          | 21,10 |
| R3                                | 15          | 21 | M 26 X 3         | OIL 006       | 21,10 | OILY          | 21,10 |
| R6                                | 06          | 20 | M 26 X 3         | OIL 006       | 21,10 | OILY          | 21,10 |
| T-MAX 500 / 530 / 560             | 08          | 21 | M 19,5 X 2,5     | OIL 004       | 20,00 | OILH          | 20,00 |



NEW

■\*  
Only: OIL004 / OIL005 / OIL011

■\*  
Only: OIL013



| Modello - Model                             | Anno - Year |         | Articolo - Article      | Codice - Code | €     |       |
|---|-------------|---------|-------------------------|---------------|-------|-------|
|   | dal - from  | al - to |                         |               |       |       |
| <b>APRILIA</b>                              |             |         |                         |               |       |       |
| Dorsoduro 750                               | 09          | 16      | freno ant / front brake | ■ ■           | FBC17 | 29,00 |
|   |             |         | freno post / rear brake | ■ ■ ■ ■ ■     | FFC05 | 21,30 |
|   |             |         | frizione / clutch       | ■ ■           | FFC06 | 29,00 |
| Dorsoduro 900                               | 18          | 20      | freno ant / front brake | ■ ■           | FBC17 | 29,00 |
|   |             |         | freno post / rear brake | ■ ■ ■ ■ ■     | FFC05 | 21,30 |
|   |             |         | frizione / clutch       | ■ ■           | FFC06 | 29,00 |
| RSV 4 / Factory / APRC                      | 09          | 20      | freno ant / front brake | ■ ■ ■ ■ ■ ■ ■ | FBC04 | 22,30 |
| Shiver 750                                  | 07          | 16      | freno post / rear brake | ■ ■ ■ ■ ■     | FFC05 | 21,30 |
| Tuono V4                                    | 11          | 20      | freno ant / front brake | ■ ■ ■ ■ ■ ■ ■ | FBC04 | 22,30 |
| <b>BMW</b>                                  |             |         |                         |               |       |       |
| R Nine-T / Scrambler / Pure / Urban / Racer | 16          | 19      | freno ant / front brake | ■ ■           | FBC25 | 46,80 |
|   |             |         | frizione / clutch       | ■ ■           | FFC11 | 46,80 |
| S 1000 R                                    | 14          | 19      | freno ant / front brake | ■ ■ ■ ■ ■ ■ ■ | FBC06 | 22,30 |
| S 1000 RR                                   | 09          | 20      | freno ant / front brake | ■ ■ ■ ■ ■ ■ ■ | FBC06 | 22,30 |
| <b>DUCATI</b>                               |             |         |                         |               |       |       |
| 848 / 1098 / 1198                           | 07          | 11      | freno ant / front brake | ■ ■ ■ ■ ■ ■ ■ | FBC04 | 22,30 |
|   |             |         | freno post / rear brake | ■ ■           | FFC03 | 19,20 |
|   |             |         | frizione / clutch       | ■ ■           | FFC03 | 19,20 |
| Hypermotard 821 / 939                       | 12          | 17      | freno ant / front brake | ■ ■           | FBC07 | 29,00 |
|   |             |         | freno post / rear brake | ■ ■           | FFC03 | 19,20 |
| Hypermotard 950 / SP                        | 19          | 20      | freno ant / front brake | ■ ■ ■ ■ ■ ■ ■ | FBC04 | 22,30 |
|   |             |         | freno post / rear brake | ■ ■           | FFC03 | 19,20 |
|   |             |         | frizione / clutch       | ■ ■ ■ ■ ■ ■ ■ | FBC27 | 19,20 |
| Hypermotard 1100                            | 07          | 10      | freno ant / front brake | ■ ■ ■ ■ ■ ■ ■ | FBC04 | 22,30 |
|   |             |         | freno post / rear brake | ■ ■           | FFC03 | 19,20 |
|   |             |         | frizione / clutch       | ■ ■           | FFC03 | 19,20 |
| Monster 696 / 796                           | 08          | 15      | freno ant / front brake | ■ ■           | FBC07 | 29,00 |
|   |             |         | freno post / rear brake | ■ ■           | FFC03 | 19,20 |
|   |             |         | frizione / clutch       | ■ ■           | FFC04 | 27,00 |
| Monster 821                                 | 14          | 17      | freno ant / front brake | ■ ■           | FBC07 | 29,00 |
|   |             |         | freno post / rear brake | ■ ■           | FFC03 | 19,20 |
| Monster 1100                                | 11          | 13      | freno post / rear brake | ■ ■           | FFC03 | 19,20 |
| Monster 1200 / 1200S                        | 14          | 20      | freno ant / front brake | ■ ■ ■ ■ ■ ■ ■ | FBC04 | 22,30 |
|   |             |         | freno post / rear brake | ■ ■           | FFC03 | 19,20 |
|   |             |         | frizione / clutch       | ■ ■ ■ ■ ■ ■ ■ | FBC27 | 19,20 |
| Multistrada 1200                            | 10          | 12      | freno ant / front brake | ■ ■ ■ ■ ■ ■ ■ | FBC04 | 22,30 |
|   |             |         | freno post / rear brake | ■ ■           | FFC03 | 19,20 |
|   |             |         | frizione / clutch       | ■ ■           | FFC03 | 19,20 |
| Panigale 1199 / 1299                        | 12          | 17      | freno ant / front brake | ■ ■ ■ ■ ■ ■ ■ | FBC04 | 22,30 |
|   |             |         | freno post / rear brake | ■ ■           | FFC03 | 19,20 |
|   |             |         | frizione / clutch       | ■ ■           | FFC03 | 19,20 |
| Panigale V4                                 | 18          | 20      | freno ant / front brake | ■ ■ ■ ■ ■ ■ ■ | FBC04 | 22,30 |
|   |             |         | freno post / rear brake | ■ ■           | FFC03 | 19,20 |
|   |             |         | frizione / clutch       | ■ ■ ■ ■ ■ ■ ■ | FBC27 | 19,20 |
| Streetfighter 848 / 1100                    | 09          | 16      | freno ant / front brake | ■ ■           | FBC18 | 29,00 |
|   |             |         | freno post / rear brake | ■ ■           | FFC03 | 19,20 |
|   |             |         | frizione / clutch       | ■ ■           | FFC07 | 29,00 |



FBC21



FFC06



FBC19



FBC18

| Modello - Model  | Anno - Year |         | Articolo - Article          | Codice - Code   | €            |
|------------------|-------------|---------|-----------------------------|-----------------|--------------|
|                  | dal - from  | al - to |                             |                 |              |
| <b>HONDA</b>     |             |         |                             |                 |              |
| CB 125 R         | 18          | 20      | freno post / rear brake     | ■ ■ ■           | FBC28 22,30  |
| CB 650F          | 14          | 15      | freno ant / front brake     | ■ ■             | FBC01 31,20  |
| CB 650R          | 19          | 21      | freno ant / front brake     | ■ ■             | FBC01 31,20  |
| CB 1000 R        | 08          | 17      | freno ant / front brake     | ■ ■ ■ ■ ■ ■ ■ ■ | FBC06 22,30  |
|                  |             |         | freno post / rear brake     | ■ ■ ■ ■ ■ ■ ■ ■ | FBC06 22,30  |
|                  |             |         | frizione / clutch           | ■ ■ ■ ■ ■       | FFC05 21,30  |
| CB 1000 R        | 18          | 20      | freno ant / front brake     | ■ ■ ■           | FBC29 35,00  |
|                  |             |         | freno post / rear brake     | ■ ■ ■           | FBC28 22,30  |
| CBR 500 R        | 16          | 20      | freno post / rear brake     | ■ ■ ■           | FBC28 22,30  |
| CBR 600 RR       | 03          | 06      | freno ant / front brake     | ■ ■             | FBC01 31,20  |
| CBR 600 RR       | 07          | 16      | freno ant / front brake     | ■ ■ ■ ■ ■ ■ ■ ■ | FBC06 22,30  |
| CBR 1000 RR      | 08          | 17      | freno ant / front brake     | ■ ■ ■ ■ ■ ■ ■ ■ | FBC06 22,30  |
|                  |             |         | freno post / rear brake     | ■ ■ ■ ■ ■ ■     | FFC05 21,30  |
| CBR 1000 RR-R    | 20          | 20      | freno ant / front brake     | ■ ■ ■ ■ ■ ■ ■ ■ | FBC06 22,30  |
| CBR 1000 RR-R SP | 20          | 20      | freno ant / front brake     | ■ ■ ■ ■ ■ ■ ■ ■ | FBC04 22,30  |
| Hornet 600       | 11          | 13      | freno ant / front brake     | ■ ■             | FBC01 31,20  |
| X ADV            | 17          | 20      | freno destro / right brake  | ■ ■             | FBC01 31,20  |
|                  |             |         | freno sinistro / left brake | ■ ■             | FBC01 31,20  |
| <b>HUSQVARNA</b> |             |         |                             |                 |              |
| 900 NUDA         | 12          | 15      | freno ant / front brake     | ■ ■ ■ ■ ■ ■ ■ ■ | FBC04* 22,30 |

\* necessita di due viti 005-M5x45 / two bolts 005-M5x45 required





| Modello - Model   | Anno - Year |         | Articolo - Article      | Codice - Code | €           |
|-------------------|-------------|---------|-------------------------|---------------|-------------|
|                   | dal - from  | al - to |                         |               |             |
| <b>KAWASAKI</b>   |             |         |                         |               |             |
| ER - 6N           | 06          | 08      | freno ant / front brake |               | FBC02 29,00 |
| ER - 6N           | 09          | 15      | freno ant / front brake |               | FBC16 22,30 |
| Ninja 250R        | 09          | 12      | freno post / rear brake |               | FBC06 22,30 |
| Ninja 250 / 400   | 18          | 20      | freno ant / front brake |               | FBC26 29,00 |
|                   |             |         | freno post / rear brake |               | FFC05 21,30 |
| Z650              | 17          | 20      | freno ant / front brake |               | FBC16 22,30 |
| Z750 / Z1000      | 03          | 06      | freno ant / front brake |               | FBC02 29,00 |
| Z750              | 07          | 12      | freno ant / front brake |               | FBC06 22,30 |
| Z750 R            | 11          | 12      | freno ant / front brake |               | FBC19 29,00 |
| Z800              | 13          | 16      | freno ant / front brake |               | FBC16 22,30 |
|                   |             |         | freno post / rear brake |               | FFC05 21,30 |
| Z900              | 17          | 20      | freno ant / front brake |               | FBC16 22,30 |
| Z1000             | 07          | 09      | freno ant / front brake |               | FBC06 22,30 |
|                   | 10          | 18      | freno ant / front brake |               | FBC19 29,00 |
| Z1000SX           | 11          | 18      | freno ant / front brake |               | FBC06 22,30 |
|                   |             |         | freno post / rear brake |               | FFC05 21,30 |
| ZX6R              | 07          | 08      | freno ant / front brake |               | FBC06 22,30 |
|                   |             |         | freno post / rear brake |               | FFC05 21,30 |
| ZX6R              | 09          | 15      | freno ant / front brake |               | FBC06 22,30 |
|                   |             |         | freno post / rear brake |               | FBC23 21,30 |
| ZX6R / 636        | 16          | 20      | freno ant / front brake |               | FBC06 22,30 |
|                   |             |         | freno post / rear brake |               | FFC05 21,30 |
| ZX10R             | 08          | 15      | freno ant / front brake |               | FBC06 22,30 |
|                   |             |         | freno post / rear brake |               | FFC05 21,30 |
| ZX10R             | 16          | 20      | freno ant / front brake |               | FBC04 22,30 |
|                   |             |         | freno post / rear brake |               | FFC05 21,30 |
| <b>KTM</b>        |             |         |                         |               |             |
| Duke 790          | 18          | 20      | freno ant / front brake |               | FBC30 38,50 |
| RC8 1190          | 08          | 12      | freno ant / front brake |               | FBC06 22,30 |
| 990 Super Duke    | 07          | 12      | freno ant / front brake |               | FBC04 22,30 |
|                   |             |         | freno post / rear brake |               | FFC03 19,20 |
| 690 SM / SMR      | 07          | 12      | freno ant / front brake |               | FFC04 27,00 |
|                   |             |         | freno post / rear brake |               | FFC03 22,30 |
| 1290 Super Duke R | 20          | 20      | freno ant / front brake |               | FBC04 22,30 |
|                   |             |         | frizione / clutch       |               | FBC31 21,30 |
| <b>MV AGUSTA</b>  |             |         |                         |               |             |
| B3 675 / 800      | 12          | 17      | freno ant / front brake |               | FBC03 31,20 |
| Dragster          | 15          | 17      | freno ant / front brake |               | FBC03 31,20 |
| F3 675 / 800      | 12          | 17      | freno ant / front brake |               | FBC06 22,30 |
| Brutale           | 05          | 17      | freno ant / front brake |               | FBC03 31,20 |
|                   |             |         | frizione / clutch       |               | FFC01 31,20 |
| F4                | 00          | 09      | freno ant / front brake |               | FBC03 31,20 |
|                   |             |         | frizione / clutch       |               | FFC01 31,20 |
| F4                | 14          | 17      | freno ant / front brake |               | FBC04 22,30 |
|                   |             |         | frizione / clutch       |               | FFC03 19,20 |
| Rivale 800        | 14          | 17      | freno ant / front brake |               | FBC03 31,20 |



FBC17



FBC06



FFC03



FBC07



FBC27

| Modello - Model                   | Anno - Year |         | Articolo - Article      | Codice - Code | €           |
|-----------------------------------|-------------|---------|-------------------------|---------------|-------------|
|                                   | dal - from  | al - to |                         |               |             |
| <b>SUZUKI</b>                     |             |         |                         |               |             |
| Gladius 650                       | 09          | 15      | freno ant / front brake |               | FBC13 29,00 |
| GSR 600                           | 06          | 12      | freno ant / front brake |               | FBC13 29,00 |
| GSR 750                           | 11          | 16      | freno ant / front brake |               | FBC13 29,00 |
| GSXR 600 / 750                    | 04          | 10      | freno ant / front brake |               | FBC06 22,30 |
| GSXR 1000                         | 05          | 06      | freno ant / front brake |               | FBC06 22,30 |
| GSXR 1000                         | 07          | 08      | freno ant / front brake |               | FBC06 22,30 |
|                                   |             |         | frizione / clutch       |               | FFC05 21,30 |
| GSXR 1000                         | 09          | 20      | freno ant / front brake |               | FBC06 22,30 |
| GSX-S 750                         | 17          | 20      | freno ant / front brake |               | FBC13 29,00 |
| GSX-S 1000                        | 15          | 20      | freno ant / front brake |               | FBC24 22,30 |
| <b>TRIUMPH</b>                    |             |         |                         |               |             |
| Daytona 675 / 675 R               | 07          | 16      | freno ant / front brake |               | FBC06 22,30 |
|                                   |             |         | freno post / rear brake |               | FFC05 21,30 |
| Street Triple 675 / 675 R         | 07          | 16      | freno post / rear brake |               | FFC05 21,30 |
| Street Triple 765S / 765R / 765RS | 17          | 20      | freno ant / front brake |               | FBC04 22,30 |
|                                   |             |         | freno post / rear brake |               | FFC05 21,30 |
| Speed Triple 1050                 | 12          | 18      | freno ant / front brake |               | FBC04 22,30 |
|                                   |             |         | freno post / rear brake |               | FFC05 21,30 |
| <b>YAMAHA</b>                     |             |         |                         |               |             |
| Fazer 1000                        | 01          | 05      | freno ant / front brake |               | FBC02 29,00 |
| FZ1                               | 06          | 15      | freno ant / front brake |               | FBC11 31,20 |
| FZ8                               | 10          | 15      | freno ant / front brake |               | FBC11 31,20 |
| FZ6                               | 04          | 06      | freno ant / front brake |               | FBC11 31,20 |
| MT-03                             | 06          | 13      | freno ant / front brake |               | FBC11 31,20 |
|                                   |             |         | freno post / rear brake |               | FFC05 21,30 |
| MT-07 / Tracer                    | 14          | 20      | freno ant / front brake |               | FBC02 29,00 |
|                                   |             |         | freno post / rear brake |               | FFC05 21,30 |
| MT-09 / Tracer                    | 13          | 20      | freno ant / front brake |               | FBC11 31,20 |
|                                   |             |         | freno post / rear brake |               | FFC05 21,30 |
| R6                                | 03          | 05      | freno ant / front brake |               | FBC06 22,30 |
| R6                                | 06          | 20      | freno ant / front brake |               | FBC06 22,30 |
|                                   |             |         | freno post / rear brake |               | FFC05 21,30 |
| R1                                | 04          | 20      | freno ant / front brake |               | FBC06 22,30 |
| R1 / R1M                          | 15          | 20      | freno post / rear brake |               | FBC23 21,30 |
| T - MAX 500 / 530 / 560           | 04          | 20      | freno ant / front brake |               | FBC15 29,00 |
|                                   |             |         | freno post / rear brake |               | FBC15 29,00 |
| XJ6                               | 08          | 15      | freno ant / front brake |               | FBC11 31,20 |



FBC01



FBC02



FBC04



FBC11



FBC18



FBC25



FBC26



FBC29





**CARBONIO**  
**CARBON**



# COMPONENTI IN CARBONIO

192 CARBON PARTS

NEW

| Modello - Model   | Anno - Year |         | Codice - Code | € | Codice - Code |  | € |
|---|-------------|---------|---------------|---|---------------|--|---|
|   | dal - from  | al - to | LUCIDO-SHINE  |   | OPACO-MATT    |  |   |
| <b>RS660 / TUONO 660</b>                                |             |         |               |   |               |  |   |
| parafango ant. / front mudguard                         | 20          | 21      | CARA0610      |   |               |  |   |
| parafango post. / rear mudguard                         | 20          | 21      | CARA0620      |   |               |  |   |
| copri serbatoio / tank cover                            | 20          | 21      | CARA0629      |   |               |  |   |
| coperchio frizione / clutch cover                       | 20          | 21      | CARA0630      |   |               |  |   |
| coperchio alternatore / electric cover                  | 20          | 21      | CARA0640      |   |               |  |   |
| protezioni telaio / frame protector                     | 20          | 21      | CARA0650      |   |               |  |   |
| protezioni forcellone / swingarm protector              | 20          | 21      | CARA0660      |   |               |  |   |
| fianchetti laterali sotto serbatoio / under tank panels | 20          | 21      | CARA0680      |   |               |  |   |
| cover sellino passeggero / passenger seat cover         | 20          | 21      | CARA0690      |   |               |  |   |

APRILIA

|   |    |    |          |               |  |  |  |
|---|----|----|----------|---------------|--|--|--|
| <b>RSV4 (all models)</b>                                |    |    |          |               |  |  |  |
| parafango ant. / front mudguard                         | 09 | 20 | CARA3010 | <b>180,00</b> |  |  |  |
| parafango post. / rear mudguard                         | 09 | 20 | CARA3020 | <b>129,60</b> |  |  |  |
| coperchio frizione / clutch cover                       | 09 | 20 | CARA3030 | <b>129,60</b> |  |  |  |
| coperchio alternatore / electric cover                  | 09 | 20 | CARA3040 | <b>103,20</b> |  |  |  |
| protezioni telaio / frame protector                     | 09 | 14 | CARA3050 | <b>216,00</b> |  |  |  |
| protezioni telaio / frame protector                     | 15 | 20 | CARA4050 | <b>216,00</b> |  |  |  |
| protezioni forcellone / swingarm protector              | 09 | 14 | CARA3060 | <b>180,00</b> |  |  |  |
| protezioni forcellone / swingarm protector              | 15 | 20 | CARA4060 | <b>180,00</b> |  |  |  |
| tubi airbox / racing airducts                           | 09 | 19 | CARA3019 | <b>288,00</b> |  |  |  |
| copri catena / chain cover                              | 09 | 20 | CARA3012 | <b>84,00</b>  |  |  |  |
| para catena inferiore / inferior chain protection       | 09 | 20 | CARA3013 | <b>76,80</b>  |  |  |  |
| fianchetti laterali sotto serbatoio / under tank panels | 09 | 20 | CARA3080 | <b>288,00</b> |  |  |  |

|   |    |    |          |               |  |  |  |
|---|----|----|----------|---------------|--|--|--|
| <b>TUONO V4</b>                                   |    |    |          |               |  |  |  |
| parafango ant. / front mudguard                   | 11 | 20 | CARA3010 | <b>180,00</b> |  |  |  |
| parafango post. / rear mudguard                   | 11 | 20 | CARA3020 | <b>129,60</b> |  |  |  |
| coperchio frizione / clutch cover                 | 11 | 20 | CARA3030 | <b>129,60</b> |  |  |  |
| coperchio alternatore / electric cover            | 11 | 20 | CARA3040 | <b>103,20</b> |  |  |  |
| protezioni forcellone / swingarm protector        | 11 | 20 | CARA3060 | <b>180,00</b> |  |  |  |
| copri catena / chain cover                        | 11 | 20 | CARA3012 | <b>84,00</b>  |  |  |  |
| para catena inferiore / inferior chain protection | 11 | 20 | CARA3013 | <b>76,80</b>  |  |  |  |



| Modello - Model   | Anno - Year |         | Codice - Code | €             | Codice - Code | €             |
|---|-------------|---------|---------------|---------------|---------------|---------------|
|   | dal - from  | al - to | LUCIDO-SHINE  |               | OPACO-MATT    |               |
| <b>R-nine T Scrambler</b>   |             |         |               |               |               |               |
| parafango ant. con fissaggio laterale / front mudguard (side fitment)   | 16          | 19      | CARB2010      | <b>228,00</b> | CARB2010M     | <b>228,00</b> |
| parafango ant. con fissaggio superiore / front mudguard (upper fitment) | 17          | 19      | CARB2210      | <b>228,00</b> | CARB2210M     | <b>228,00</b> |
| protezioni teste motore / engine covers                                 | 16          | 19      | CARB2000      | <b>240,00</b> | CARB2000M     | <b>240,00</b> |

|   |    |    |          |               |  |  |
|---|----|----|----------|---------------|--|--|
| <b>S 1000 R</b>   |    |    |          |               |  |  |
| parafango ant. / front mudguard                                       | 13 | 19 | CARB1010 | <b>180,00</b> |  |  |
| parafango post. con copri catena / rear mudguard with chain protector | 13 | 19 | CARB1020 | <b>163,20</b> |  |  |
| coperchio frizione / clutch cover                                     | 13 | 14 | CARB1030 | <b>129,60</b> |  |  |
| coperchio frizione / clutch cover                                     | 15 | 18 | CARB1031 | <b>129,60</b> |  |  |
| coperchio alternatore / electric cover                                | 13 | 19 | CARB1040 | <b>108,00</b> |  |  |
| coperchio pick up / pick up cover                                     | 13 | 16 | CARB1018 | <b>81,60</b>  |  |  |
| protezioni telaio / frame protector                                   | 13 | 16 | CARB1050 | <b>204,00</b> |  |  |
| protezioni telaio / frame protector                                   | 17 | 19 | CARB1051 | <b>216,00</b> |  |  |
| protezioni forcellone / swingarm protector                            | 13 | 16 | CARB1060 | <b>192,00</b> |  |  |
| protezioni forcellone / swingarm protector                            | 17 | 19 | CARB1061 | <b>204,00</b> |  |  |

|   |    |    |          |               |  |  |
|---|----|----|----------|---------------|--|--|
| <b>S 1000 RR</b>  |    |    |          |               |  |  |
| parafango ant. / front mudguard                                       | 09 | 18 | CARB1010 | <b>180,00</b> |  |  |
| parafango post. con copri catena / rear mudguard with chain protector | 09 | 18 | CARB1020 | <b>163,20</b> |  |  |
| coperchio frizione / clutch cover                                     | 09 | 14 | CARB1030 | <b>129,60</b> |  |  |
| coperchio frizione / clutch cover                                     | 15 | 18 | CARB1031 | <b>129,60</b> |  |  |
| coperchio alternatore / electric cover                                | 09 | 18 | CARB1040 | <b>108,00</b> |  |  |
| coperchio pick up / pick up cover                                     | 09 | 16 | CARB1018 | <b>81,60</b>  |  |  |
| protezioni telaio / frame protector                                   | 09 | 14 | CARB1050 | <b>204,00</b> |  |  |
| protezioni telaio / frame protector                                   | 15 | 18 | CARB1051 | <b>216,00</b> |  |  |
| protezioni forcellone / swingarm protector                            | 09 | 14 | CARB1060 | <b>192,00</b> |  |  |
| protezioni forcellone / swingarm protector                            | 15 | 18 | CARB1061 | <b>204,00</b> |  |  |
| tubi airbox / racing airducts   | 09 | 11 | CARB1019 | <b>132,00</b> |  |  |

|   |    |    |          |               |  |  |
|---|----|----|----------|---------------|--|--|
| <b>S 1000 RR</b>  |    |    |          |               |  |  |
| parafango ant. / front mudguard                                       | 19 | 20 | CARB1910 | <b>276,00</b> |  |  |
| coperchio pick up / pick up cover                                     | 19 | 20 | CARB1918 | <b>127,20</b> |  |  |
| parafango post. con copri catena / rear mudguard with chain protector | 19 | 20 | CARB1920 | <b>312,00</b> |  |  |
| coperchio frizione / clutch cover                                     | 19 | 20 | CARB1930 | <b>132,00</b> |  |  |
| coperchio alternatore / electric cover                                | 19 | 20 | CARB1940 | <b>120,00</b> |  |  |
| protezioni telaio / frame protector                                   | 19 | 20 | CARB1950 | <b>331,20</b> |  |  |
| protezioni forcellone / swingarm protector                            | 19 | 20 | CARB1960 | <b>302,40</b> |  |  |
| copri serbatoio / tank cover  | 19 | 20 | CARB1929 | <b>300,00</b> |  |  |



BMW

FINE SERIE - END STOCK

| Modello - Model  | Anno - Year |         | Codice - Code | €             | Codice - Code | € |
|--|-------------|---------|---------------|---------------|---------------|---|
|  | dal - from  | al - to | LUCIDO-SHINE  |               | OPACO-MATT    |   |
| <b>HYPERMOTARD 950</b>                                 |             |         |               |               |               |   |
| copri catena / chain cover                             | 19          | 20      | CARD0412      | <b>101,00</b> |               |   |
| parafango post. / rear mudguard                        | 19          | 20      | CARD0420      | <b>209,00</b> |               |   |
| protezioni forcellone / swingarm protector             | 19          | 20      | CARD0460      | <b>276,00</b> |               |   |
| copri serbatoio / tank cover                           | 19          | 20      | CARD0429      | <b>283,00</b> |               |   |
| cover teste L+R / head cover L+R                       | 19          | 20      | CARD0441      | <b>108,00</b> |               |   |
| paramani / handguards                                  | 19          | 20      | CARD0401      | <b>164,00</b> |               |   |
| coperture laterali scarico / side panels-exhaust       | 19          | 20      | CARD0402      | <b>350,00</b> |               |   |
| copertura laterale radiatore / side cover for radiator | 19          | 20      | CARD0425      | <b>293,00</b> |               |   |

|   |    |    |                 |               |  |  |
|---|----|----|-----------------|---------------|--|--|
| <b>PANIGALE 899</b>                                   |    |    |                 |               |  |  |
| parafango ant. / front mudguard                       | 13 | 15 | <b>CARD1010</b> | <b>192,00</b> |  |  |
| coperchio alternatore / electric cover                | 13 | 15 | <b>CARD1040</b> | <b>144,00</b> |  |  |
| protezione molla mono / rear shock absorber protector | 13 | 15 | <b>CARD1039</b> | <b>84,00</b>  |  |  |

|   |    |    |                 |               |  |  |
|---|----|----|-----------------|---------------|--|--|
| <b>PANIGALE 1199 / 1299</b>                     |    |    |                 |               |  |  |
| parafango ant. / front mudguard                 | 12 | 17 | <b>CARD1010</b> | <b>192,00</b> |  |  |
| parafango post. / rear mudguard                 | 12 | 17 | <b>CARD1020</b> | <b>168,00</b> |  |  |
| coperchio frizione / clutch cover               | 12 | 17 | <b>CARD1030</b> | <b>120,00</b> |  |  |
| coperchio alternatore / electric cover          | 12 | 17 | <b>CARD1040</b> | <b>144,00</b> |  |  |
| protezioni forcellone / swingarm protector      | 12 | 17 | <b>CARD1060</b> | <b>192,00</b> |  |  |
| copri catena / chain protector                  | 12 | 17 | <b>CARD1012</b> | <b>72,00</b>  |  |  |
| protezione corona / sprocket cover              | 12 | 17 | <b>CARD1013</b> | <b>84,00</b>  |  |  |
| protezione mono / rear shock absorber protector | 12 | 17 | <b>CARD1039</b> | <b>84,00</b>  |  |  |

|   |    |    |                |               |           |               |
|---|----|----|----------------|---------------|-----------|---------------|
| <b>PANIGALE V4</b>  |    |    |                |               |           |               |
| paratacchi in carbonio / carbon heel guards   | 18 | 20 | CARD0801       | <b>151,20</b> | CARD0801M | <b>151,20</b> |
| parafango ant. / front mudguard   | 18 | 20 | CARD0810       | <b>288,00</b> | CARD0810M | <b>288,00</b> |
| parafango post. / rear mudguard   | 18 | 20 | CARD0820       | <b>246,00</b> | CARD0820M | <b>246,00</b> |
| coperchio frizione / clutch cover   | 18 | 20 | CARD0830       | <b>139,20</b> | CARD0830M | <b>139,20</b> |
| coperchio alternatore / electric cover  | 18 | 20 | CARD0840       | <b>151,20</b> | CARD0840M | <b>151,20</b> |
| cover teste L+R / head cover L+R  | 18 | 20 | CARD0841       | <b>264,00</b> | CARD0841M | <b>264,00</b> |
| protezioni telaio / frame protection  | 18 | 20 | CARD0850       | <b>276,00</b> | CARD0850M | <b>276,00</b> |
| protezioni forcellone / swingarm protector  | 18 | 20 | CARD0860       | <b>271,20</b> | CARD0860M | <b>271,20</b> |
| slider in alluminio per protezione forcellone / alu-slider for carbon swingarm protection | 18 | 20 | CARD0861-01sil | <b>48,00</b>  |           |               |
| copri serbatoio totale / total tank cover   | 18 | 20 | CARD0827       | <b>444,00</b> | CARD0827M | <b>444,00</b> |
| copri serbatoio con cover chiave integrato / tank cover with key cover                    | 18 | 20 | CARD0828       | <b>293,00</b> | CARD0828M | <b>293,00</b> |
| copri serbatoio / tank cover  | 18 | 20 | CARD0829       | <b>220,80</b> | CARD0829M | <b>220,80</b> |
| fianchetti sotto serbatoio / sides under tank panels                                      | 18 | 20 | CARD0880       | <b>240,00</b> | CARD0880M | <b>240,00</b> |
| codone / tail   | 18 | 20 | CARD0890       | <b>355,20</b> | CARD0890M | <b>355,20</b> |
| deflettori laterali / side deflectors   | 18 | 20 | CARD0815       | <b>672,00</b> | CARD0815M | <b>672,00</b> |



PANIGALE V4  
CARD0827



PANIGALE V4  
CARD0841

FINE SERIE - END STOCK

| Modello - Model  | Anno - Year |         | Codice - Code | €             | Codice - Code | €             |
|--|-------------|---------|---------------|---------------|---------------|---------------|
|  | dal - from  | al - to | LUCIDO-SHINE  |               | OPACO-MATT    |               |
| <b>STREETFIGHTER V4</b>  |             |         |               |               |               |               |
| paratacchi in carbonio / carbon heel guards                            | 20          | 21      | CARD0801      | <b>151,20</b> | CARD0801M     | <b>151,20</b> |
| parafango ant. / front mudguard  | 20          | 21      | CARD0810      | <b>288,00</b> | CARD0810M     | <b>288,00</b> |
| parafango post. / rear mudguard  | 20          | 21      | CARD0820      | <b>246,00</b> | CARD0820M     | <b>246,00</b> |
| coperchio frizione / clutch cover                                      | 20          | 21      | CARD0730      | <b>139,20</b> | CARD0730M     | <b>139,20</b> |
| coperchio alternatore / electric cover                                 | 20          | 21      | CARD0840      | <b>151,20</b> | CARD0840M     | <b>151,20</b> |
| cover teste L+R / head cover L+R                                       | 20          | 21      | CARD0841      | <b>264,00</b> | CARD0841M     | <b>264,00</b> |
| protezioni telaio / frame protector                                    | 20          | 21      | CARD0750      | <b>276,00</b> | CARD0750M     | <b>276,00</b> |
| protezioni forcellone / swingarm protector                             | 20          | 21      | CARD0760      | <b>271,00</b> | CARD0760M     | <b>271,00</b> |
| copri serbatoio / tank cover   | 20          | 21      | CARD0729      | <b>230,40</b> | CARD0729M     | <b>230,40</b> |
| codone / tail  | 20          | 21      | CARD0890      | <b>355,20</b> | CARD0890M     | <b>355,20</b> |
| fianchetti sotto serbatoio / sides under tank panels                   | 20          | 21      | CARD0780      | <b>345,60</b> | CARD0780M     | <b>345,60</b> |
| deflettori laterali / side deflectors                                  | 20          | 21      | CARD0715      |               | CARD0715M     |               |
| copertura laterale superiore radiatore / upper side cover for radiator | 20          | 21      | CARD0725      | <b>238,00</b> | CARD0725M     | <b>238,00</b> |
| copertura laterale inferiore radiatore / lower side cover for radiator | 20          | 21      | CARD0726      | <b>217,00</b> | CARD0726M     | <b>217,00</b> |
| frontalino copri strumenti / tachometer support cover                  | 20          | 21      | CARD0770      | <b>192,00</b> | CARD0770M     | <b>192,00</b> |

DUCATI



FINE SERIE - END STOCK

| Modello - Model                                       | Anno - Year |         | Codice - Code | €      | Codice - Code |  | € |
|---|-------------|---------|---------------|--------|---------------|--|---|
|   | dal - from  | al - to | LUCIDO-SHINE  |        | OPACO-MATT    |  |   |
| <b>CB 1000 R</b>                                      |             |         |               |        |               |  |   |
| parafango ant. / front mudguard                       | 18          | 20      | CARH7710      | 276,00 |               |  |   |
| copri catena / chain cover                            | 18          | 20      | CARH7712      | 96,00  |               |  |   |
| protezione corona / sprocket protector                | 18          | 20      | CARH7713      | 72,00  |               |  |   |
| parafango post. / rear mudguard                       | 18          | 20      | CARH7720      | 180,00 |               |  |   |
| coperchio frizione-pick up / clutch cover - pick up   | 18          | 20      | CARH7730      | 129,60 |               |  |   |
| coperchio alternatore / electric cover                | 18          | 20      | CARH7740      | 108,00 |               |  |   |
| protezioni forcellone / swingarm protector            | 18          | 20      | CARH7760      | 108,00 |               |  |   |
| frontalino copri strumenti / tachometer support cover | 18          | 20      | CARH7770      | 91,20  |               |  |   |

HONDA

|  |    |    |          |        |  |  |  |
|--|----|----|----------|--------|--|--|--|
| <b>CBR 600 RR</b>                          |    |    |          |        |  |  |  |
| parafango ant. / front mudguard            | 07 | 16 | CARH6510 | 180,00 |  |  |  |
| parafango post. / rear mudguard            | 07 | 16 | CARH8920 | 132,00 |  |  |  |
| coperchio frizione / clutch cover          | 07 | 16 | CARH6530 | 129,60 |  |  |  |
| coperchio alternatore / electric cover     | 07 | 16 | CARH6540 | 96,00  |  |  |  |
| protezioni telaio / frame protector        | 07 | 16 | CARH6550 | 204,00 |  |  |  |
| protezioni forcellone / swingarm protector | 07 | 16 | CARH6560 | 180,00 |  |  |  |

|  |    |    |          |        |  |  |  |
|--|----|----|----------|--------|--|--|--|
| <b>CBR 1000 RR</b>                         |    |    |          |        |  |  |  |
| parafango ant. / front mudguard            | 08 | 16 | CARH1710 | 180,00 |  |  |  |
| copri catena / chain cover                 | 08 | 16 | CARH1712 | 108,00 |  |  |  |
| parafango post. / rear mudguard            | 08 | 11 | CARH7620 | 132,00 |  |  |  |
| parafango post. / rear mudguard            | 12 | 16 | CARH1720 | 168,00 |  |  |  |
| coperchio alternatore / electric cover     | 08 | 16 | CARH7640 | 108,00 |  |  |  |
| coperchio frizione / clutch cover          | 08 | 16 | CARH7630 | 129,60 |  |  |  |
| protezioni telaio / frame protector        | 08 | 16 | CARH7650 | 216,00 |  |  |  |
| protezioni forcellone / swingarm protector | 08 | 16 | CARH7660 | 184,80 |  |  |  |

|  |    |    |          |        |  |  |  |
|--|----|----|----------|--------|--|--|--|
| <b>CBR 1000 RR</b>                         |    |    |          |        |  |  |  |
| parafango ant. / front mudguard            | 17 | 19 | CARH1710 | 180,00 |  |  |  |
| copri catena / chain cover                 | 17 | 19 | CARH1712 | 108,00 |  |  |  |
| parafango post. / rear mudguard            | 17 | 19 | CARH1720 | 168,00 |  |  |  |
| coperchio frizione / clutch cover          | 17 | 19 | CARH1730 | 129,60 |  |  |  |
| coperchio alternatore / electric cover     | 17 | 19 | CARH1740 | 108,00 |  |  |  |
| protezioni telaio / frame protector        | 17 | 19 | CARH1750 | 220,80 |  |  |  |
| protezioni forcellone / swingarm protector | 17 | 19 | CARH1760 | 196,80 |  |  |  |

NEW!

|  |    |    |          |        |  |  |  |
|--|----|----|----------|--------|--|--|--|
| <b>CBR 1000 RR-R</b>                                 |    |    |          |        |  |  |  |
| parafango ant. / front mudguard                      | 20 | 21 | CARH2110 | 276,00 |  |  |  |
| parafango post. / rear mudguard                      | 20 | 21 | CARH2120 | 223,00 |  |  |  |
| coperchio pick up / pick up cover                    | 20 | 21 | CARH2118 |        |  |  |  |
| coperchio frizione / clutch cover                    | 20 | 21 | CARH2130 |        |  |  |  |
| coperchio alternatore / electric cover               | 20 | 21 | CARH2140 |        |  |  |  |
| protezioni telaio / frame protector                  | 20 | 21 | CARH2150 |        |  |  |  |
| protezioni forcellone / swingarm protector           | 20 | 21 | CARH2160 |        |  |  |  |
| fianchetti sotto serbatoio / sides under tank panels | 20 | 21 | CARH2180 |        |  |  |  |
| copri serbatoio / tank cover                         | 20 | 21 | CARH2129 |        |  |  |  |



HONDA CB 1000 R  
CARH7710



HONDA CB 1000 R  
CARH7720

| Modello - Model                                       | Anno - Year |         | Codice - Code | €             | Codice - Code |  | € |
|---|-------------|---------|---------------|---------------|---------------|--|---|
|   | dal - from  | al - to | LUCIDO-SHINE  |               | OPACO-MATT    |  |   |
| <b>ZX6R / 636</b>                                     |             |         |               |               |               |  |   |
| parafango ant. / front mudguard                       | 09          | 18      | CARK9610      | <b>180,00</b> |               |  |   |
| parafango post. / rear mudguard                       | 09          | 20      | CARK9520      | <b>144,00</b> |               |  |   |
| coperchio frizione / clutch cover                     | 09          | 20      | CARK9530      | <b>120,00</b> |               |  |   |
| coperchio alternatore / electric cover                | 09          | 20      | CARK9540      | <b>96,00</b>  |               |  |   |
| coperchio pick up / pick up cover                     | 09          | 20      | CARK9518      | <b>120,00</b> |               |  |   |
| protezioni telaio / frame protectors                  | 09          | 20      | CARK9550      | <b>192,00</b> |               |  |   |
| protezioni forcellone / swingarm protector            | 09          | 20      | CARK9560      | <b>180,00</b> |               |  |   |
| copri catena / chain protector                        | 09          | 20      | CARK9512      | <b>108,00</b> |               |  |   |
| <b>ZX10R</b>  |             |         |               |               |               |  |   |
| parafango ant. / front mudguard                       | 11          | 15      | CARK9610      | <b>180,00</b> |               |  |   |
| parafango ant. / front mudguard                       | 16          | 20      | CARK9810      | <b>288,00</b> |               |  |   |
| parafango post. / rear mudguard                       | 11          | 20      | CARK9620      | <b>144,00</b> |               |  |   |
| copri catena / chain protector                        | 11          | 20      | CARK9612      | <b>108,00</b> |               |  |   |
| coperchio frizione / clutch cover                     | 11          | 20      | CARK9630      | <b>120,00</b> |               |  |   |
| coperchio alternatore / electric cover                | 11          | 20      | CARK9640      | <b>108,00</b> |               |  |   |
| coperchio pick up / pick up cover                     | 11          | 20      | CARK9618      | <b>108,00</b> |               |  |   |
| protezioni telaio / frame protector                   | 11          | 15      | CARK9650      | <b>211,20</b> |               |  |   |
| protezioni telaio / frame protector                   | 16          | 20      | CARK9850      | <b>220,80</b> |               |  |   |
| protezioni forcellone / swingarm protector            | 11          | 15      | CARK9660      | <b>187,20</b> |               |  |   |
| protezioni forcellone / swingarm protector            | 16          | 20      | CARK9860      | <b>196,80</b> |               |  |   |
| <b>Z900</b>   |             |         |               |               |               |  |   |
| parafango ant. / front mudguard                       | 17          | 20      | CARK8010      | <b>276,00</b> |               |  |   |
| parafango post. / rear mudguard                       | 17          | 20      | CARK8020      | <b>246,00</b> |               |  |   |
| coperchio frizione / clutch cover                     | 17          | 20      | CARK8030      | <b>124,80</b> |               |  |   |
| coperchio alternatore / electric cover                | 17          | 20      | CARK8040      | <b>108,00</b> |               |  |   |
| coperchio pick up / pick up cover                     | 17          | 20      | CARK8018      | <b>91,20</b>  |               |  |   |
| frontalino copri strumenti / tachometer support cover | 17          | 20      | CARK8070      | <b>144,00</b> |               |  |   |



# COMPONENTI IN CARBONIO

FINE SERIE - END STOCK

| Modello - Model                 | Anno - Year |         | Codice - Code   |  | €      | Codice - Code    |  | €      |
|---------------------------------|-------------|---------|-----------------|--|--------|------------------|--|--------|
|                                 | dal - from  | al - to | LUCIDO-SHINE    |  |        | OPACO-MATT       |  |        |
| <b>B3 / F3 / RIVALE</b>         |             |         |                 |  |        |                  |  |        |
| parafango ant. / front mudguard | 12          | 19      | <b>CARM1010</b> |  | 204,00 | <b>CARM1010M</b> |  | 204,00 |
| parafango post. / rear mudguard | 12          | 19      | <b>CARM1020</b> |  | 156,00 | <b>CARM1020M</b> |  | 168,00 |
| copri catena / chain cover      | 12          | 19      | <b>CARM1012</b> |  | 84,00  | <b>CARM1012M</b> |  | 96,00  |

MV AGUSTA



KAWASAKI Z900  
CARK8010



KAWASAKI Z900  
CARK8020



KAWASAKI Z900  
CARK8070



Renzi Corse



FINE SERIE - END STOCK

| Modello - Model                            | Anno - Year |         | Codice - Code | €      | Codice - Code |        | € |
|--|-------------|---------|---------------|--------|---------------|--------|---|
|  | dal - from  | al - to | LUCIDO-SHINE  |        | OPACO-MATT    |        |   |
| <b>GSX-R 600 / 750</b>                     |             |         |               |        |               |        |   |
| parafango ant. / front mudguard            | 11          | 17      | CARS6110      | 180,00 |               |        |   |
| parafango post. / rear mudguard            | 11          | 17      | CARS6120      | 148,80 |               |        |   |
| coperchio frizione / clutch cover          | 11          | 17      | CARS8030      | 132,00 |               |        |   |
| coperchio alternatore / electric cover     | 11          | 17      | CARS6040      | 120,00 |               |        |   |
| protezioni telaio / frame protection       | 11          | 17      | CARS6150      | 216,00 |               |        |   |
| protezioni forcellone / swingarm protector | 11          | 17      | CARS6160      | 180,00 |               |        |   |
| <b>GSX-R 1000</b>                          |             |         |               |        |               |        |   |
| parafango ant. / front mudguard            | 09          | 16      | CARS6410      | 180,00 |               |        |   |
| parafango post. / rear mudguard            | 09          | 16      | CARS6420      | 148,80 |               |        |   |
| coperchio frizione / clutch cover          | 09          | 16      | CARS6430      | 132,00 |               |        |   |
| coperchio alternatore / electric cover     | 09          | 16      | CARS6440      | 108,00 |               |        |   |
| protezioni telaio / frame protector        | 09          | 16      | CARS6450      | 216,00 |               |        |   |
| protezioni forcellone / swingarm protector | 09          | 16      | CARS6460      | 180,00 |               |        |   |
| <b>GSX-R 1000 / R</b>                      |             |         |               |        |               |        |   |
| parafango ant. / front mudguard            | 17          | 20      | CARS6510      | 276,00 | CARS6510M     | 276,00 |   |
| parafango post. / rear mudguard            | 17          | 20      | CARS6521      | 172,80 | CARS6521M     | 180,00 |   |
| coperchio frizione / clutch cover          | 17          | 20      | CARS6530      | 129,60 | CARS6530M     | 144,00 |   |
| coperchio alternatore / electric cover     | 17          | 20      | CARS6540      | 108,00 | CARS6540M     | 120,00 |   |
| protezioni telaio / frame protector        | 17          | 20      | CARS6550      | 220,80 | CARS6550M     | 244,80 |   |
| protezioni forcellone / swingarm protector | 17          | 20      | CARS6560      | 196,80 | CARS6560M     | 220,80 |   |
| copri catena / chain cover                 | 17          | 20      | CARS6512      | 115,20 | CARS6512M     | 127,20 |   |
| copri serbatoio / tank cover               | 17          | 20      | CARS6529      | 288,00 | CARS6529M     | 312,00 |   |
| tubi air box racing / racing airducts      | 17          | 20      | CARS6519      | 334,00 |               |        |   |

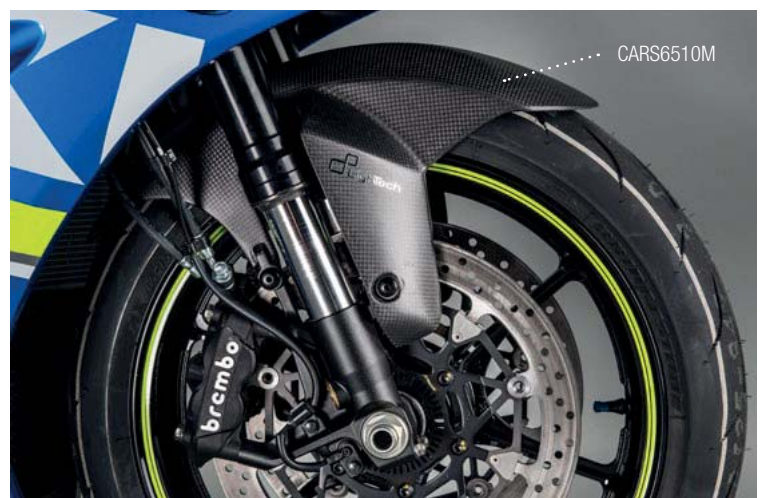

# COMPONENTI IN CARBONIO

200 CARBON PARTS

| Modello - Model                 | Anno - Year |         | Codice - Code | €             | Codice - Code |            | € |
|---------------------------------|-------------|---------|---------------|---------------|---------------|------------|---|
|                                 | dal - from  | al - to |               |               | LUCIDO-SHINE  | OPACO-MATT |   |
| <b>MT - 09 / MT 09 - Tracer</b> |             |         |               |               |               |            |   |
| parafango ant. / front mudguard | 13          | 20      | CARY8910      | <b>252,00</b> |               |            |   |
| parafango post. / rear mudguard | 13          | 20      | CARY8920      | <b>144,00</b> |               |            |   |

|  |    |    |          |               |  |  |  |
|--|----|----|----------|---------------|--|--|--|
| <b>MT-10</b>                               |    |    |          |               |  |  |  |
| parafango ant. / front mudguard            | 16 | 20 | CARY5010 | <b>288,00</b> |  |  |  |
| parafango post. / rear mudguard            | 16 | 20 | CARY5020 | <b>156,00</b> |  |  |  |
| copri catena / chain cover                 | 16 | 20 | CARY5012 | <b>84,00</b>  |  |  |  |
| coperchio frizione / clutch cover          | 16 | 20 | CARY5130 | <b>148,80</b> |  |  |  |
| coperchio alternatore / electric cover     | 16 | 20 | CARY5140 | <b>108,00</b> |  |  |  |
| coperchio pick up / pick up cover          | 16 | 20 | CARY5018 | <b>91,20</b>  |  |  |  |
| protezioni telaio / frame protector        | 16 | 20 | CARY5050 | <b>220,80</b> |  |  |  |
| protezioni forcellone / swingarm protector | 16 | 20 | CARY5060 | <b>196,80</b> |  |  |  |

|  |    |    |          |               |  |  |  |
|--|----|----|----------|---------------|--|--|--|
| <b>YZF R6</b>                              |    |    |          |               |  |  |  |
| parafango ant. / front mudguard            | 06 | 16 | CARY9910 | <b>168,00</b> |  |  |  |
| parafango post. / rear mudguard            | 06 | 16 | CARY9920 | <b>120,00</b> |  |  |  |
| coperchio frizione / clutch cover          | 06 | 16 | CARY9930 | <b>120,00</b> |  |  |  |
| coperchio alternatore / electric cover     | 06 | 16 | CARY9940 | <b>108,00</b> |  |  |  |
| coperchio pick up / pick up cover          | 06 | 16 | CARY9918 | <b>91,20</b>  |  |  |  |
| protezioni telaio / frame protection       | 06 | 16 | CARY9950 | <b>192,00</b> |  |  |  |
| protezioni forcellone / swingarm protector | 06 | 16 | CARY9960 | <b>180,00</b> |  |  |  |

|  |    |    |          |               |  |  |  |
|--|----|----|----------|---------------|--|--|--|
| <b>YZF R6</b>                              |    |    |          |               |  |  |  |
| parafango ant. / front mudguard            | 17 | 20 | CARY5010 | <b>288,00</b> |  |  |  |
| copri catena / chain cover                 | 17 | 20 | CARY9912 | <b>100,80</b> |  |  |  |
| parafango post. / rear mudguard            | 17 | 20 | CARY9920 | <b>120,00</b> |  |  |  |
| coperchio frizione / clutch cover          | 17 | 20 | CARY9930 | <b>120,00</b> |  |  |  |
| coperchio alternatore / electric cover     | 17 | 20 | CARY9940 | <b>108,00</b> |  |  |  |
| coperchio pick up / pick up cover          | 17 | 20 | CARY9918 | <b>91,20</b>  |  |  |  |
| protezioni telaio / frame protection       | 17 | 20 | CARY9951 | <b>216,00</b> |  |  |  |
| protezioni forcellone / swingarm protector | 17 | 20 | CARY9961 | <b>180,00</b> |  |  |  |
| coperchio serbatoio / tank cover           | 17 | 20 | CARY9929 | <b>276,00</b> |  |  |  |
| protezioni serbatoio / tank protector      | 17 | 20 | CARY9990 | <b>115,20</b> |  |  |  |

NEW!

YAMAHA

NEW!

NEW!



FINE SERIE - END STOCK

| Modello - Model   | Anno - Year |         | Codice - Code | €      | Codice - Code |  | € |
|---|-------------|---------|---------------|--------|---------------|--|---|
|   | dal - from  | al - to | LUCIDO-SHINE  |        | OPACO-MATT    |  |   |
| <b>R1</b>   |             |         |               |        |               |  |   |
| parafango ant. / front mudguard                             | 15          | 20      | CARY5010      | 288,00 |               |  |   |
| parafango post. / rear mudguard                             | 15          | 20      | CARY5020      | 156,00 |               |  |   |
| copri catena / chain cover                                  | 15          | 20      | CARY5012      | 84,00  |               |  |   |
| NEW! coperchio frizione / clutch cover                      | 15          | 16      | CARY5030      | 148,80 |               |  |   |
| coperchio frizione / clutch cover                           | 17          | 19      | CARY5130      | 148,80 |               |  |   |
| coperchio alternatore / electric cover                      | 15          | 20      | CARY5040      | 124,80 |               |  |   |
| coperchio pick up / pick up cover                           | 15          | 20      | CARY5018      | 91,20  |               |  |   |
| protezioni telaio / frame protector                         | 15          | 20      | CARY5050      | 220,80 |               |  |   |
| protezioni forcellone / swingarm protector                  | 15          | 20      | CARY5060      | 196,80 |               |  |   |
| fianchetti laterali sotto serbatoio / side under tank panel | 15          | 19      | CARY5080      | 192,00 |               |  |   |
| coperchio serbatoio / tank cover                            | 15          | 19      | CARY5029      | 288,00 |               |  |   |

|  |    |    |          |        |  |  |  |
|--|----|----|----------|--------|--|--|--|
| <b>R1</b>                                  |    |    |          |        |  |  |  |
| parafango ant. / front mudguard            | 20 | 20 | CARY5010 | 288,00 |  |  |  |
| parafango post. / rear mudguard            | 20 | 20 | CARY5020 | 156,00 |  |  |  |
| copri catena / chain cover                 | 20 | 20 | CARY5012 | 84,00  |  |  |  |
| NEW! coperchio frizione / clutch cover     | 20 | 20 | CARY5130 | 148,80 |  |  |  |
| coperchio alternatore / electric cover     | 20 | 20 | CARY5040 | 124,80 |  |  |  |
| coperchio pick up / pick up cover          | 20 | 20 | CARY5018 | 91,20  |  |  |  |
| protezioni telaio / frame protector        | 20 | 20 | CARY5050 | 220,80 |  |  |  |
| protezioni forcellone / swingarm protector | 20 | 20 | CARY5060 | 196,80 |  |  |  |

|   |    |    |          |        |  |  |  |
|---|----|----|----------|--------|--|--|--|
| <b>R1 - M</b>                                   |    |    |          |        |  |  |  |
| NEW! parafango ant. / front mudguard            | 20 | 20 | CARY5110 | 288,00 |  |  |  |
| parafango post. / rear mudguard                 | 20 | 20 | CARY5020 | 156,00 |  |  |  |
| NEW! copri catena / chain cover                 | 20 | 20 | CARY5012 | 84,00  |  |  |  |
| NEW! coperchio serbatoio / tank cover           | 20 | 20 | CARY5129 | 331,00 |  |  |  |
| coperchio frizione / clutch cover               | 20 | 20 | CARY5130 | 148,80 |  |  |  |
| coperchio alternatore / electric cover          | 20 | 20 | CARY5040 | 124,80 |  |  |  |
| coperchio pick up / pick up cover               | 20 | 20 | CARY5018 | 91,20  |  |  |  |
| protezioni telaio / frame protector             | 20 | 20 | CARY5050 | 220,80 |  |  |  |
| NEW! protezioni forcellone / swingarm protector | 20 | 20 | CARY5060 | 196,80 |  |  |  |
| protezioni serbatoio / tank protector           | 20 | 20 | CARY5190 | 115,20 |  |  |  |

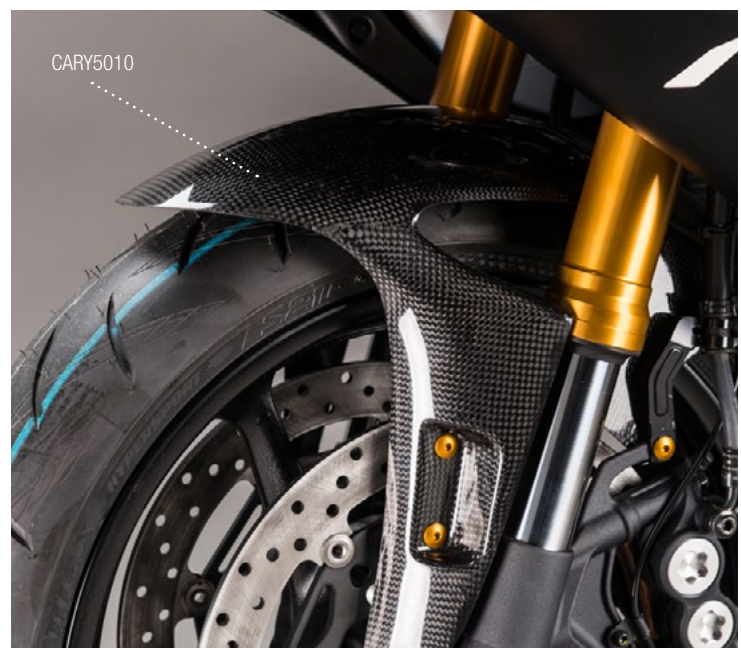

## COMPONENTI IN CARBONIO

202 CARBON PARTS

| Modello - Model   | Anno - Year |         | Codice - Code |  | €             | Codice - Code |  | €             |
|---|-------------|---------|---------------|--|---------------|---------------|--|---------------|
|   | dal - from  | al - to | LUCIDO-SHINE  |  |               | OPACO-MATT    |  |               |
| <b>T-MAX 500 / 530</b>  |             |         |               |  |               |               |  |               |
| parafango ant. / front mudguard   | 08          | 14      | CARY4610      |  | <b>168,00</b> | CARY4610M     |  | <b>184,80</b> |
| parafango ant. / front mudguard   | 15          | 16      | CARY4710      |  | <b>168,00</b> | CARY4710M     |  | <b>184,80</b> |
| protezioni forcellone / swingarm protector  | 12          | 16      | CARY4660      |  | <b>144,00</b> | CARY4660M     |  | <b>156,00</b> |
| copri cinghia / belt protector  | 12          | 16      | CARY4612      |  | <b>108,00</b> | CARY4612M     |  | <b>120,00</b> |
| <b>T-MAX 530 / 560</b>  |             |         |               |  |               |               |  |               |
| copri cinghia superiore / upper belt cover  | 17          | 20      | CARY4912      |  | <b>184,00</b> | CARY4912M     |  | <b>184,00</b> |
| copri cinghia inferiore / lower belt cover  | 17          | 20      | CARY4914      |  | <b>173,00</b> | CARY4914M     |  | <b>173,00</b> |
|  Pinna protezione catena / Chain protection |             |         | CAR001        |  | <b>55,20</b>  |               |  |               |
| Covogliatori aria per raffreddamento pinze freno / Air conveyors for brake caliper  |             |         | CAR007        |  | <b>192,00</b> |               |  |               |

YAMAHA



 NEW!

CAR007





**CAVALLETTI  
STANDS**

---

**RACING & BOX**

NEW!



kg 2,1

Colori disponibili: nero  
Available colours: black

Cavallo posteriore in carbonio con forchette  
Carbon rear stand with forks

RSC001F € 540,00

Cavallo posteriore in carbonio con rulli  
Carbon rear stand with rollers

RSC001R € 540,00

Cavallo anteriore in carbonio sotto piastra  
Carbon front stand under plate

RSC002

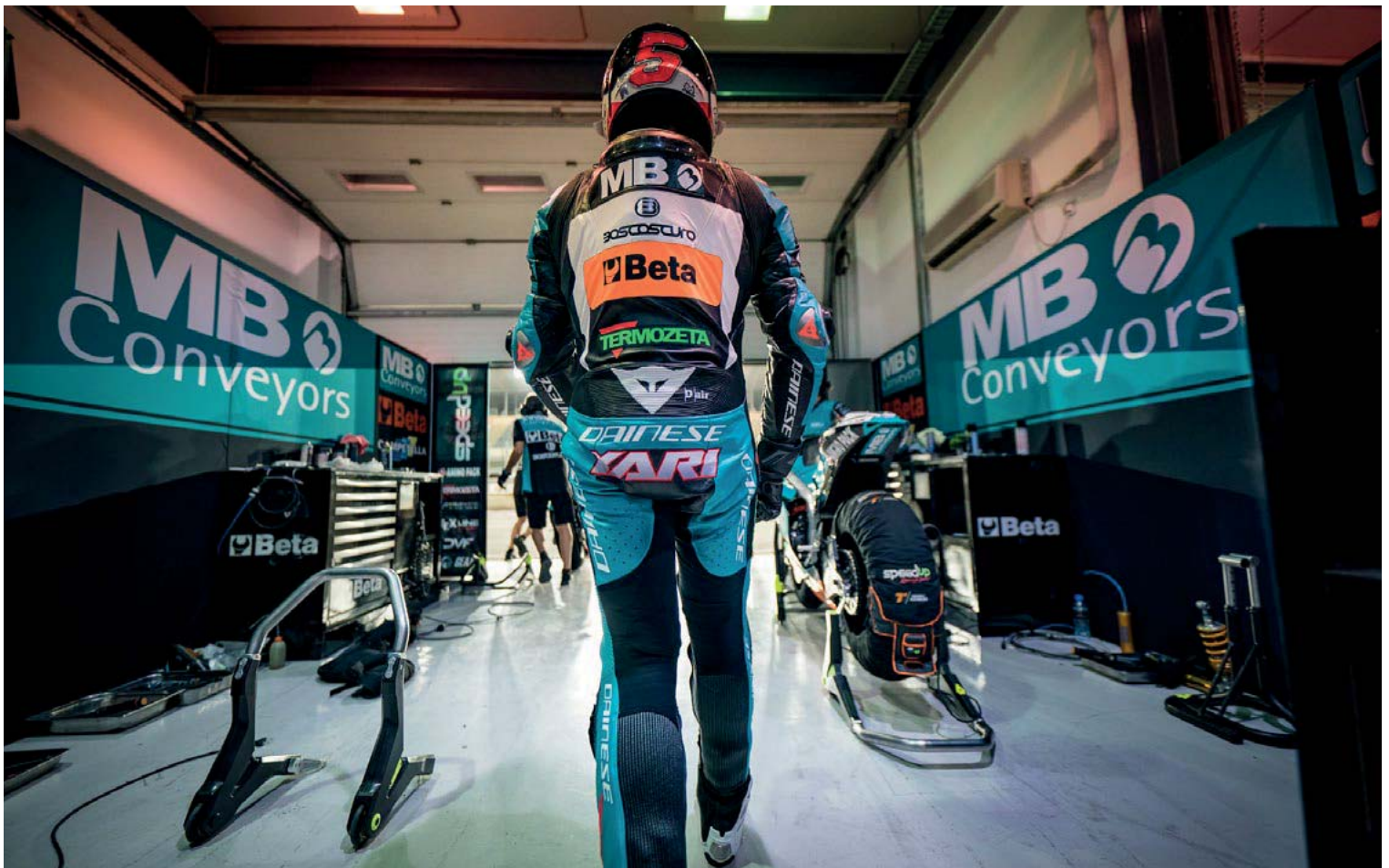



 kg 2,7

Colori disponibili: nero, rosso, blu, verde  
Available colours: black, red, blu, green

**FINE SERIE - END STOCK**

Cavalletto posteriore in alluminio con forchette  
Aluminium rear stand with forks

**RSA23F € 198,00**

Cavalletto posteriore in alluminio con rulli  
Aluminium rear stand with rollers

**RSA23R € 198,00**



 kg 4,5

Cavalletto anteriore centrale in alluminio  
Aluminium front triple tree lift

**RSA20 € 247,00**

 kg 6,3

Perno inox per cavalletto / Stainless steel pin for stand



| Modello - Model                      | Ø    | Codice - Code | €    |
|--------------------------------------|------|---------------|------|
| RSA20                                | 12,7 | PIN001        | 6,90 |
| RSA20 - BMW S1000RR                  | 15,7 | PIN002        | 6,90 |
| RSA20 - Yamaha R1 / R6               | 16,5 | PIN007        | 6,90 |
| RSA20 - Aprilia RSV4                 | 19,8 | PIN003        | 6,90 |
| RSA20 - Kawasaki Ninja 400           | 22,0 | PIN004        | 6,90 |
| RSA20                                | 24,0 | PIN005        | 6,90 |
| RSA20 - Kawasaki ZX10R / ZX6R / Z900 | 27,7 | PIN006        | 6,90 |
| RSA20 - Yamaha R3                    | 17,2 | PIN008        | 6,90 |
| RSA20 - Suzuki GSXR1000              | 15,9 | PIN009        | 6,90 |



 kg 2,3

Cavalletto anteriore in ferro  
Iron front stand

RSF008 € 54,00



 kg 3,2

Cavalletto anteriore in ferro con attacco sotto pinze freno  
Iron front stand with attachment under brake calipers

RSF042 € 98,00



RSA23F

RSF042





 kg 3,0

Cavalletto posteriore in ferro a 2 ruote con forchette  
Iron rear stand with 2 wheels and forks

RSF036 € 43,50



 kg 3,1

Cavalletto posteriore in ferro a 2 ruote con forchette  
Iron rear stand with 2 wheels and forks



RSF045F € 68,00

Cavalletto posteriore in ferro a 2 ruote con pattini  
Iron rear stand with 2 wheels and sliding blocks



RSF045P € 78,00

Cavalletto posteriore in ferro a 2 ruote con rulli  
Iron rear stand with 2 wheels and rollers



RSF045R € 88,00



 kg 2,9

Cavalletto anteriore in ferro  
Iron front stand

RSF22 € 95,50



 kg 4,5

Cavalletto posteriore in ferro con forchette  
Iron rear stand with forks



RSF21F € 109,00

Cavalletto posteriore in ferro con pattini  
Iron rear stand with sliding blocks



RSF21P € 120,00

Cavalletto posteriore in ferro con rulli  
Iron rear stand with rollers



RSF21R € 131,00



 kg 5,1

Cavalletto posteriore monobraccio (senza perno)  
Iron one armed rear stand (without pin)

RSF046 € 166,50

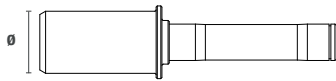

Perno per cavalletto monobraccio in ferro / Pin for iron one armed rear stand

| ø perno - ø pin | Codice - Code | €     |
|-----------------|---------------|-------|
| 42,7            | RSF26         | 25,50 |
| 28,4            | RSF27         | 25,50 |
| 26,8            | RSF28         | 25,50 |
| 40,6            | RSF29         | 25,50 |
| 25,7            | RSF30         | 25,50 |
| 53,5            | RSF37         | 25,50 |
| 18,0            | RSF38         | 25,50 |
| 27,7            | RSF39         | 25,50 |

Applicazioni perni per cavalletti monobraccio  
Pins application list for one armed rear stand

| Modello - Model                             | Ø    | Codice - Code |
|---|------|---------------|
| BMW R 1200 GS (2003 - 2012 ) pin. DX        | 53,5 | RSF37         |
| BMW R 1200 GS (2013 - 2017 ) pin. SX        | 53,5 | RSF37         |
| BMW R nine T                                | 53,5 | RSF37         |
| DUCATI 848 / 848 EVO / 748                  | 25,7 | RSF30         |
| DUCATI 1098 / 1198                          | 40,6 | RSF29         |
| DUCATI Panigale 1199 / 1299 / V4 / V2       | 40,6 | RSF29         |
| DUCATI 996 / 998                            | 25,7 | RSF30         |
| DUCATI S2R / S4R                            | 25,7 | RSF30         |
| DUCATI Monster 796                          | 25,7 | RSF30         |
| DUCATI Monster 1100                         | 25,7 | RSF30         |
| DUCATI Monster 1200 / 1200R                 | 40,6 | RSF29         |
| DUCATI Multistrada 1100                     | 25,7 | RSF30         |
| DUCATI Multistrada 1200                     | 40,6 | RSF29         |
| DUCATI Hypermotard 796/1100/821/939/959/950 | 25,7 | RSF30         |
| DUCATI Streetfighter 848 / 1100             | 25,7 | RSF30         |
| DUCATI Streetfighter 1098 S                 | 40,6 | RSF29         |
| DUCATI Streetfighter V4 / S                 | 40,6 | RSF29         |
| DUCATI Diavel                               | 40,6 | RSF29         |
| HONDA CB 1000 R (2008 - 2017)               | 28,4 | RSF27         |
| HONDA CB 1000 R (2018)                      | 18,0 | RSF38         |
| HONDA VFR 800                               | 28,4 | RSF27         |
| KTM Superduke 1290 R                        | 27,7 | RSF39         |
| MV Brutale                                  | 42,7 | RSF26         |
| MV F4 / F3                                  | 42,7 | RSF26         |
| TRIUMPH Speed Triple 1050                   | 26,8 | RSF28         |





Cavalletto componibile posteriore in ferro a 4 ruote  
Modular iron rear stand with 4 wheels

RSF038 **€ 66,50**



Cavalletto componibile posteriore in ferro a 4 ruote con forchette  
Modular iron rear stand with 4 wheels and forks



RSF039F **€ 73,00**

Cavalletto componibile posteriore in ferro a 4 ruote con pattini  
Modular iron rear stand with 4 wheels and sliding blocks



RSF039P **€ 83,00**

Cavalletto componibile posteriore in ferro a 4 ruote con rulli  
Modular iron rear stand with 4 wheels and rollers



RSF039R **€ 94,00**



Coppia cavalletti sfilabili h 380 / 560 in alluminio  
Pair of aluminium extensible stands h 380 / 560

RSA002 **€ 161,00**



Coppia cavalletti sfilabili h 670 / 940 in alluminio  
Pair of aluminium extensible stands h 670 / 940

RSA003 **€ 165,00**

**RICAMBI PER CAVALLETTI**  
STANDS SPARE PARTS



Forchette  
Forks

RSF23 **€ 15,50**

a coppia - for pair



Pattini  
Sliding blocks

RSF24 **€ 21,00**

a coppia - for pair



Rulli  
Rollers

RSF25 **€ 26,00**

a coppia - for pair



Ruote  
Wheels

RW001 **€ 15,50**

a coppia - for pair



kg 18,00 - Dimension: L1340 x P450 H 1400

Carrello porta cerchi in alluminio  
Aluminium rims carrier

RSA13 € 455,00



kg 14,00 - Dimension: L1440 x P500 H 1300

Rastrelliera porta cerchi in alluminio con 10 postazioni  
Aluminium rims rack with 10 positions

RSA14 € 446,00



kg 16,00 - Dimension: L2100 x P630 H 450

Banco portamoto in carbonio  
Carbon bench table

FINE SERIE - END STOCK

RSA001 € 1.200,00

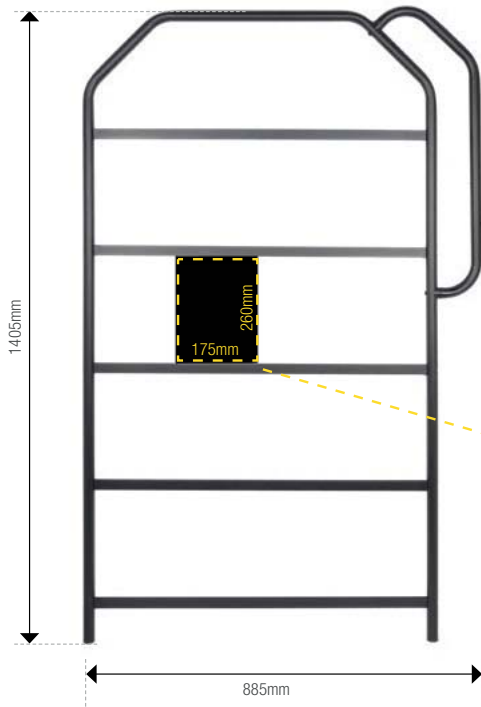

kg 2,2

Pitboard in alluminio verniciato nero  
Aluminium pitboard - black painted

TTG004 € 280,00

completa di 50 tabelle senza lettere e cifre  
with 50 tables without letters and numbers

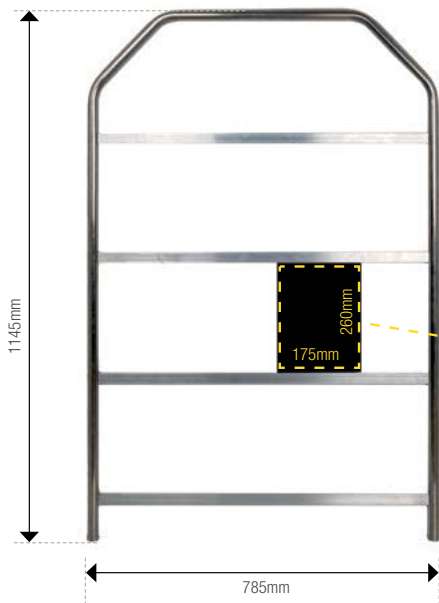

kg 1,5

Pitboard in alluminio NON verniciato  
Aluminium pitboard – uncoated aluminium

TTG005 € 172,00

completa di 36 tabelle senza lettere e cifre  
with 36 tables without letters and numbers



Tabella in PVC (minimo ordinabile 10 pz.)  
PVC time table (minimum required 10 pcs)

TTG004-08 € 2,60

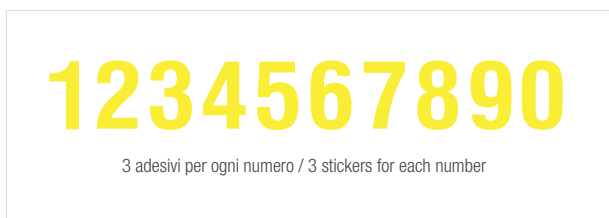

+



# SERBATOIO RIFORMIMENTO RAPIDO

212 FAST FUEL CANISTER



Colori disponibili: nero + rosso.  
Available colours: black + red.

| Modello - Model   | Codice - Code | colore serbatoio - fuel canister colour | €      |
|-------------------|---------------|---|--------|
| 5 LITRI / litres  | SER01         | nero / black                            | 502,00 |
| 10 LITRI / litres | SER02         | nero / black                            | 502,00 |



Colori disponibili: nero + rosso.  
Available colours: black + red.

| Modello - Model   | Codice - Code | colore serbatoio - fuel canister colour | €      |
|-------------------|---------------|---|--------|
| 5 LITRI / litres  | SER04         | nero / black                            | 502,00 |
| 10 LITRI / litres | SER05         | nero / black                            | 502,00 |





**Rain**

SAPR001 € 36,50

Colori disponibili: rosso / Available colours: red

a coppia - for pair



Ricambio / Spare part

RSAPR001 € 7,90

a pezzo - for piece



**Filler**

SAPF € 21,00

Colori disponibili: rosso, blu, bianco, nero, giallo  
Available colours: red, blue, white, yellow, black

a coppia - for pair



**Nuke**

SAPN € 27,00

Colori disponibili: nero  
Available colours: black

a coppia - for pair



**Dropper**

SAPDR0 € 21,00

Colori disponibili: rosso, blu, bianco, nero, giallo  
Available colours: red, blue, white, yellow, black

a coppia - for pair



**Leather**

SAPL € 41,60

Cuoio - Leather

a coppia - for pair

BORN  
TO BE  
MOTO

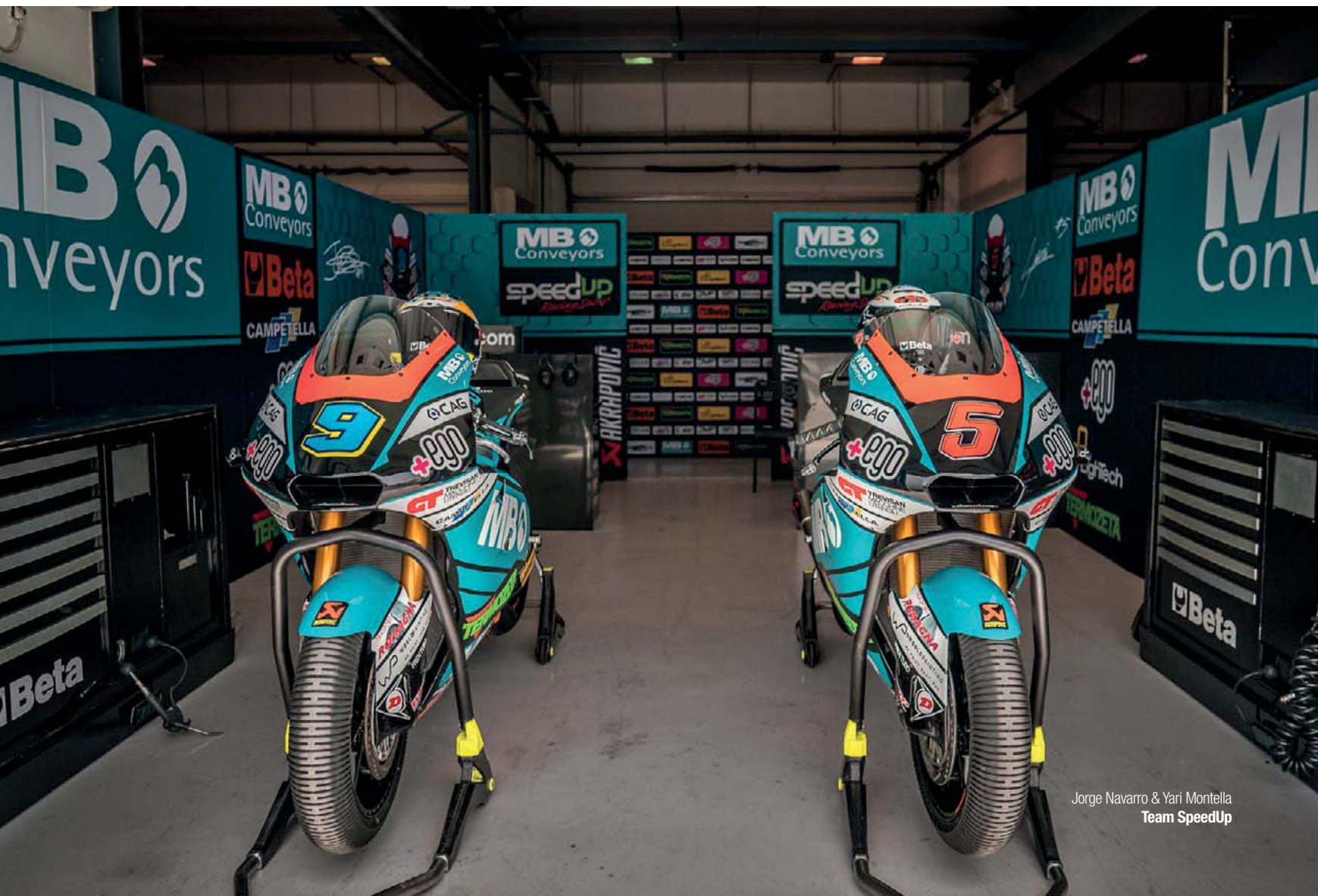



**ADESIVI  
STICKERS**



# ADESIVO PER SERBATOIO

216 TANK PAD



Protezione serbatoio trasparente  
Transparent tank protection sticker

STK123

€ 13,70

FLAG ITALIA - ITALY FLAG

a pezzo  
for piece



Protezione serbatoio nero  
Black tank protection sticker

STK124

€ 13,70

FLAG ITALIA - ITALY FLAG

a pezzo  
for piece



Protezione serbatoio texture carbonio  
Carbon texture tank protection sticker

STK126

€ 13,70

FLAG ITALIA - ITALY FLAG

a pezzo  
for piece



Protezione serbatoio nero  
Black tank protection sticker

STK125

€ 13,70

FLAG ITALIA - ITALY FLAG

a pezzo  
for piece





L130 x H190

Protezione serbatoio nero  
Black tank protection sticker

STK089

€ 16,30

FLAG ITALIA - ITALY FLAG

a pezzo  
for piece



L130 x H190

Protezione serbatoio trasparente  
Transparent tank protection sticker

STK090

€ 13,70

a pezzo  
for piece



L130 x H190

Protezione serbatoio fumè  
Smoked tank protection sticker

STK091

€ 13,70

a pezzo  
for piece



L130 x H190

Protezione serbatoio nero metallizzato  
Metallic black tank protection sticker

STK092

€ 13,70

a pezzo  
for piece



L130 x H190

Protezione serbatoio texture carbonio  
Carbon texture tank protection sticker

STK093

€ 13,70

a pezzo  
for piece



L130 x H190

Protezione serbatoio texture carbonio  
Carbon texture tank protection sticker

STK113

€ 13,70

CUSTOM LIGHTTECH

a pezzo  
for piece





L115 x H210

Protezione serbatoio slim  
Slim tank protection sticker

STK094

**€ 12,20**

TRANSPARENT

a pezzo  
for piece



L115 x H210

Protezione serbatoio slim  
Slim tank protection sticker

STK095

**€ 12,20**

METALLIC BLACK

a pezzo  
for piece



L115 x H210

Protezione serbatoio slim  
Slim tank protection sticker

STK096

**€ 12,20**

CARBON TEXTURE

a pezzo  
for piece



L115 x H215

Protezione serbatoio flat  
Flat tank protection sticker

STK097

**€ 7,40**

CARBON TEXTURE

a pezzo  
for piece



L130 x H185

Protezione serbatoio full  
Full tank protection sticker

STK098

**€ 19,90**

CARBON TEXTURE

a pezzo  
for piece



L105 x H175

Protezione serbatoio in fibra di carbonio  
Carbon fiber tank protection sticker

STK121

**€ 50,70**

CARBON TEXTURE

a pezzo  
for piece



L85 x H146

Protezione serbatoio mini  
Mini tank protection sticker

STK099

**€ 12,20**

TRANSPARENT

a pezzo  
for piece



L85 x H146

Protezione serbatoio mni  
Mini tank protection sticker

STK100

**€ 12,20**

METALLIC BLACK

a pezzo  
for piece



L85 x H146

Protezione serbatoio mini  
Mini tank protection sticker

STK101

**€ 12,20**

CARBON TEXTURE

a pezzo  
for piece



L110 x H205

Protezione serbatoio doppio  
Double tank protection sticker

STK102

€ 12,30

TRANSPARENT

a pezzo  
for piece



L110 x H205

Protezione serbatoio doppio  
Double tank protection sticker

STK103

€ 12,30

METALLIC BLACK

a pezzo  
for piece



L110 x H205

Protezione serbatoio doppio  
Double tank protection sticker

STK104

€ 12,30

CARBON TEXTURE

a pezzo  
for piece



L115 x H165

Protezione serbatoio slim short  
Slim short tank protection sticker

STK105

€ 12,20

TRANSPARENT

a pezzo  
for piece



L115 x H165

Protezione serbatoio slim short  
Slim short tank protection sticker

STK106

€ 12,20

METALLIC BLACK

a pezzo  
for piece



L115 x H165

Protezione serbatoio slim short  
Slim short tank protection sticker

STK107

€ 12,20

CARBON TEXTURE

a pezzo  
for piece



L135 x H170

Protezione serbatoio centrale  
Central tank protection sticker

STK112

€ 7,40

Basso spessore 0,3 mm - Low thickness 0.3 mm

a pezzo  
for piece



L135 x H170

Protezione serbatoio centrale  
Central tank protection sticker

STK111

€ 7,40

Basso spessore 0,3 mm - Low thickness 0.3 mm

a pezzo  
for piece

# ADESIVO PER SERBATOIO

220 TANK PAD

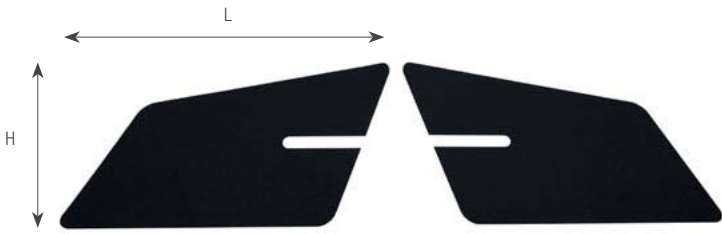

L210 x H114

STK114

€ 22,20

Kit adesivi protezioni serbatoio (laterali) spessore 0.3 mm  
Tank protection stickers kit (sides) 0.3 mm thickness

a kit - for kit



L210 x H114

STK115

€ 22,20

Kit adesivi protezioni serbatoio (laterali) spessore 0.3 mm  
Tank protection stickers kit (sides) 0.3 mm thickness

a kit - for kit



25 x 60 mm

STK116

€ 6,30

Velcro biadesivo 3M  
3M velcro double-side

a kit - for kit



20 x 60 mm

STK117

€ 10,80

Velcro biadesivo 3M  
3M velcro double-side

a kit - for kit



50 x 50 mm

STK120

€ 7,00

a kit - for kit

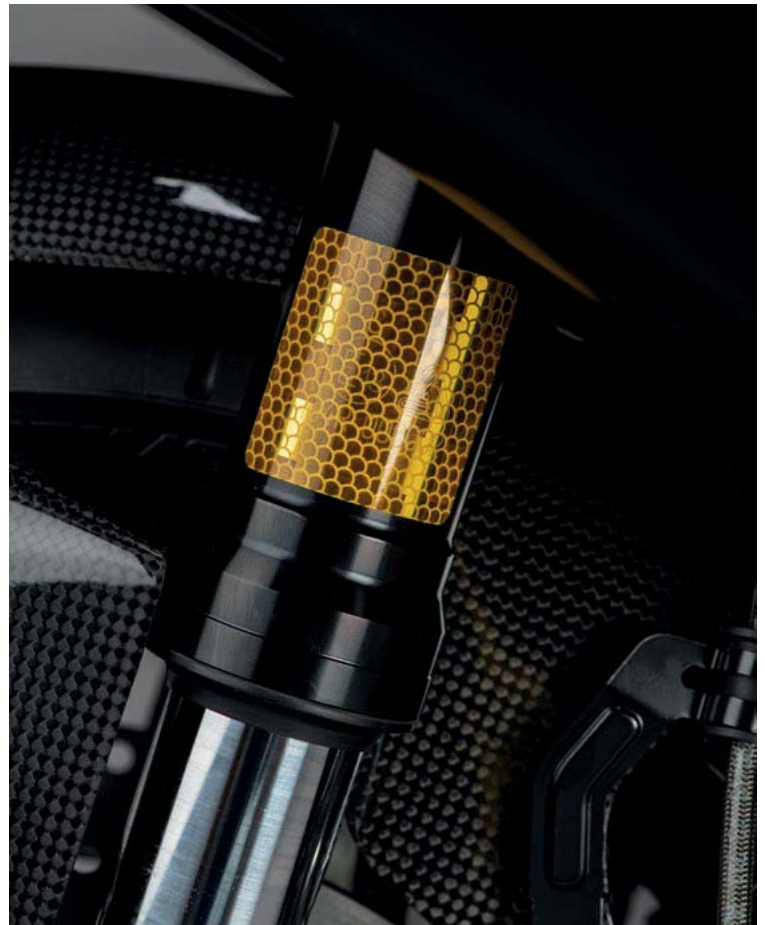



L 7000x7mm



white race

blue race

yellow race

red race

green race

orange race

orange ktm

| Adesivi per profili ruota - Wheel stickers |             |        | a pezzo<br>for piece |
|--|-------------|--------|----------------------|
| Adesivi per profili ruota - Wheel stickers | white race  | STK047 | € 9,80               |
| Adesivi per profili ruota - Wheel stickers | blue race   | STK048 | € 9,80               |
| Adesivi per profili ruota - Wheel stickers | yellow race | STK049 | € 9,80               |
| Adesivi per profili ruota - Wheel stickers | red race    | STK050 | € 9,80               |
| Adesivi per profili ruota - Wheel stickers | green race  | STK051 | € 9,80               |
| Adesivi per profili ruota - Wheel stickers | orange race | STK052 | € 9,80               |
| Adesivi per profili ruota - Wheel stickers | orange ktm  | STK088 | € 9,80               |



STK118 € 21,50

Adesivi per profili ruota - Wheel stickers

a pezzo  
for piece

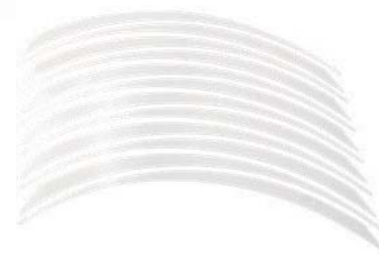
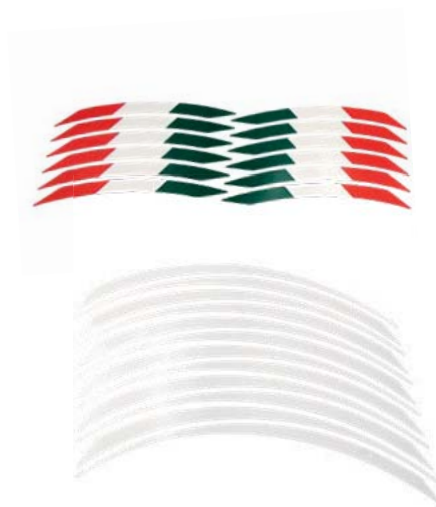

STK119 € 21,50

Adesivi per profili ruota - Wheel stickers

a pezzo  
for piece

## ADESIVI

222 STICKERS



L330 x H480

STK108

€ 10,5

Pellicola protettiva trasparente  
Transparent skin protection

a pezzo  
for piece



L350 x H500

STK109

€ 16,30

Protezione per alte temperature ( con adesivo )  
High-temperature protection (with sticker)

a pezzo  
for piece



L350 x H500

STK110

€ 11,70

Pellicola carbon texture  
Carbon skin texture

a pezzo  
for piece



330 x 330 x 15 mm

NSR01 € 14,00

Neoprene per sella  
Neoprene for racing seat

a pezzo - for piece

## COMUNICAZIONE E MERCHANDISING COMMUNICATION AND MERCHANDISING



Espositore da terra (65x200 cm · 27 kg)  
Floor display stand (65x200 cm · 27 kg)

EXP008

€ 166,00



**YAHAMA**  
T-MAX 560





# YAHAMA T-MAX 560

ISS114LA (left)  
ISS120RA (right)

OIL004

FTP022 (Adaptor)  
FTP100 (Footpeg)

STEYA109

KTARYA124

CARY4912 (SHINE)  
CARY4912M (MATT)

TEYA001

CARY4914 (SHINE)  
CARY4914M (MATT)



| ARTICOLO / ARTICLE  | DESCRIZIONE / DESCRIPTION  | anno / year | codice / code | €             |
|---|--|-------------|---------------|---------------|
| Pedane / Rear sets  | poggia piedi passeggero / passenger footpeg  | 2008 / 2021 | FTP022        | <b>29,00</b>  |
|   | adattatore per poggiapiedi / adaptor for footpeg   | 2008 / 2021 | FTP100        | <b>50,00</b>  |
| Tendicatena / Chain adjusters   | tendinghia / belt adjuster   | 2008 / 2021 | TEYA001       | <b>186,00</b> |
| Kit leve / Lever Kit  | kit leve - freno + frizione / lever kit - brake + clutch                                 | 2008 / 2021 | KLEV116J      | <b>166,00</b> |
|   | kit leve - freno + frizione "Alien" / lever kit - brake + clutch "Alien"                 | 2008 / 2021 | KLEV116K      | <b>181,00</b> |
| Leve stazionamento / Parking braker levers                              | leve stazionamento / parking braker levers   | 2008 / 2021 | LEVD014       | <b>59,00</b>  |
| Protezioni leve<br>Lever guards   | protezione leva freno destro in alluminio / aluminium right brake lever guard            | 2002 / 2021 | ISS120RA      | <b>106,00</b> |
|   | protezione leva freno sinistro in alluminio / aluminium left brake lever guard           | 2002 / 2021 | ISS114LA      | <b>106,00</b> |
|   | adattatore per protezione leva / lever guard adaptor                                     | 2002 / 2021 | KPL310        | <b>24,00</b>  |
| Contrappesi manubri<br>Handlebar balancers                              |  | 2002 / 2021 | KTM410        | <b>24,00</b>  |
|   | Devil series   | 2002 / 2021 | KTM310        | <b>36,50</b>  |
|   |  | 2002 / 2021 | KTM210        | <b>33,00</b>  |
| Specchietti / Mirrors   | coppia specchi in alluminio, fissaggio a manubrio / Pair of mirrors, fixing on handlebar | 2008 / 2021 | SPEAL015      | <b>207,00</b> |
|   | coppia specchi in alluminio, fissaggio su carena / pair of mirrors, fixing on fairing    | 2012 / 2021 | SPEAL019      | <b>277,00</b> |
| Tappi specchio / Mirror block-off plates                                | tappi specchio / mirror block-off plates   | 2012 / 2021 | SPEY08        | <b>49,00</b>  |
| Portatarga / License plate  | kit portatarga (T-Max 530 / 560) / license plate kit (T-Max 530 / 560)                   | 2017 / 2021 | KTARYA124     | <b>92,00</b>  |
|   | kit portatarga / license plate kit   | 2012 / 2016 | KTARYA114     | <b>92,00</b>  |
| T - Max 500 (with undertail)  |  | 2008 / 2011 | KTARYA112     | <b>117,00</b> |
| T - Max 500 (without undertail)   |  | 2008 / 2011 | KTARYA113     | <b>92,00</b>  |
| Protezioni perni ruota / Wheel axle sliders                             | kit protezioni perni ruota / wheel axle sliders kit                                      | 2015 / 2021 | WAPYA409      | <b>68,00</b>  |
| Tappi olio / Oil filter caps  |  | 2014 / 2021 | OIL004        | <b>20,00</b>  |
| Coperchi pompe freno e frizione /<br>Clutch/brake pump reservoir covers | freno / brake  | 2008 / 2021 | FBC15         | <b>29,00</b>  |
| Copricarter / Carter protector  |  | 2017 / 2021 | ECPYA010      | <b>192,00</b> |
| Copri perno forcellone / Swingarm pivot cover                           |  | 2012 / 2021 | STEYA109      | <b>78,00</b>  |
| Fondello terminale di scarico<br>Exhaust end                            |  | 2008 / 2016 | TEX001        | <b>33,00</b>  |
| Distanziali sella pilota<br>Spacers for rider's back-seat               |  | 2008 / 2016 | TSR001        | <b>27,00</b>  |
| Paratacco su scarico / Heel guard                                       |  | 2012 / 2016 | STEYA110      | <b>39,50</b>  |
| Parti in carbonio lucido<br>Shine carbon parts                          | copri cinghia superiore / upper belt cover   | 2017 / 2021 | CARY4912      | <b>184,00</b> |
|   | copri cinghia inferiore / lower belt cover   | 2017 / 2021 | CARY4914      | <b>173,00</b> |
|   | parafango ant. / front mudguard  | 2012 / 2014 | CARY4610      | <b>168,00</b> |
|   | parafango ant. / front mudguard  | 2015 / 2016 | CARY4710      | <b>168,00</b> |
|   | protezioni forcellone / swingarm protector   | 2012 / 2016 | CARY4660      | <b>144,00</b> |
|   | copri cinghia / belt protector   | 2012 / 2016 | CARY4612      | <b>108,00</b> |
| Parti in carbonio opaco<br>Matt carbon parts                            | copri cinghia superiore / upper belt cover   | 2017 / 2021 | CARY4912M     | <b>184,00</b> |
|   | copri cinghia inferiore / lower belt cover   | 2017 / 2021 | CARY4914M     | <b>173,00</b> |
|   | parafango ant. / front mudguard  | 2012 / 2014 | CARY4610M     | <b>184,80</b> |
|   | parafango ant. / front mudguard  | 2015 / 2016 | CARY4710M     | <b>184,80</b> |
|   | protezioni forcellone / swingarm protector   | 2012 / 2016 | CARY4660M     | <b>156,00</b> |
|   | copri cinghia / belt protector   | 2012 / 2016 | CARY4612M     | <b>120,00</b> |

Vanni Oddera  
Ph: Lorenzo Refrigeri

**BORN  
TO BE  
MOTO**



Vanni Oddera  
Ph: Lorenzo Refrigeri





## PICCOLI GRANDI EROI DELLA MOTO TERAPIA

### LITTLE BIG HEROES OF MOTORBIKE THERAPY

La moto è libertà, coraggio, adrenalina. Una scossa vitale che i nostri amici Vanni Odera e Massimo Bianconcini, con la loro "mototerapia", fanno provare anche ai più sfortunati, esibendosi con le loro due ruote addirittura tra i reparti di oncologia infantile... vi siamo vicini, siete straordinari!

Motorbike is freedom, brave, adrenalin. A life pulse that Vanni Oddera and Massimo Bianconcini, with their "MotoTherapy", want to donate to pediatric oncology departments. We are with you, you are amazing.



BORN  
TO BE  
MOTO



Jorge Navarro  
Team SpeedUp

## Condizioni generali di vendita

### PREZZI

I prezzi indicati nel catalogo sono tasse escluse.

### TRASPORTO

Il trasporto dei nostri prodotti avviene tramite corriere e le spese di trasporto sono addebitate in fattura.

### TEMPI E MODALITÀ DI CONSEGNA

La consegna dei prodotti viene normalmente assicurata entro 2/3 giorni dal ricevimento dell'ordine per l'Italia e pianificata nel resto del Mondo in base alla disponibilità del prodotto ed alle esigenze del Cliente/Distributore in accordo con LighTech.

LighTech® viene distribuita in tutto in tutto il Mondo tramite la propria rete vendita.

### RESO MERCE

Nella remota eventualità che il cliente riceva un prodotto che presenti difettosità o anomalie rispetto a quanto ordinato, il cliente dovrà entro 5 gg. lavorativi dalla data di ricezione merce informare il Servizio Clienti LighTech all'indirizzo mail sales@lightech.it per ricevere istruzioni dettagliate sulla modalità dell'eventuale reso prodotto e relativa sostituzione/nota di accredito.

### MINIMO D'ORDINE

L'importo minimo dell'ordine deve essere uguale o maggiore di € 70 al netto degli sconti e spese accessorie, fatto salvo diverse le condizioni accordate con LighTech al momento della stipula del contratto.

### MARCHI

I seguenti marchi registrati con i nomi: Aprilia®, BMW®, Ducati®, Honda®, Kawasaki®, Mv Agusta®, Suzuki®, Triumph®, Yamaha® sono di proprietà delle rispettive Case e vengono qui utilizzati a solo titolo descrittivo.

### AGGIORNAMENTI AL CATALOGO

LighTech si riserva la facoltà di apportare aggiornamenti migliorativi ai prodotti ed al loro aggiornamento applicativo in qualsiasi momento e senza preavviso.

### AVVERTENZE

I prodotti LighTech® sono stati progettati e realizzati per l'utilizzazione in ambiti agonistici. LighTech® non si assume pertanto alcuna responsabilità per un eventuale uso non corretto e responsabile dei propri prodotti.

### INFORMAZIONE SUI PRODOTTI

Tutti gli articoli inseriti nel catalogo realizzati in leghe leggere vengono prodotti in Italia presso gli stabilimenti della LighTech.

Tutte le fotografie, le informazioni e le schede tecniche che illustrano i prodotti e le loro caratteristiche tecniche, sono di proprietà esclusiva della LighTech srl.

### CONTROVERSIE E RESPONSABILITÀ

Le presenti condizioni generali di vendita sono regolate dalle leggi Italiane. Per qualsiasi controversia relativa alla validità, interpretazione o esecuzione delle medesime, la competenza territoriale è quella della città di Treviso in Italia.

## Sales conditions

### PRICES

The prices on the catalogue are in € currency, VAT excluded.

### TRANSPORT

The transport is by express courier and shipping costs are charged in the invoice.

### DELIVERY TIMES AND TERMS

Normally delivery times are within 2/3 working days from the receipt of the order for Italy. For the rest of the World, delivery times are planned based on product availability and the needs of Dealer / Distributor in agreement with LighTech.

LighTech® is distributed worldwide through its own sales network.

### RETURNS GOODS

In the event that the customer receives a product that has defects or anomalies with respect to what was ordered, the customer must inform LighTech Customer Service within 5 working days by writing to sales@lightech.it providing details on the goods ordered, invoice number and reasons for complaint, along with pictures whenever possible.

The customer will receive detailed information on terms and conditions for the possible return of the product and for its replacement or credit note.

### MINIMUM ORDER

The minimum order amount must be equal to or greater than € 70 net of discounts, taxes and shipping costs, unless otherwise agreed with LighTech at the time of signing the contract.

### TRADEMARK

Aprilia®, BMW®, Ducati®, Honda®, Kawasaki®, Mv Agusta®, Suzuki®, Triumph®, Yamaha® are registered Trademarks, here used only as a reference.

### CATALOG UPDATES

LighTech® reserves the right to make improvements to the products and their applications at any time and without notice.

### WARNINGS

LighTech® products have been designed and manufactured for agonistic use. LighTech® is therefore not responsible for any improper use of its products.

### PRODUCT INFORMATION

All LighTech products included in the catalog are made of light alloys and are produced in Italy at LighTech factories.

Each photos and information present in the catalog are owned by LighTech srl. All rights reserved.

### DISPUTES AND LIABILITY

These general sales conditions are governed by Italian laws. For any dispute relating to the validity, interpretation or execution of the same, the territorial jurisdiction is that of the city of Treviso in Italy.









MADE IN ITALY



Ligtech srl  
Via Serenissima, 11  
31025 S. Lucia di Piave (TV)

Tel. +39 0438 453010  
Fax +39 0438 655919

info@lightech.it  
[www.lightech.it](http://www.lightech.it)



LighTech Racing



Ligtech\_official



@LighTech\_Racing